



Chipsmall Limited consists of a professional team with an average of over 10 year of expertise in the distribution of electronic components. Based in Hongkong, we have already established firm and mutual-benefit business relationships with customers from,Europe,America and south Asia,supplying obsolete and hard-to-find components to meet their specific needs.

With the principle of "Quality Parts,Customers Priority,Honest Operation,and Considerate Service",our business mainly focus on the distribution of electronic components. Line cards we deal with include Microchip,ALPS,ROHM,Xilinx,Pulse,ON,Everlight and Freescale. Main products comprise IC,Modules,Potentiometer,IC Socket,Relay,Connector.Our parts cover such applications as commercial,industrial, and automotives areas.

We are looking forward to setting up business relationship with you and hope to provide you with the best service and solution. Let us make a better world for our industry!



Contact us

Tel: +86-755-8981 8866 Fax: +86-755-8427 6832

Email & Skype: info@chipsmall.com Web: www.chipsmall.com

Address: A1208, Overseas Decoration Building, #122 Zhenhua RD., Futian, Shenzhen, China



VTM™ Transformer

- Isolated 1-50 Vout
- High density
- Small footprint
- ZVS / ZCS Sine Amplitude Converter™
- 3 MHz effective switching frequency
- Surface-mount package
- Low weight
- -55°C to 125°C operation
- 1 μs transient response
- 4.5 million hours MTBF
- Up to 96.5% efficiency

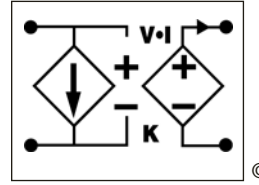

Product Description

The VTM Transformer is a V·I Chip™ product that provides extremely fast, efficient, and quiet fixed ratio voltage division (or current multiplication). With twelve voltage division ratios from 1:1 to 1:32, the isolated VTM provides the user with the flexibility to supply up to 100 A or 120 W at any output voltage from 1 to 50 Vdc in a surface mount package occupying ~1 square inch.

The Military VTMs are optimized for use with the Military PRM™ Regulator to implement a Factorized Power Architecture™ (FPA™). Together, the PRM + VTM chip set provides the full functionality of a DC-DC converter, but with breakthrough performance and flexibility in a rugged, miniature package. The companion PRM for the MV036 family of VTMs is the 28 Vdc input MP028F036M12AL, which operates from an input range of 16-50 Vdc (the data sheet is available at vicorpower.com). The VTM can also be used as a standalone POL product.

By factorizing the DC-DC power conversion into its essential elements – the VTM’s isolation and transformation on the one hand, and the PRM’s output voltage control and regulation on the other – and arranging those functions in a sequence that maximizes system performance, FPA offers a fundamentally new and significantly improved approach to power conversion.

The VTM’s fast dynamic response and low noise eliminate the need for bulk capacitance at the load, substantially increasing the POL density while improving reliability and decreasing cost. The low profile VTM (0.265 inches, 6,73 mm) is available with J-leads for surface mount or pins for through hole applications.

Absolute Maximum Ratings

| Parameter | Values | Unit | Notes |
|-----------------------------------------------|----------------|------|-----------------|
| +In to -In | -1.0 to 60 | Vdc | |
| | 100 | Vdc | For 100 ms |
| PC to -In | -0.3 to 7.0 | Vdc | |
| VC to -In | -0.3 to 19.0 | Vdc | |
| +Out to -Out | Model specific | Vdc | Contact factory |
| Isolation voltage | 2,250 | Vdc | Input to Output |
| Output current | Model specific | A | See Table 1 |
| Peak output current | 1.5 • Iout | A | For 1 ms |
| Output power | 120 | W | |
| Peak output power | 180 | W | For 1 ms |
| Case temperature | 225 | °C | MSL 5 |
| | 245 | °C | MSL 6 |
| Operating junction temperature ^[a] | -55 to 125 | °C | M - Grade |
| Storage temperature | -65 to 125 | °C | M - Grade |

Note:

[a] The referenced junction is defined as the semiconductor having the highest temperature. This temperature is monitored by a shutdown comparator.

Part Numbering Format

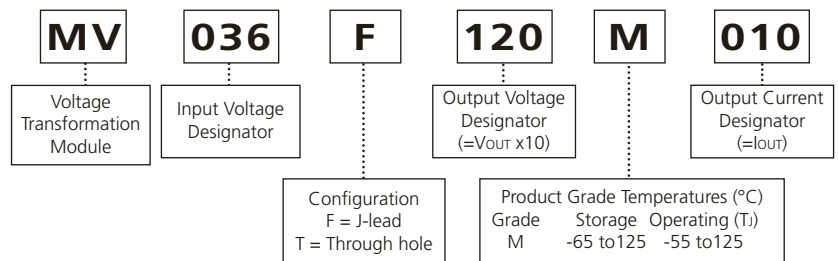

Electrical Specifications

Input Specs (Conditions are at 36 V_{in}, full load, and 25°C ambient unless otherwise specified)

| Parameter | Min | Typ | Max | Unit | Note |
|----------------------------|------|------|------|-----------------|-------------------------------------------------|
| Input voltage range | 26 | 36 | 50 | V _{dc} | Operable down to zero V with VC voltage applied |
| Input dV/dt | | | 1 | V/μs | |
| Input overvoltage turn-on | 50.5 | 54.4 | | V _{dc} | |
| Input overvoltage turn-off | | 55.5 | 57.5 | V _{dc} | |
| Input current | | | 3.5 | A _{dc} | Continuous |
| No load power dissipation | 1.5 | 3.0 | 6.0 | W | Low line to high line |

Output Specs (Conditions are at 36 V_{in}, full load, and 25°C ambient unless otherwise specified)

| Parameter | Min | Typ | Max | Unit | Note |
|-------------------------------|-------------------------------------------|------|-----------------------|-----------------------|-----------------------------------------------------------------|
| Output voltage | See Table 1 | | | V _{dc} | No load |
| | $K \cdot V_{IN} - I_o \cdot R_{OUT\ NOM}$ | | | V _{dc} | Full load |
| Rated DC current | 0 | | 100 | A _{dc} | 26 - 50 V _{IN} See Table 1 |
| Peak repetitive current | | | 150% | I _{MAX} (A) | Max pulse width 1ms, max duty cycle 10%, baseline power 50% |
| DC current limit | | 160% | | I _{NOM} (A) | Module will shut down when current limit is reached or exceeded |
| Current share accuracy | | 5 | 10 | % | |
| Efficiency | | | | | See Table 2, Page 3 |
| Load capacitance | | | | | See Table 2 when used with PRM |
| Output overvoltage setpoint | | 110% | 115% | V _{OUT\ MAX} | |
| Output ripple voltage (typ) | | | | | |
| No external bypass | 50 | | 250 | mV | See Figures 2 and 5 |
| 10 μF bypass capacitor | 2 | | 20 | mV | See Figure 6 |
| Effective switching frequency | 2.5 | 3.0 | 3.6 | MHz | Model dependent |
| Line regulation | 0.99K | K | 1.01K | | V _{OUT} = K • V _{IN} at no load, See Table 1 |
| Load regulation | R _{OUT\ MIN} | | R _{OUT\ MAX} | mΩ | See Table 1 |
| Transient response | | | | | |
| Response time | | 200 | | ns | See Figures 7 and 8 |
| Recovery time | | 1 | | μs | See Figures 7 and 8 |

Military Cots VTM Family Part Numbers and Ranges

| Part Number | K-Factor | Rated Output Current (A) | No Load Output Voltage (Vdc) | | Rout (mΩ) | | |
|----------------|----------|--------------------------|------------------------------|-------------|-----------|------|------|
| | | | @26 Vin | @ 50 Vin | Min | Nom | Max |
| MV036F011M100 | 1/32 | 100 | 0.82 | 1.55 | 0.5 | 0.85 | 1.3 |
| MV036F015M080 | 1/24 | 80 | 1.1 | 2.0 | 1.0 | 1.25 | 1.5 |
| MV036F022M055 | 1/16 | 55 | 1.63 | 3.1 | 1.4 | 1.75 | 2.0 |
| MV036F030M040 | 1/12 | 40 | 2.2 | 4.1 | 1.45 | 2.4 | 3.4 |
| MV036F045M027 | 1/8 | 27 | 3.3 | 6.2 | 3.5 | 5.1 | 6.6 |
| MV036F060M020 | 1/6 | 20 | 4.3 | 8.3 | 5.0 | 8.0 | 10 |
| MV036F072M017* | 1/5 | 16.6 | 6.4* | 10 | 6.0 | 9.6 | 12 |
| MV036F090M013 | 1/4 | 13.3 | 6.5 | 12.5 | 6.9 | 9.3 | 11.6 |
| MV036F120M010 | 1/3 | 10.0 | 8.7 | 16.6 | 25 | 31 | 35 |
| MV036F180M007 | 1/2 | 6.7 | 13 | 25 | 27.5 | 35.7 | 46.4 |
| MV036F240M005 | 2/3 | 5.0 | 17.4 | 33 | 49.3 | 70.6 | 91.8 |
| MV036F360M003 | 1 | 3.3 | 26 | 50 | 140 | 170 | 200 |

Table 1 — VTM part numbers

* Low line input voltage 32 V

| Part Number | Typical Full Load Efficiency at nom Vout (%) | Typical Half Load Efficiency at nom Vout (%) | Maximum Load Capacitance (μF) |
|---------------|----------------------------------------------|----------------------------------------------|-------------------------------|
| MV036F011M100 | 89.5 | 91.5 | 48128 |
| MV036F015M080 | 92 | 94 | 27072 |
| MV036F022M055 | 94 | 94.5 | 12032 |
| MV036F030M040 | 94 | 95.0 | 6768 |
| MV036F045M027 | 95.3 | 96.5 | 3008 |
| MV036F060M020 | 95.3 | 96.8 | 1692 |
| MV036F072M017 | 96.5 | 96.5 | 1175 |
| MV036F090M013 | 96.3 | 95.5 | 752 |
| MV036F120M010 | 95.5 | 95.5 | 423 |
| MV036F180M007 | 96.0 | 95.2 | 188 |
| MV036F240M005 | 95.0 | 94.8 | 106 |
| MV036F360M003 | 96 | 96 | 47 |

Table 2 — Typical efficiency and maximum load capacitance, by part number

Control Pin Functions

VC – VTM Control

The VC port is multiplexed. It receives the initial Vcc voltage from an upstream PRM, synchronizing the output rise of the VTM with the output rise of the PRM. Additionally, the VC port provides feedback to the PRM to compensate for the VTM output resistance. In typical applications using VTMs powered from PRMs, the PRM’s VC port should be connected to the VTM VC port.

In applications where a VTM is being used without a PRM, 14 V must be supplied to the VC port for as long as the input voltage is below 26 V and for 10 ms after the input voltage has reached or exceeded 26 V. The VTM is not designed for extended operation below 26 V. The VC port should only be used to provide Vcc voltage to the VTM during startup.

PC – Primary Control

The Primary Control (PC) port is a multifunction port for controlling the VTM as follows:

Disable – If PC is left floating, the VTM output is enabled. To disable the output, the PC port must be pulled lower than 2.4 V, referenced to -In. Optocouplers, open collector transistors or relays can be used to control the PC port. Once disabled, 14 V must be re-applied to the VC port to restart the VTM.

Primary Auxiliary Supply – The PC port can source up to 2.4 mA at 5 Vdc.

Waveforms

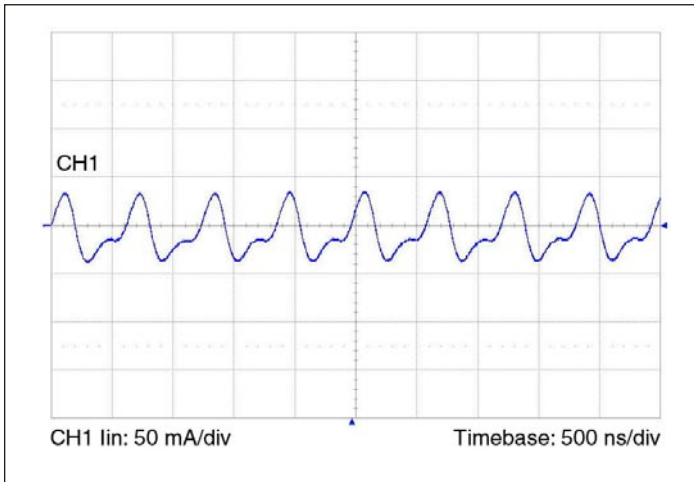

Figure 1 — Representative input reflected ripple current at full load (MV036F120M010).

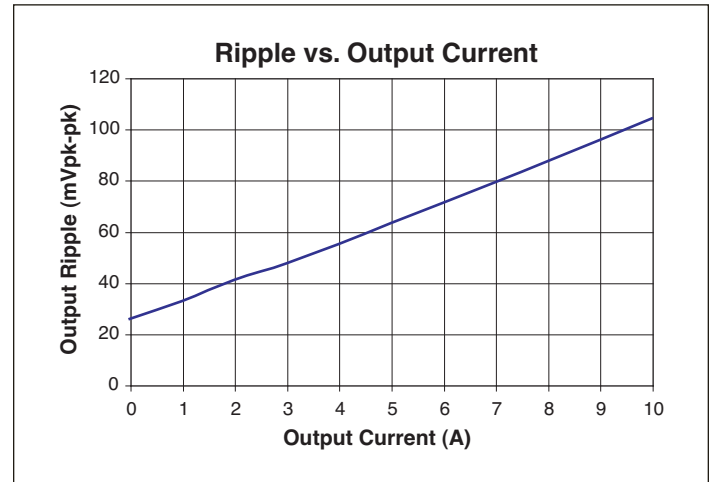

Figure 2 — Sample output voltage ripple vs. output current with no POL bypass capacitance (MV036F120M010).

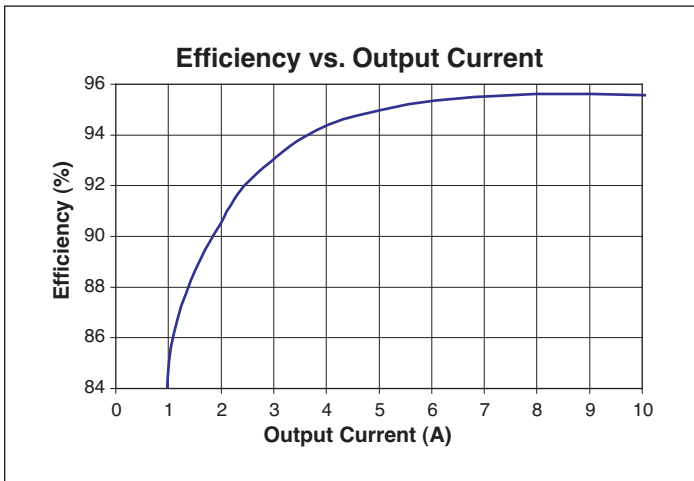

Figure 3 — Representative efficiency vs. output current (MV036F120M010).

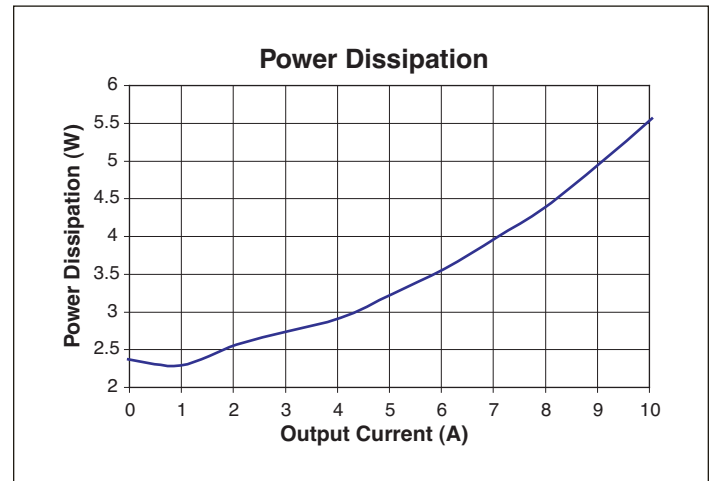

Figure 4 — Example power dissipation vs. output current (MV036F120M010).

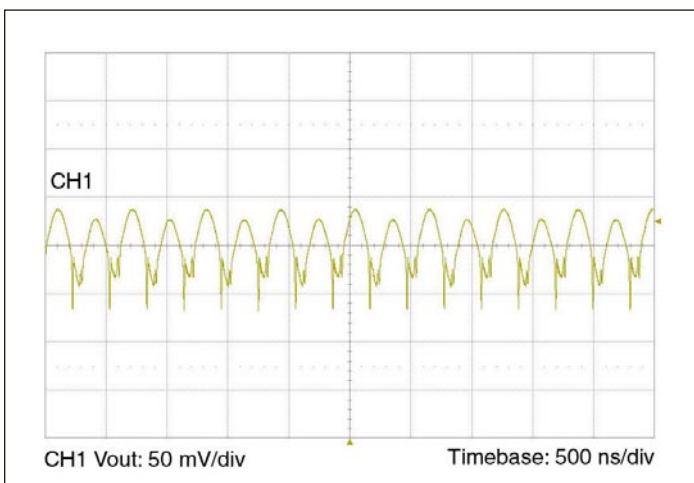

Figure 5 — Sample output voltage ripple at full load; with no POL bypass capacitance (MV036F120M010).

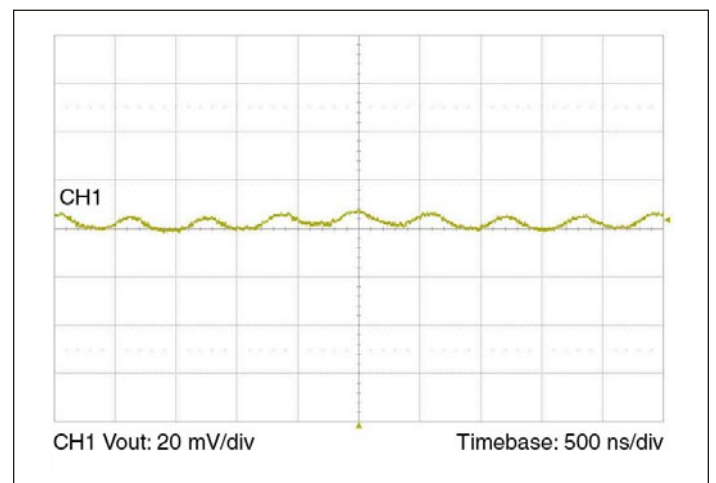

Figure 6 — Sample output voltage ripple at full load with 4.7 μ F ceramic POL bypass capacitance and 20 nH distribution inductance (MV036F120M010).

Electrical Specifications (continued)

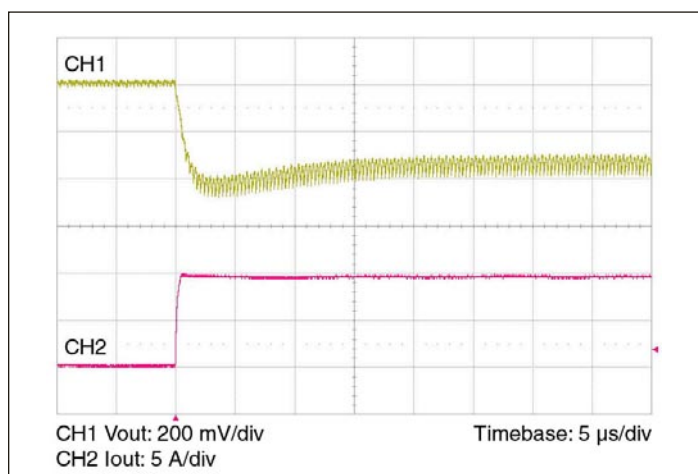

Figure 7 — Example load step with 100 μF input capacitance and no output capacitance (MV036F120M010).

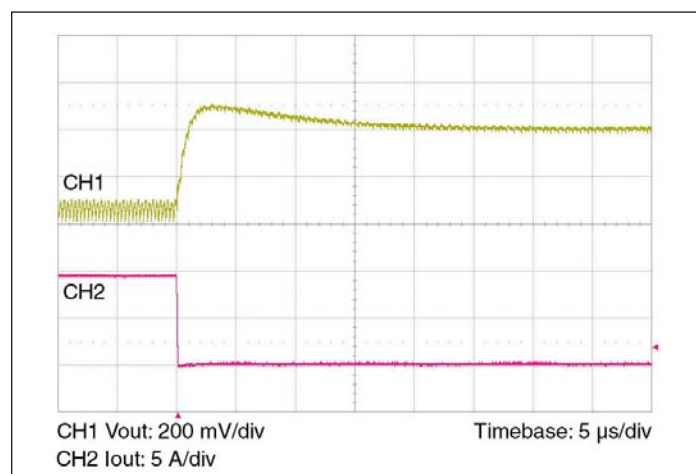

Figure 8 — Example load step with 100 μF input capacitance and no output capacitance (MV036F120M010).

General

| Parameter | Min | Typ | Max | Unit | Note |
|---------------------------------------------------------|-------|------------|-----|-------|------------------------------------------|
| MTBF (MV036F030M040) | | | | | |
| MIL-HDBK-217F | | 4,480,000 | | Hours | 25°C, GB |
| | | 806,000 | | | 50°C NS |
| | | 631,000 | | | 65°C AIC |
| Isolation specifications | | | | | |
| Voltage | 2,250 | | | Vdc | Input to Output |
| Capacitance | | 3000 | | pF | Input to Output |
| Resistance | 10 | | | MΩ | Input to Output |
| Agency approvals | | cTUVus | | | UL/CSA 60950-1, EN 60950-1 |
| | | CE Mark | | | Low voltage directive |
| Mechanical | | | | | |
| Weight | | 0.53/15 | | oz/g | See Mechanical Drawings, Figures 10 & 11 |
| Dimensions | | | | | |
| Length | | 1.28/32,5 | | in/mm | |
| Width | | 0.87/22 | | in/mm | |
| Height | | 0.265/6,73 | | in/mm | |
| Thermal | | | | | |
| Over temperature shutdown | 125 | 130 | 135 | °C | Junction temperature |
| Thermal capacity | | 9.3 | | Ws/°C | |
| Junction-to-case thermal impedance (R _{θjc}) | | 1.1 | | °C/W | |
| Junction-to-ambient | | 5.0 | | °C/W | With 0.25" heat sink* |
| Junction-to-board thermal impedance (R _{θjB}) | | 2.1 | | °C/W | |

Auxiliary Pins (Conditions are at 36 Vin, full load, and 25°C ambient unless otherwise specified)

| Parameter | Min | Typ | Max | Unit | Note |
|-------------------------|-----|-----|-----|------|----------------------------------------------------------------|
| Primary Control (PC) | | | | | |
| DC voltage | 4.8 | 5.0 | 5.2 | Vdc | |
| Module disable voltage | 2.4 | 2.5 | | Vdc | |
| Module enable voltage | | 2.5 | 2.6 | Vdc | VC voltage must be applied when module is enabled using PC |
| Current limit | 2.4 | 2.5 | 2.9 | mA | Source only |
| Disable delay time | | 6 | | μs | PC low to Vout low |
| VTM Control (VC) | | | | | |
| External boost voltage | 12 | 14 | 19 | Vdc | Required for VTM start up without PRM |
| External boost duration | | 10 | | ms | Vin > 26 Vdc. VC must be applied continuously if Vin < 26 Vdc. |

+In / -In DC Voltage Ports

The VTM input should not exceed the maximum specified. Be aware of this limit in applications where the VTM is being driven above its nominal output voltage. If less than 26 Vdc is present at the +In and -In ports, a continuous VC voltage must be applied for the VTM to process power. Otherwise VC voltage need only be applied for 10 ms after the voltage at the +In and -In ports has reached or exceeded 26 Vdc. If the input voltage exceeds the overvoltage turn-off, the VTM will shutdown. The VTM does not have internal input reverse polarity protection. Adding a properly sized diode in series with the positive input or a fused reverse-shunt diode will provide reverse polarity protection.

TM – For Factory Use Only

VC – VTM Control

The VC port is multiplexed. It receives the initial Vcc voltage from an upstream PRM, synchronizing the output rise of the VTM with the output rise of the PRM. Additionally, the VC port provides feedback to the PRM to compensate for the VTM output resistance. In typical applications using VTMs powered from PRMs, the PRM's VC port should be connected to the VTM VC port.

In applications where a VTM is being used without a PRM, 14 V must be supplied to the VC port for as long as the input voltage is below 26 V and for 10 ms after the input voltage has reached or exceeded 26 V. The VTM is not designed for extended operation below 26 V. The VC port should only be used to provide Vcc voltage to the VTM during startup.

PC – Primary Control

The Primary Control (PC) port is a multifunction port for controlling the VTM as follows:

Disable – If PC is left floating, the VTM output is enabled. To disable the output, the PC port must be pulled lower than 2.4 V, referenced to -In. Optocouplers, open collector transistors or relays can be used to control the PC port. Once disabled, 14 V must be re-applied to the VC port to restart the VTM.

Primary Auxiliary Supply – The PC port can source up to 2.4 mA at 5 Vdc.

+Out / -Out DC Voltage Output Ports

The output and output return are through two sets of contact locations. The respective +Out and -Out groups must be connected in parallel with as low an interconnect resistance as possible.

To take full advantage of the VTM, the user should note the low output impedance of the device. The low output impedance provides fast transient response without the need for bulk POL capacitance. Limited-life electrolytic capacitors required with conventional converters can be reduced or even eliminated, saving cost and valuable board real estate.

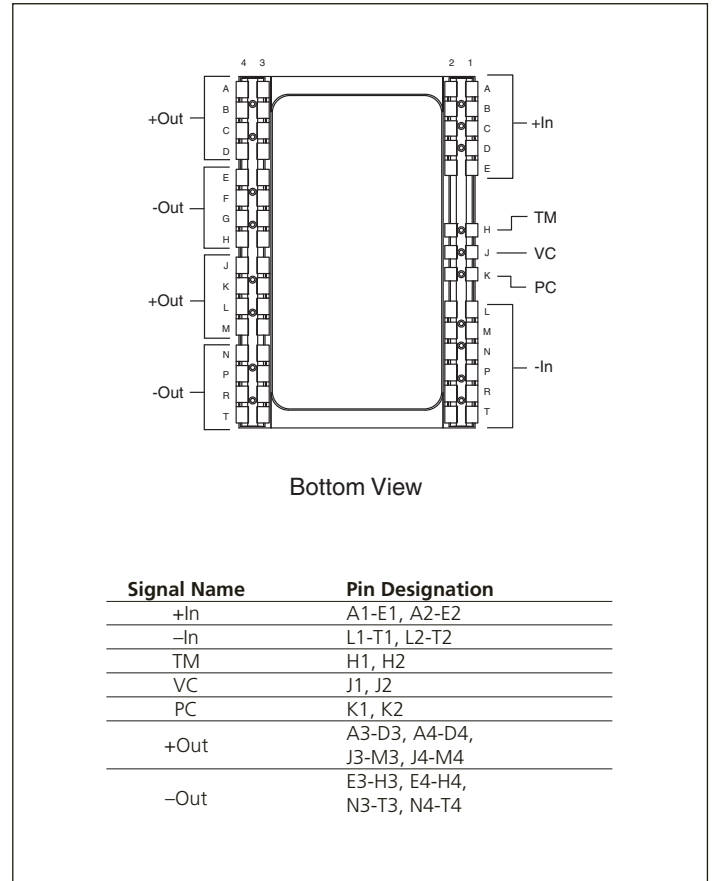

Figure 9 — VTM pin configuration

| Signal Name | Pin Designation |
|-------------|-------------------------------|
| +In | A1-E1, A2-E2 |
| -In | L1-T1, L2-T2 |
| TM | H1, H2 |
| VC | J1, J2 |
| PC | K1, K2 |
| +Out | A3-D3, A4-D4, J3-M3, J4-M4 |
| -Out | E3-H3, E4-H4, N3-T3, N4-T4 |

Mechanical Drawings

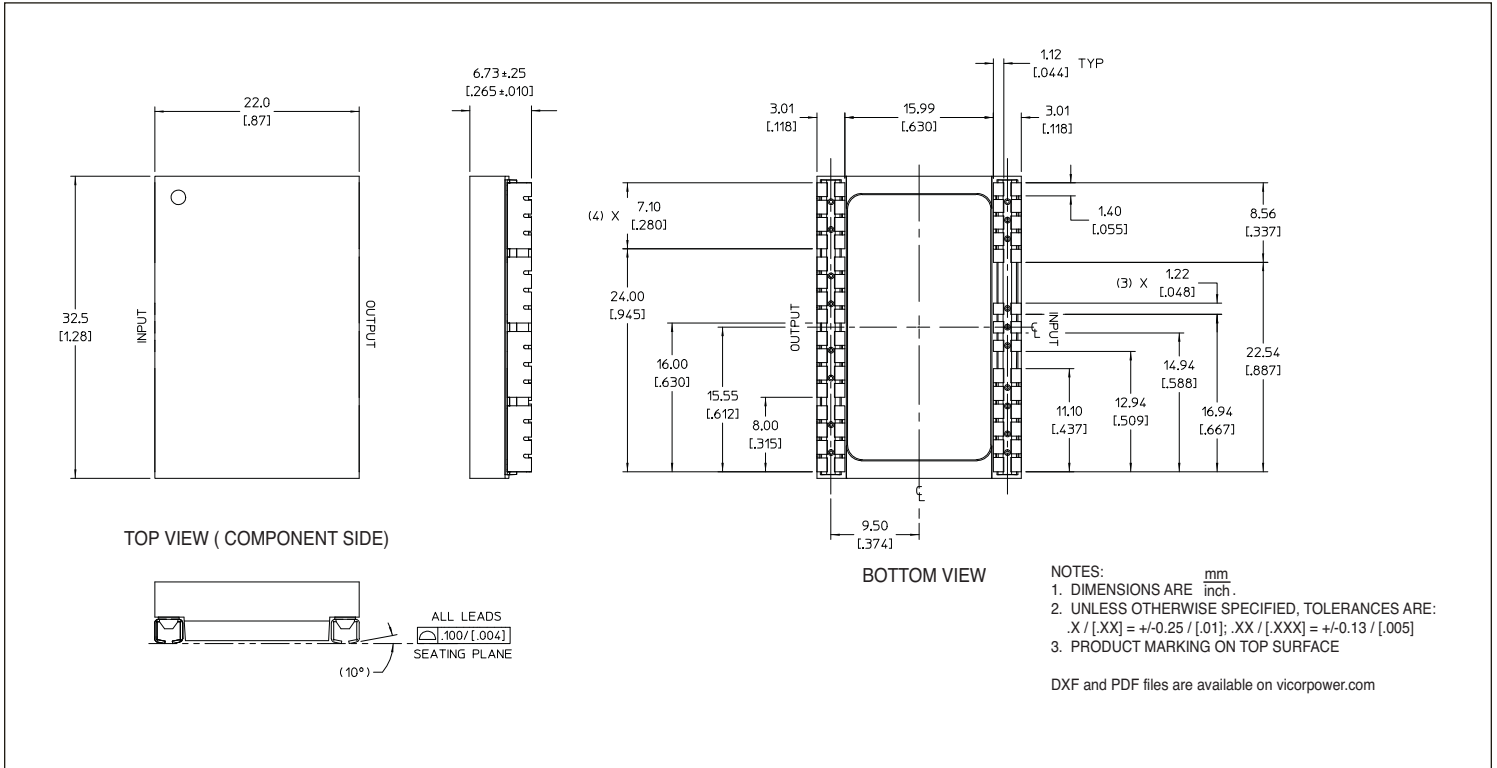

Figure 10 — VTM mechanical outline

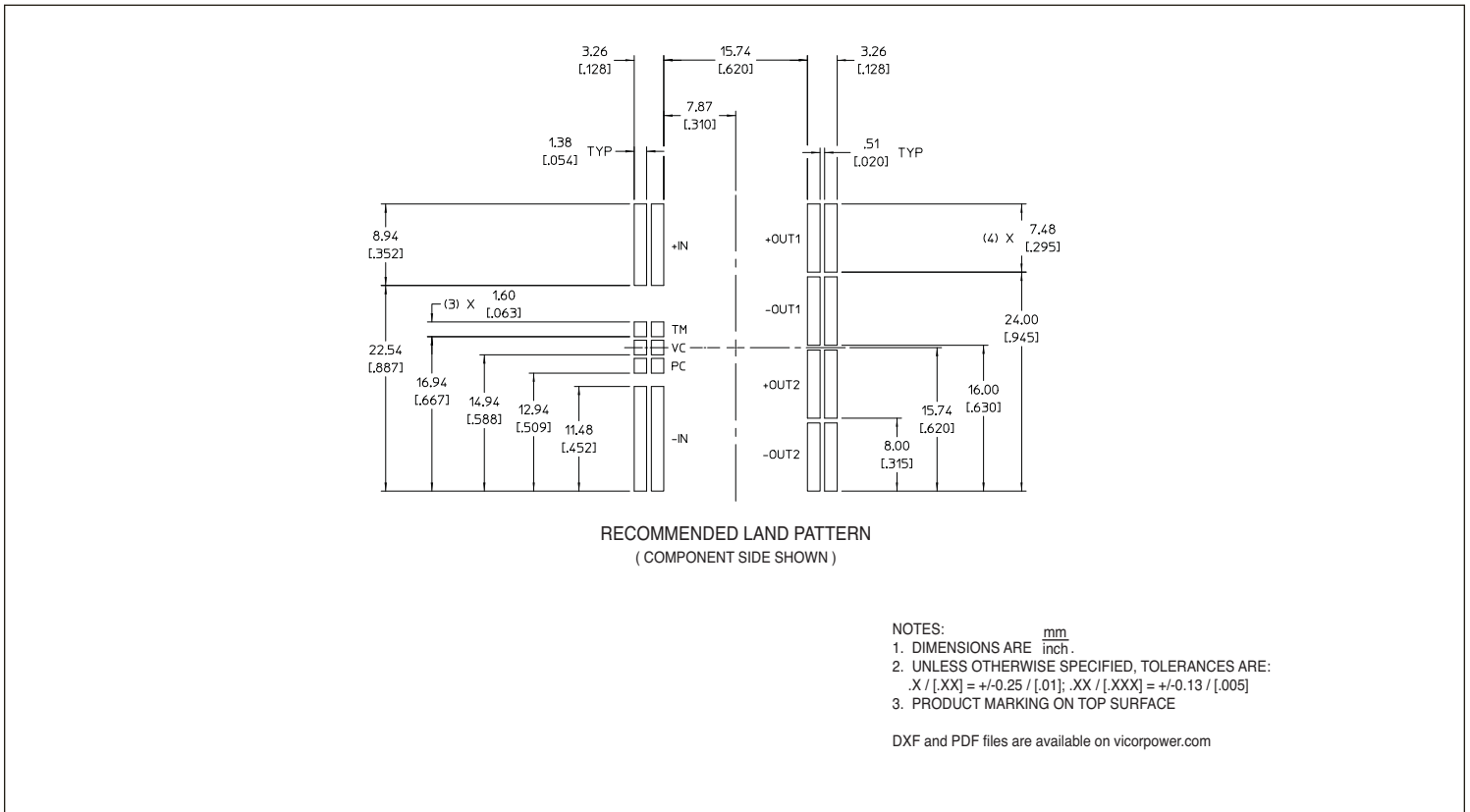

Figure 11 — VTM PCB land layout information

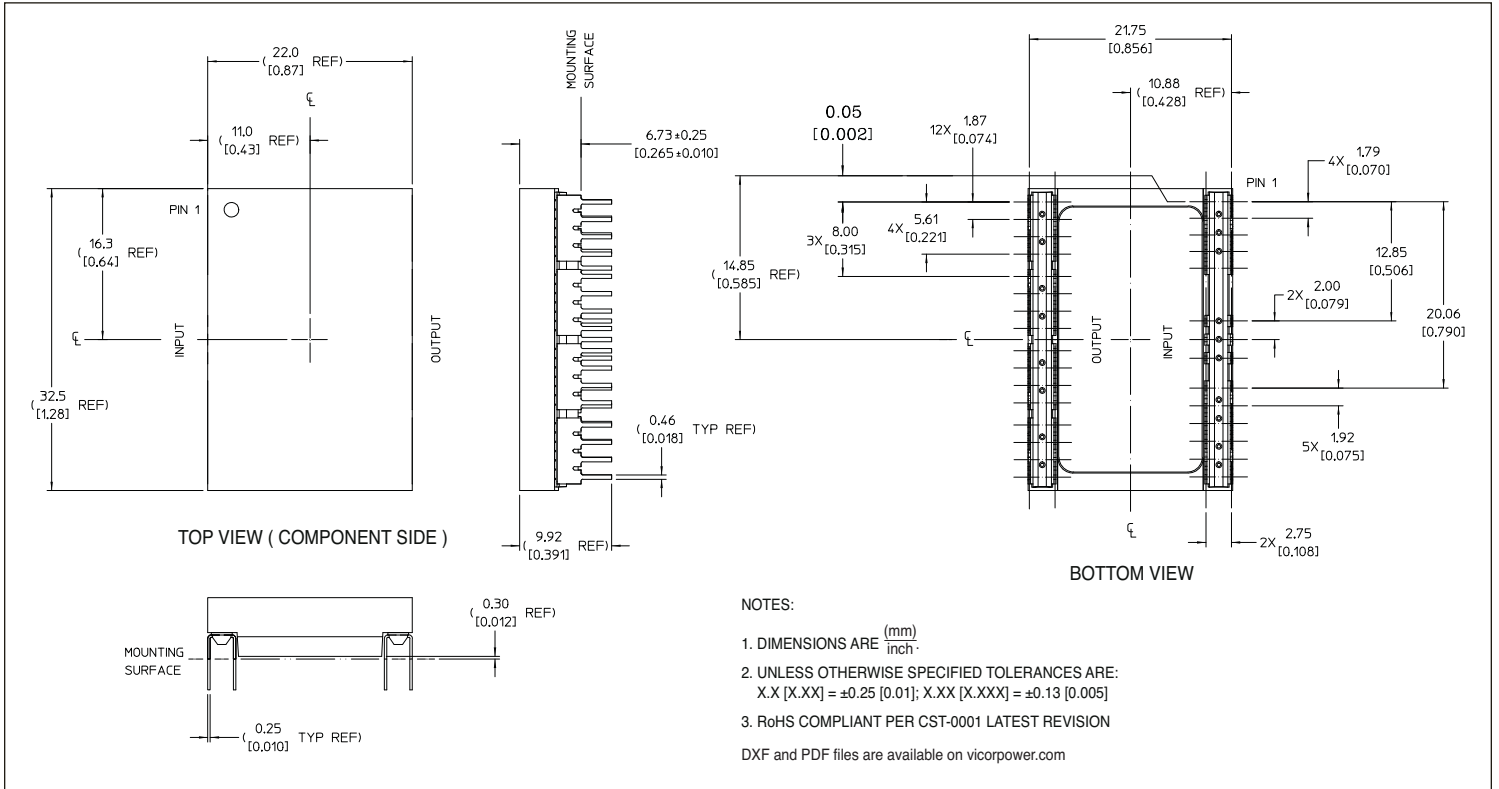

Figure 12 — VTM through-hole mechanical outline

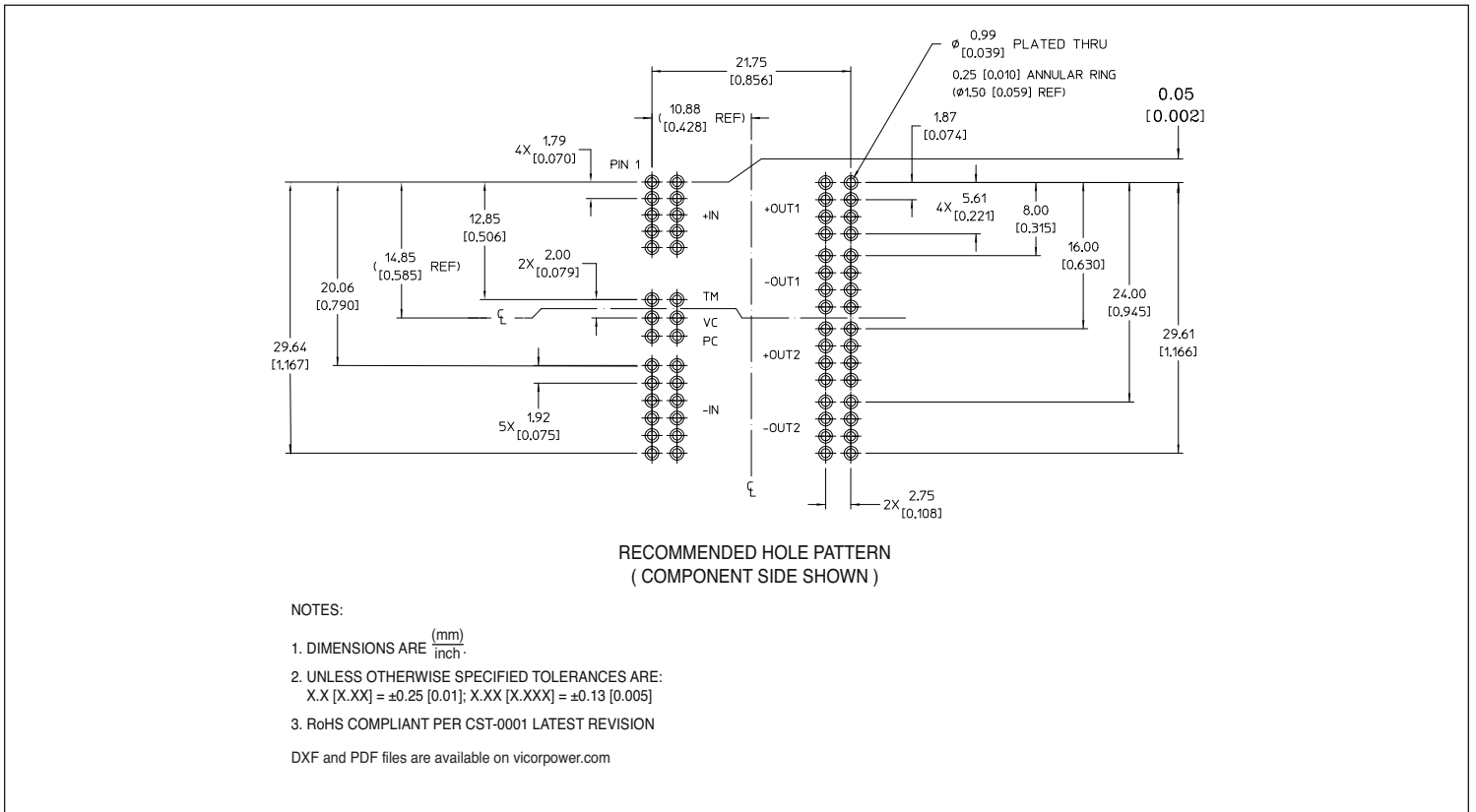

Figure 13 — VTM through-hole PCB layout information

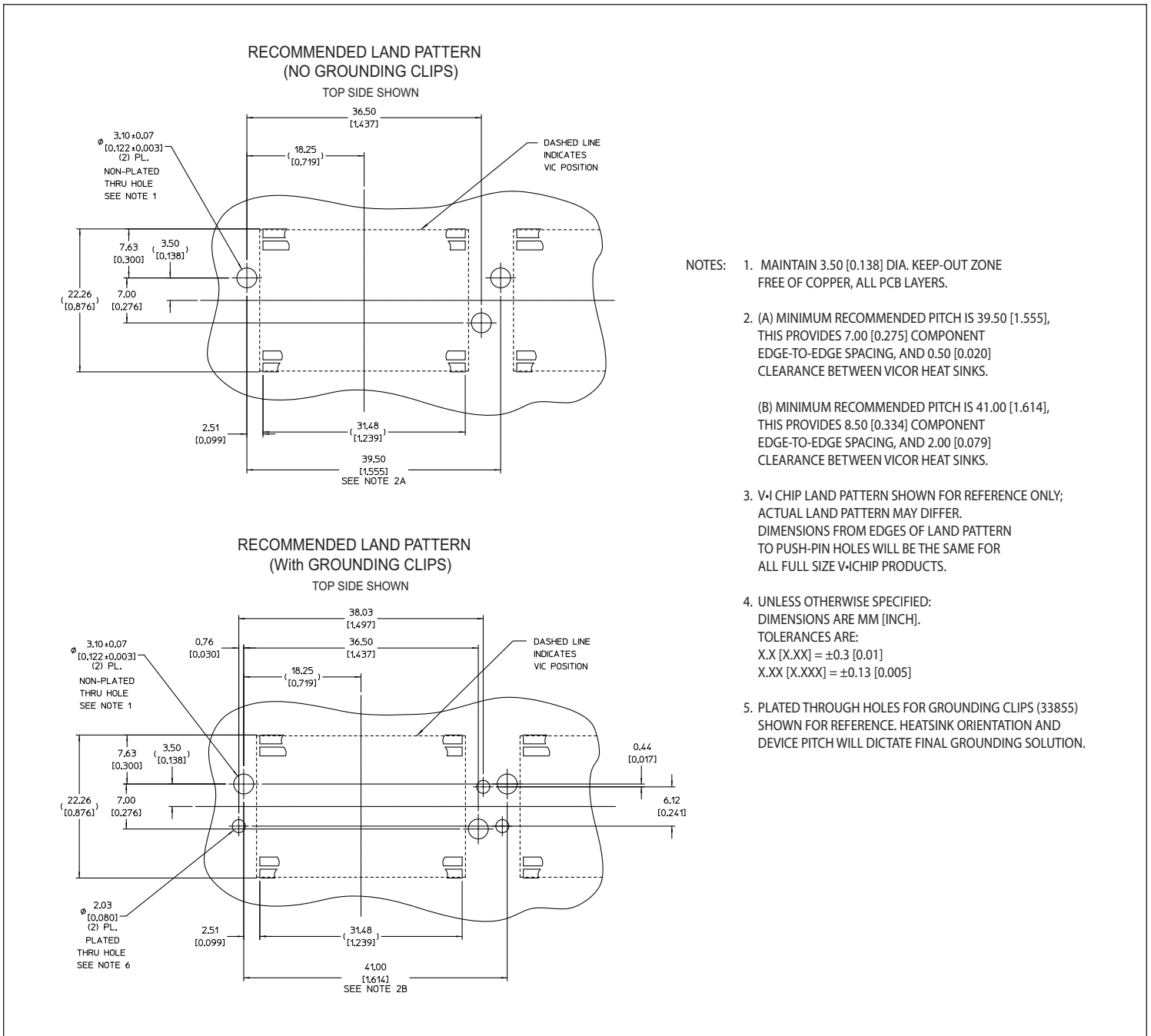

Figure 14 — Hole location for push pin heat sink relative to V-I Chip

Warranty

Vicor products are guaranteed for two years from date of shipment against defects in material or workmanship when in normal use and service. This warranty does not extend to products subjected to misuse, accident, or improper application or maintenance. Vicor shall not be liable for collateral or consequential damage. This warranty is extended to the original purchaser only.

EXCEPT FOR THE FOREGOING EXPRESS WARRANTY, VICOR MAKES NO WARRANTY, EXPRESS OR IMPLIED, INCLUDING, BUT NOT LIMITED TO, THE WARRANTY OF MERCHANTABILITY OR FITNESS FOR A PARTICULAR PURPOSE.

Vicor will repair or replace defective products in accordance with its own best judgement. For service under this warranty, the buyer must contact Vicor to obtain a Return Material Authorization (RMA) number and shipping instructions. Products returned without prior authorization will be returned to the buyer. The buyer will pay all charges incurred in returning the product to the factory. Vicor will pay all reshipment charges if the product was defective within the terms of this warranty.

Information published by Vicor has been carefully checked and is believed to be accurate; however, no responsibility is assumed for inaccuracies. Vicor reserves the right to make changes to any products without further notice to improve reliability, function, or design. Vicor does not assume any liability arising out of the application or use of any product or circuit; neither does it convey any license under its patent rights nor the rights of others. Vicor general policy does not recommend the use of its components in life support applications wherein a failure or malfunction may directly threaten life or injury. Per Vicor Terms and Conditions of Sale, the user of Vicor components in life support applications assumes all risks of such use and indemnifies Vicor against all damages.

Vicor's comprehensive line of power solutions includes high density AC-DC and DC-DC modules and accessory components, fully configurable AC-DC and DC-DC power supplies, and complete custom power systems.

Information furnished by Vicor is believed to be accurate and reliable. However, no responsibility is assumed by Vicor for its use. Vicor components are not designed to be used in applications, such as life support systems, wherein a failure or malfunction could result in injury or death. All sales are subject to Vicor's Terms and Conditions of Sale, which are available upon request.

Specifications are subject to change without notice.

Intellectual Property Notice

Vicor and its subsidiaries own Intellectual Property (including issued U.S. and Foreign Patents and pending patent applications) relating to the products described in this data sheet. Interested parties should contact Vicor's Intellectual Property Department.

The products described on this data sheet are protected by the following U.S. Patents Numbers: 5,945,130; 6,403,009; 6,710,257; 6,911,848; 6,930,893; 6,934,166; 6,940,013; 6,969,909; 7,038,917; 7,145,186; 7,166,898; 7,187,263; D496,906; D505,114; D506,438; D509,472; and for use under 6,975,098 and 6,984,965

Vicor Corporation

25 Frontage Road
Andover, MA, USA 01810
Tel: 800-735-6200
Fax: 978-475-6715

email

Customer Service: custserv@vicorpower.com
Technical Support: apps@vicorpower.com