



Chipsmall Limited consists of a professional team with an average of over 10 year of expertise in the distribution of electronic components. Based in Hongkong, we have already established firm and mutual-benefit business relationships with customers from,Europe,America and south Asia,supplying obsolete and hard-to-find components to meet their specific needs.

With the principle of “Quality Parts,Customers Priority,Honest Operation,and Considerate Service”,our business mainly focus on the distribution of electronic components. Line cards we deal with include Microchip,ALPS,ROHM,Xilinx,Pulse,ON,Everlight and Freescale. Main products comprise IC,Modules,Potentiometer,IC Socket,Relay,Connector.Our parts cover such applications as commercial,industrial, and automotives areas.

We are looking forward to setting up business relationship with you and hope to provide you with the best service and solution. Let us make a better world for our industry!



## Contact us

Tel: +86-755-8981 8866 Fax: +86-755-8427 6832

Email & Skype: info@chipsmall.com Web: www.chipsmall.com

Address: A1208, Overseas Decoration Building, #122 Zhenhua RD., Futian, Shenzhen, China



# RF LDMOS Wideband Integrated Power Amplifiers

The MWE6IC9100N wideband integrated circuit is designed with on-chip matching that makes it usable from 869 to 960 MHz. This multi-stage structure is rated for 26 to 32 Volt operation and covers all typical cellular base station modulations.

## Final Application

- Typical GSM Performance:  $V_{DD} = 26$  Volts,  $I_{DQ1} = 120$  mA,  $I_{DQ2} = 950$  mA,  $P_{out} = 100$  Watts CW,  $f = 960$  MHz  
Power Gain — 33.5 dB  
Power Added Efficiency — 54%

## GSM EDGE Application

- Typical GSM EDGE Performance:  $V_{DD} = 28$  Volts,  $I_{DQ1} = 230$  mA,  $I_{DQ2} = 870$  mA,  $P_{out} = 50$  Watts Avg., Full Frequency Band (869–960 MHz)  
Power Gain — 35.5 dB  
Power Added Efficiency — 39%  
Spectral Regrowth @ 400 kHz Offset = -63 dBc  
Spectral Regrowth @ 600 kHz Offset = -81 dBc  
EVM — 2% rms
- Capable of Handling 10:1 VSWR, @ 32 Vdc, 960 MHz, 3 dB Overdrive, Designed for Enhanced Ruggedness
- Stable into a 5:1 VSWR. All Spurs Below -60 dBc @ 1 mW to 120 W CW  $P_{out}$ .

## Features

- Characterized with Series Equivalent Large-Signal Impedance Parameters and Common Source S-Parameters
- On-Chip Matching (50 Ohm Input, DC Blocked)
- Integrated Quiescent Current Temperature Compensation with Enable/Disable Function (1)
- Integrated ESD Protection
- 225°C Capable Plastic Package
- RoHS Compliant
- In Tape and Reel. R1 Suffix = 500 Units per 44 mm, 13 inch Reel.

**MWE6IC9100NR1**  
**MWE6IC9100GNR1**  
**MWE6IC9100NBR1**

**960 MHz, 100 W, 26 V**  
**GSM/GSM EDGE**  
**RF LDMOS WIDEBAND**  
**INTEGRATED POWER AMPLIFIERS**

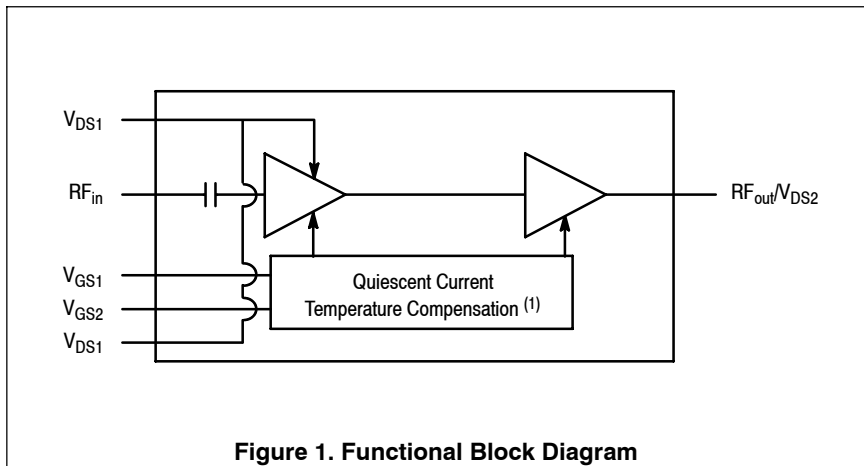
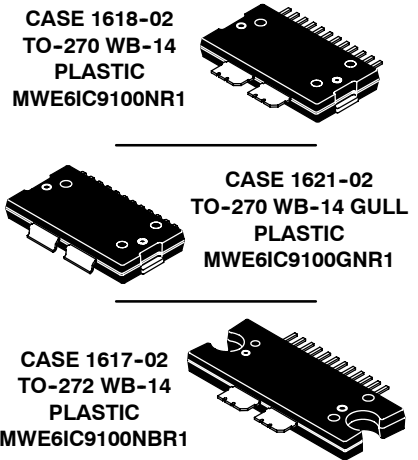


Figure 1. Functional Block Diagram

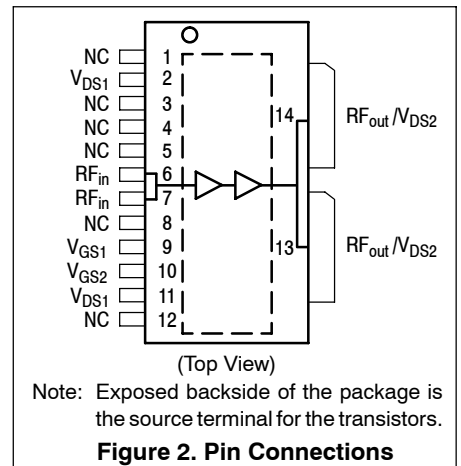


Figure 2. Pin Connections

1. Refer to AN1977, *Quiescent Current Thermal Tracking Circuit in the RF Integrated Circuit Family* and to AN1987, *Quiescent Current Control for the RF Integrated Circuit Device Family*. Go to <http://www.freescale.com/rf>. Select Documentation/Application Notes - AN1977 or AN1987.

ARCHIVE INFORMATION

ARCHIVE INFORMATION

**Table 1. Maximum Ratings**

| Rating                               | Symbol    | Value       | Unit |
|--------------------------------------|-----------|-------------|------|
| Drain-Source Voltage                 | $V_{DSS}$ | -0.5, +66   | Vdc  |
| Gate-Source Voltage                  | $V_{GS}$  | -0.5, +6    | Vdc  |
| Storage Temperature Range            | $T_{stg}$ | -65 to +150 | °C   |
| Case Operating Temperature           | $T_C$     | 150         | °C   |
| Operating Junction Temperature (1,2) | $T_J$     | 225         | °C   |

**Table 2. Thermal Characteristics**

| Characteristic                                   | Symbol   | Value (2,3)  | Unit |
|--|--|--------------|------|
| Thermal Resistance, Junction to Case             | $R_{\theta JC}$  |              | °C/W |
| GSM Application<br>( $P_{out} = 100$ W CW)       | Stage 1, 26 Vdc, $I_{DQ1} = 120$ mA<br>Stage 2, 26 Vdc, $I_{DQ2} = 950$ mA | 1.82<br>0.38 |      |
| GSM EDGE Application<br>( $P_{out} = 50$ W Avg.) | Stage 1, 28 Vdc, $I_{DQ1} = 230$ mA<br>Stage 2, 28 Vdc, $I_{DQ2} = 870$ mA | 1.77<br>0.44 |      |

**Table 3. ESD Protection Characteristics**

| Test Methodology                      | Class         |
|---------------------------------------|---------------|
| Human Body Model (per JESD22-A114)    | 2 (Minimum)   |
| Machine Model (per EIA/JESD22-A115)   | B (Minimum)   |
| Charge Device Model (per JESD22-C101) | III (Minimum) |

**Table 4. Moisture Sensitivity Level**

| Test Methodology                      | Rating | Package Peak Temperature | Unit |
|---------------------------------------|--------|--------------------------|------|
| Per JESD 22-A113, IPC/JEDEC J-STD-020 | 3      | 260                      | °C   |

**Table 5. Electrical Characteristics** ( $T_C = 25^\circ\text{C}$  unless otherwise noted)

| Characteristic  | Symbol       | Min | Typ | Max | Unit            |
|---|--------------|-----|-----|-----|-----------------|
| <b>Stage 1 — Off Characteristics</b>  |              |     |     |     |                 |
| Zero Gate Voltage Drain Leakage Current<br>( $V_{DS} = 66$ Vdc, $V_{GS} = 0$ Vdc)                     | $I_{DSS}$    | —   | —   | 10  | $\mu\text{Adc}$ |
| Zero Gate Voltage Drain Leakage Current<br>( $V_{DS} = 28$ Vdc, $V_{GS} = 0$ Vdc)                     | $I_{DSS}$    | —   | —   | 1   | $\mu\text{Adc}$ |
| Gate-Source Leakage Current<br>( $V_{GS} = 5$ Vdc, $V_{DS} = 0$ Vdc)                                  | $I_{GSS}$    | —   | —   | 10  | $\mu\text{Adc}$ |
| <b>Stage 1 — On Characteristics</b>   |              |     |     |     |                 |
| Gate Threshold Voltage<br>( $V_{DS} = 10$ Vdc, $I_D = 35$ $\mu\text{Adc}$ )                           | $V_{GS(th)}$ | 1.5 | 2   | 3.5 | Vdc             |
| Gate Quiescent Voltage<br>( $V_{DS} = 26$ Vdc, $I_D = 120$ mAdc)                                      | $V_{GS(Q)}$  | —   | 2.7 | —   | Vdc             |
| Fixture Gate Quiescent Voltage<br>( $V_{DD} = 26$ Vdc, $I_D = 120$ mAdc, Measured in Functional Test) | $V_{GG(Q)}$  | 6   | 9.4 | 12  | Vdc             |

1. Continuous use at maximum temperature will affect MTTF.
2. MTTF calculator available at <http://www.freescale.com/rf>. Select Software & Tools/Development Tools/Calculators to access MTTF calculators by product.
3. Refer to AN1955, *Thermal Measurement Methodology of RF Power Amplifiers*. Go to <http://www.freescale.com/rf>. Select Documentation/Application Notes - AN1955.

(continued)



**Table 5. Electrical Characteristics** ( $T_C = 25^\circ\text{C}$  unless otherwise noted) (continued)

| Characteristic  | Symbol    | Min | Typ | Max | Unit            |
|---|-----------|-----|-----|-----|-----------------|
| <b>Stage 2 — Off Characteristics</b>  |           |     |     |     |                 |
| Zero Gate Voltage Drain Leakage Current<br>( $V_{DS} = 66\text{ Vdc}$ , $V_{GS} = 0\text{ Vdc}$ ) | $I_{DSS}$ | —   | —   | 10  | $\mu\text{Adc}$ |
| Zero Gate Voltage Drain Leakage Current<br>( $V_{DS} = 28\text{ Vdc}$ , $V_{GS} = 0\text{ Vdc}$ ) | $I_{DSS}$ | —   | —   | 1   | $\mu\text{Adc}$ |
| Gate-Source Leakage Current<br>( $V_{GS} = 5\text{ Vdc}$ , $V_{DS} = 0\text{ Vdc}$ )              | $I_{GSS}$ | —   | —   | 10  | $\mu\text{Adc}$ |

**Stage 2 — On Characteristics**

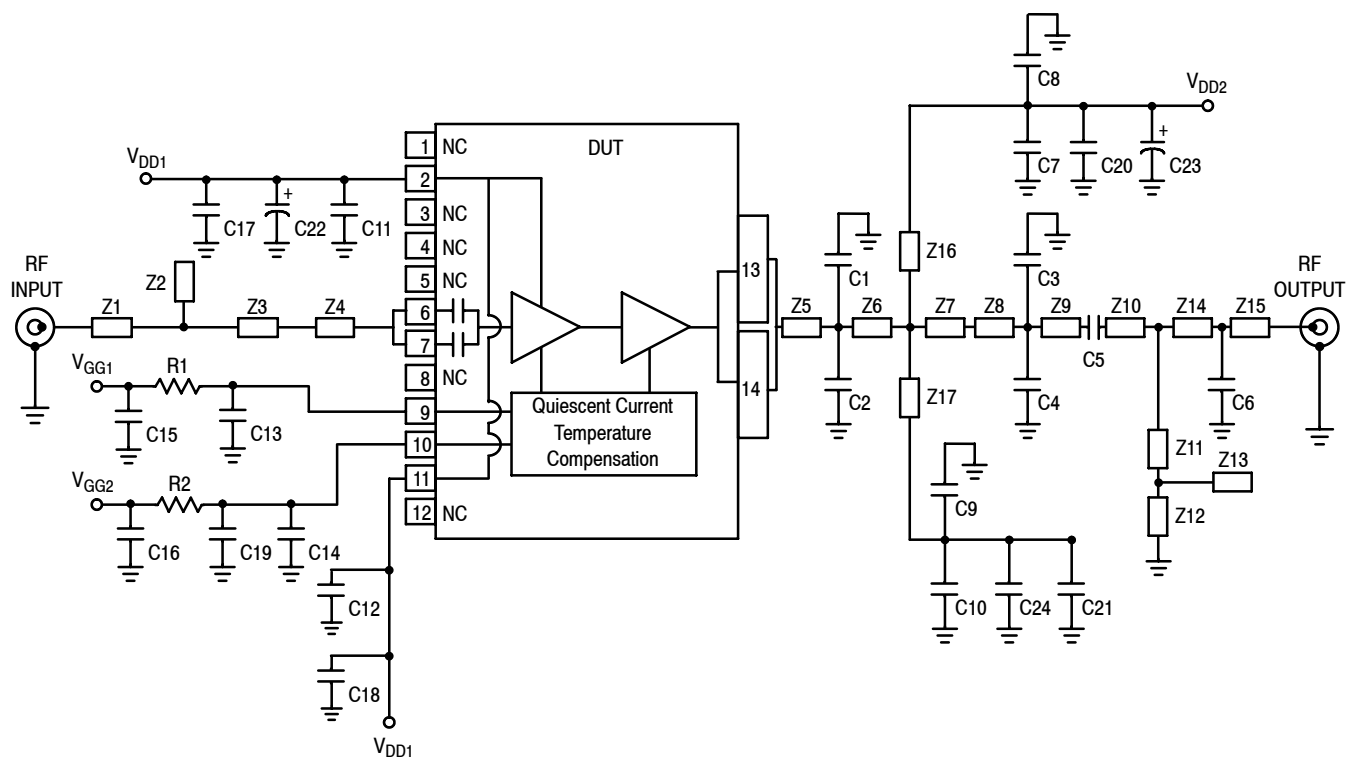
|   |              |      |     |     |     |
|---|--------------|------|-----|-----|-----|
| Gate Threshold Voltage<br>( $V_{DS} = 10\text{ Vdc}$ , $I_D = 290\ \mu\text{Adc}$ )                                   | $V_{GS(th)}$ | 1.5  | 2   | 3.5 | Vdc |
| Gate Quiescent Voltage<br>( $V_{DS} = 26\text{ Vdc}$ , $I_D = 950\text{ mAdc}$ )                                      | $V_{GS(Q)}$  | —    | 2.7 | —   | Vdc |
| Fixture Gate Quiescent Voltage<br>( $V_{DD} = 26\text{ Vdc}$ , $I_D = 950\text{ mAdc}$ , Measured in Functional Test) | $V_{GG(Q)}$  | 6    | 8.6 | 12  | Vdc |
| Drain-Source On-Voltage<br>( $V_{GS} = 10\text{ Vdc}$ , $I_D = 1\text{ Adc}$ )  | $V_{DS(on)}$ | 0.05 | 0.4 | 0.8 | Vdc |

**Functional Tests** (In Freescale Test Fixture, 50 ohm system)  $V_{DD} = 26\text{ Vdc}$ ,  $P_{out} = 100\text{ W CW}$ ,  $I_{DQ1} = 120\text{ mA}$ ,  $I_{DQ2} = 950\text{ mA}$ ,  $f = 960\text{ MHz}$ 

|  |          |     |      |     |    |
|--|----------|-----|------|-----|----|
| Power Gain                             | $G_{ps}$ | 31  | 33.5 | 36  | dB |
| Input Return Loss                      | IRL      | —   | -15  | -10 | dB |
| Power Added Efficiency                 | PAE      | 52  | 54   | —   | %  |
| $P_{out}$ @ 1 dB Compression Point, CW | P1dB     | 100 | 112  | —   | W  |

**Typical GSM EDGE Performances** (In Freescale GSM EDGE Test Fixture, 50 ohm system)  $V_{DD} = 28\text{ Vdc}$ ,  $P_{out} = 50\text{ W Avg.}$ ,  $I_{DQ1} = 230\text{ mA}$ ,  $I_{DQ2} = 870\text{ mA}$ , 869-894 MHz and 920-960 MHz EDGE Modulation

|                                     |          |   |      |   |       |
|-------------------------------------|----------|---|------|---|-------|
| Power Gain                          | $G_{ps}$ | — | 35.5 | — | dB    |
| Power Added Efficiency              | PAE      | — | 39   | — | %     |
| Error Vector Magnitude              | EVM      | — | 2    | — | % rms |
| Spectral Regrowth at 400 kHz Offset | SR1      | — | -63  | — | dBc   |
| Spectral Regrowth at 600 kHz Offset | SR2      | — | -81  | — | dBc   |

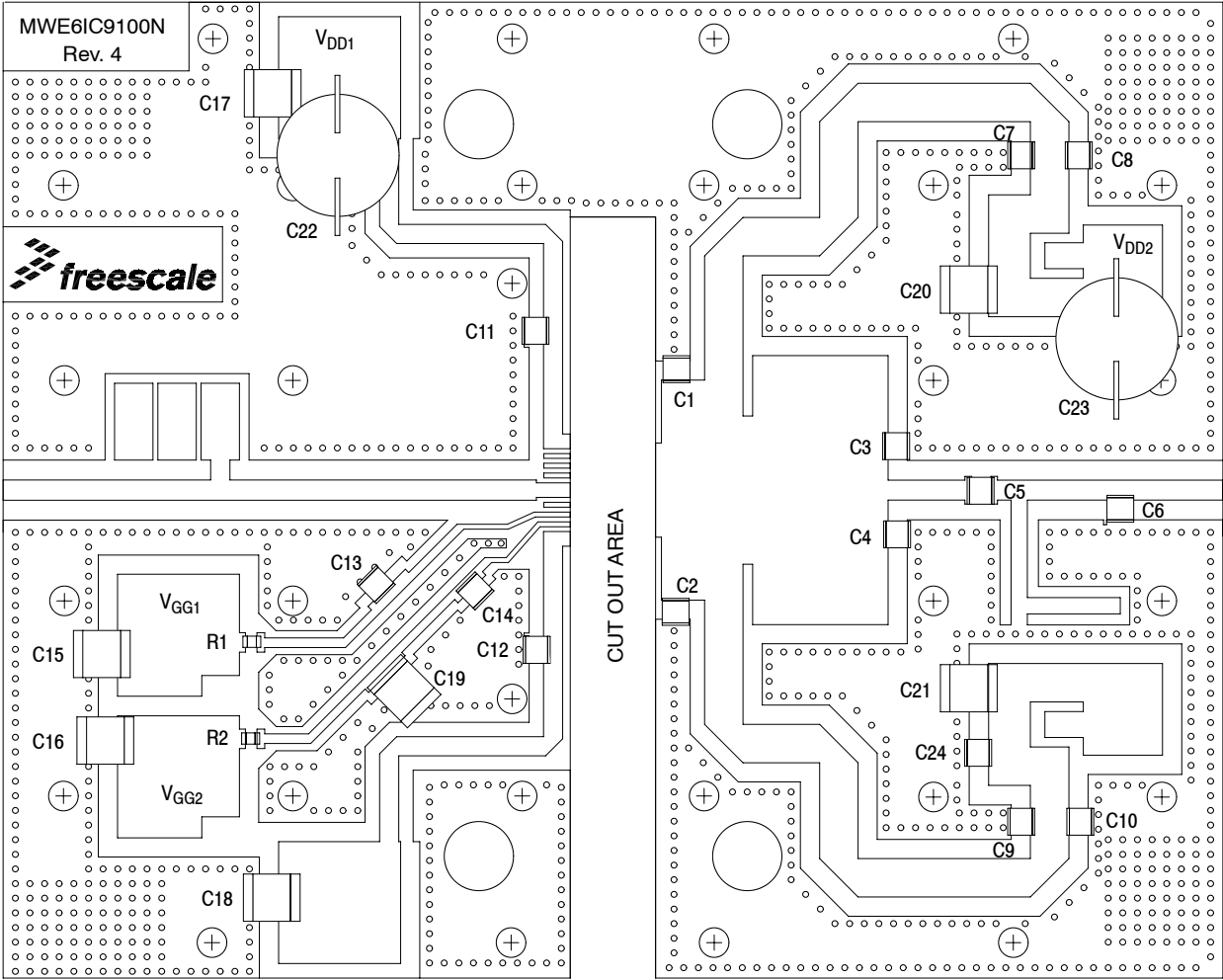


|    |                            |          |  |
|----|----------------------------|----------|--|
| Z1 | 0.089" x 0.083" Microstrip | Z10      | 0.117" x 0.083" Microstrip                     |
| Z2 | 0.157" x 0.315" Microstrip | Z11      | 0.067" x 0.431" Microstrip                     |
| Z3 | 0.157" x 0.397" Microstrip | Z12      | 0.067" x 0.084" Microstrip                     |
| Z4 | 0.139" x 0.060" Microstrip | Z13      | 0.381" x 0.067" Microstrip                     |
| Z5 | 0.024" x 0.386" Microstrip | Z14      | 0.418" x 0.084" Microstrip                     |
| Z6 | 0.352" x 0.902" Microstrip | Z15      | 0.421" x 0.084" Microstrip                     |
| Z7 | 0.039" x 0.607" Microstrip | Z16, Z17 | 2.550" x 0.157" Microstrip                     |
| Z8 | 0.555" x 1.102" Microstrip | PCB      | Taconic TLX8-0300, 0.030", $\epsilon_r = 2.55$ |
| Z9 | 0.343" x 0.083" Microstrip |          |  |

**Figure 3. MWE6IC9100NR1(GNR1)(NBR1) Test Circuit Schematic**

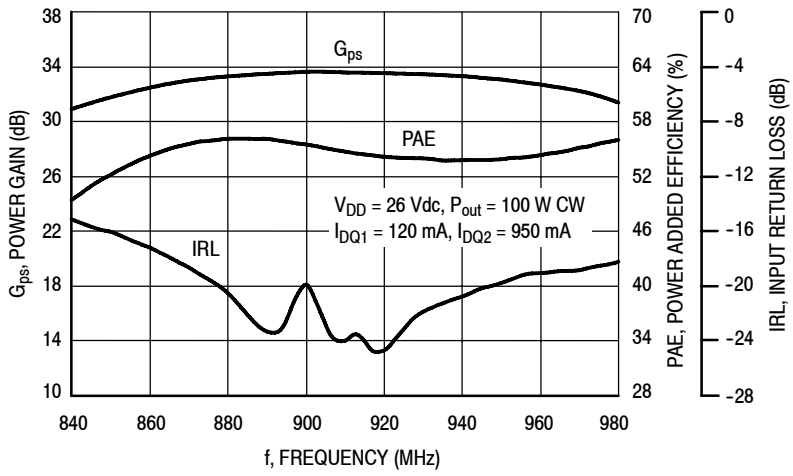
**Table 6. MWE6IC9100NR1(GNR1)(NBR1) Test Circuit Component Designations and Values**

| Part                                | Description                                       | Part Number       | Manufacturer |
|-------------------------------------|---|-------------------|--------------|
| C1, C2                              | 10 pF Chip Capacitors                             | ATC100B100GT500XT | ATC          |
| C3, C4, C5                          | 3.9 pF Chip Capacitors                            | ATC100B3R9BT500XT | ATC          |
| C6                                  | 0.5 pF Chip Capacitor                             | ATC100B0R5BT500XT | ATC          |
| C7, C8, C9, C10, C11, C12, C13, C14 | 33 pF Chip Capacitors                             | ATC100B330JT500XT | ATC          |
| C15, C16, C17, C18, C19, C20, C21   | 6.8 $\mu$ F Chip Capacitors                       | C4532X5R1H685MT   | TDK          |
| C22, C23                            | 470 $\mu$ F, 63 V Electrolytic Capacitors, Radial | 222212018470      | Vishay       |
| C24                                 | 330 pF Chip Capacitor                             | ATC100B331JT200XT | ATC          |
| R1, R2                              | 4.7 k $\Omega$ , 1/8 W Chip Resistors             | CRCW08054701FKEA  | Vishay       |

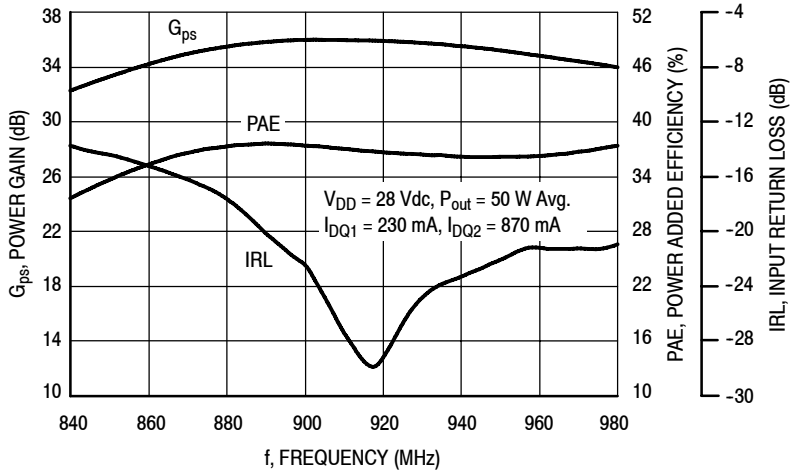


**Figure 4. MWE6IC9100NR1(GNR1)(NBR1) Test Circuit Component Layout**

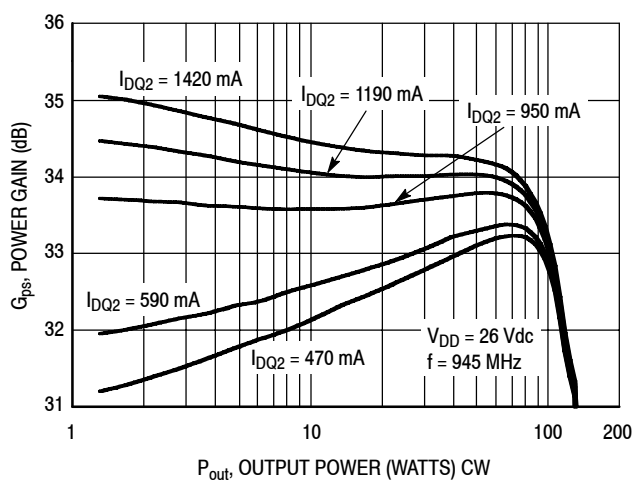
### TYPICAL CHARACTERISTICS



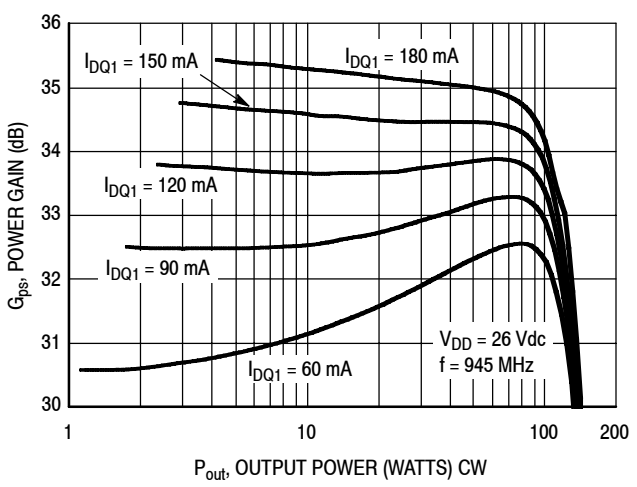
**Figure 5. Power Gain, Input Return Loss and Power Added Efficiency versus Frequency @  $P_{out} = 100$  Watts CW**



**Figure 6. Power Gain, Input Return Loss and Power Added Efficiency versus Frequency @  $P_{out} = 50$  Watts Avg.**



**Figure 7. Power Gain versus Output Power @  $I_{DQ1} = 120$  mA**

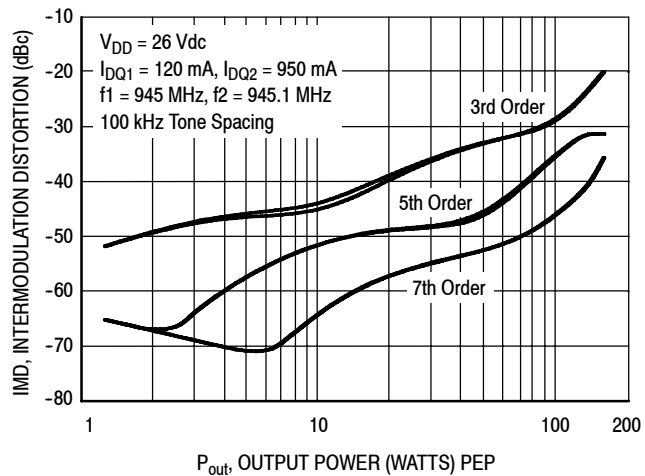


**Figure 8. Power Gain versus Output Power @  $I_{DQ2} = 950$  mA**

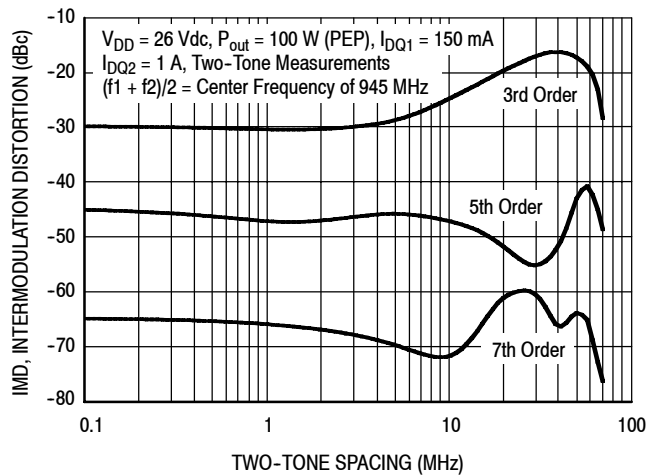
ARCHIVE INFORMATION

ARCHIVE INFORMATION

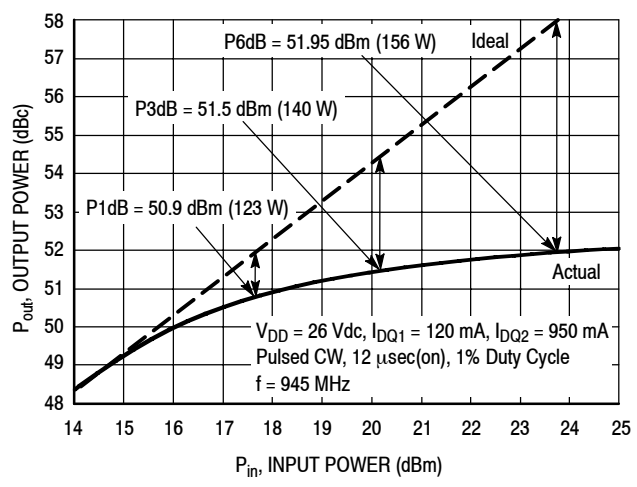
### TYPICAL CHARACTERISTICS



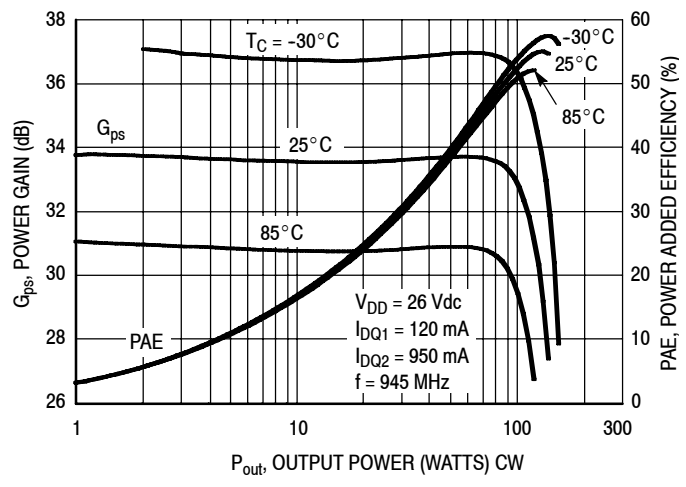
**Figure 9. Intermodulation Distortion Products versus Output Power**



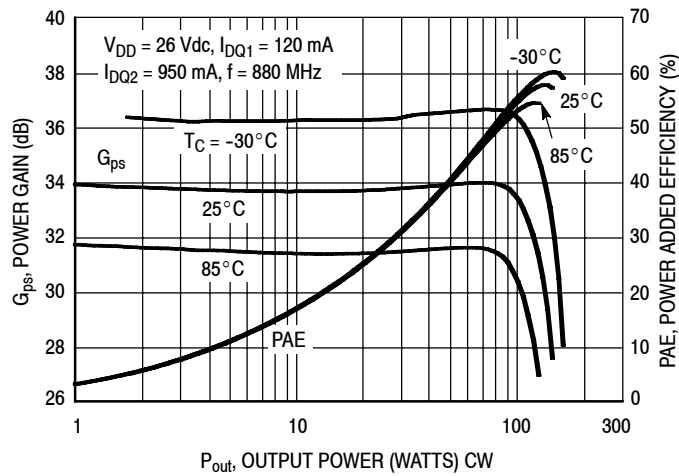
**Figure 10. Intermodulation Distortion Products versus Tone Spacing**



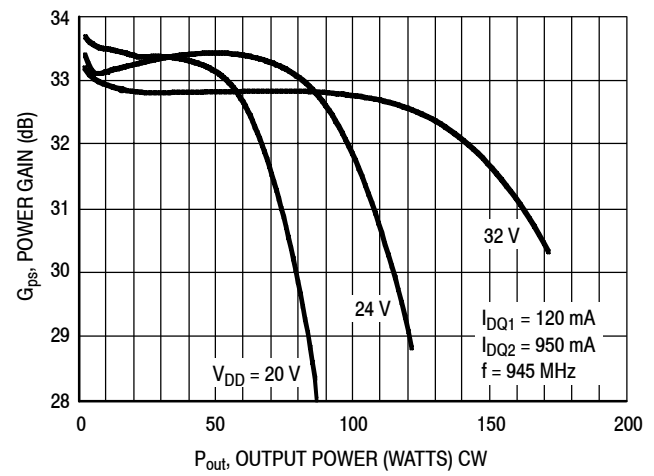
**Figure 11. Pulsed CW Output Power versus Input Power**



**Figure 12. Power Gain and Power Added Efficiency versus Output Power @ 945 MHz**



**Figure 13. Power Gain and Power Added Efficiency versus Output Power @ 880 MHz**



**Figure 14. Power Gain versus Output Power**

ARCHIVE INFORMATION

ARCHIVE INFORMATION



## TYPICAL CHARACTERISTICS

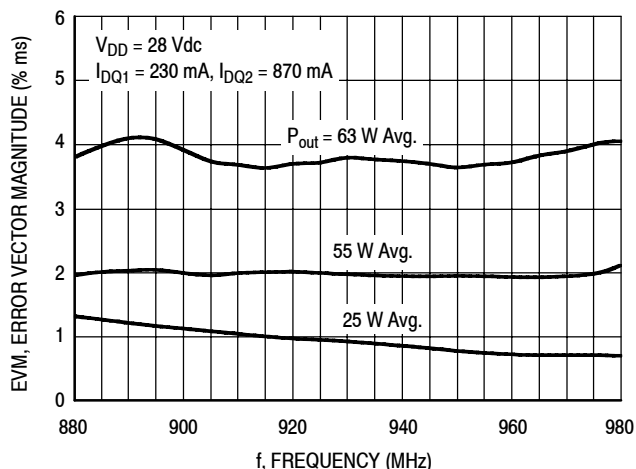


Figure 15. EVM versus Frequency

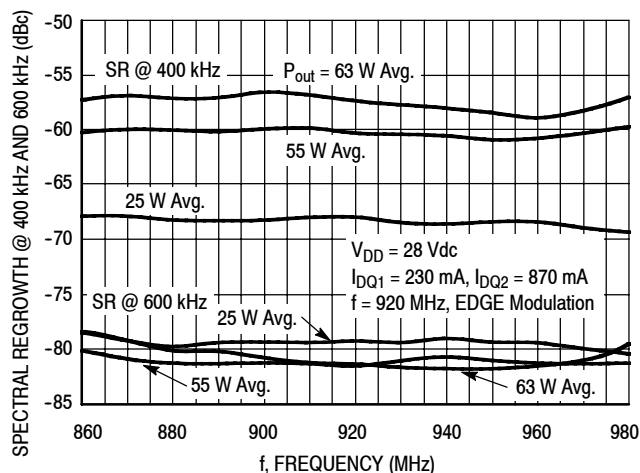


Figure 16. Spectral Regrowth at 400 kHz and 600 kHz versus Frequency

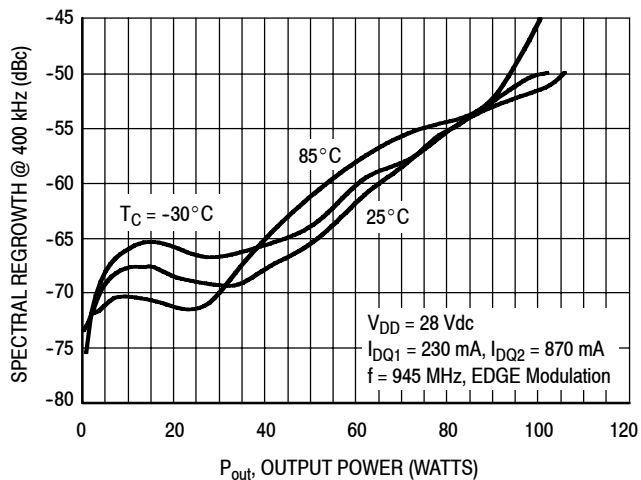


Figure 17. Spectral Regrowth at 400 kHz versus Output Power @ 945 MHz

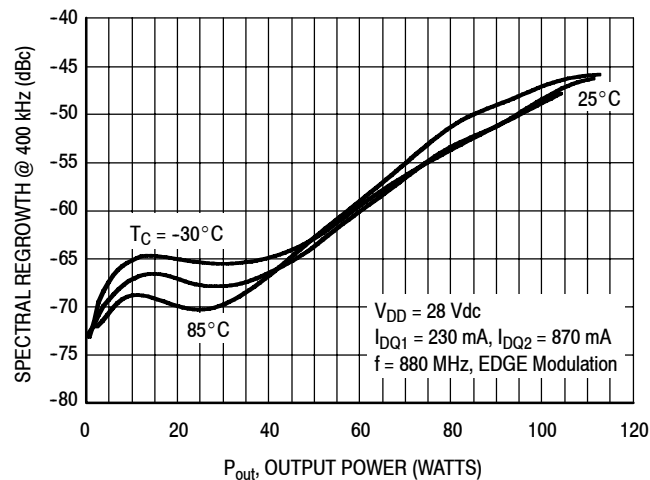


Figure 18. Spectral Regrowth at 400 kHz versus Output Power @ 880 MHz

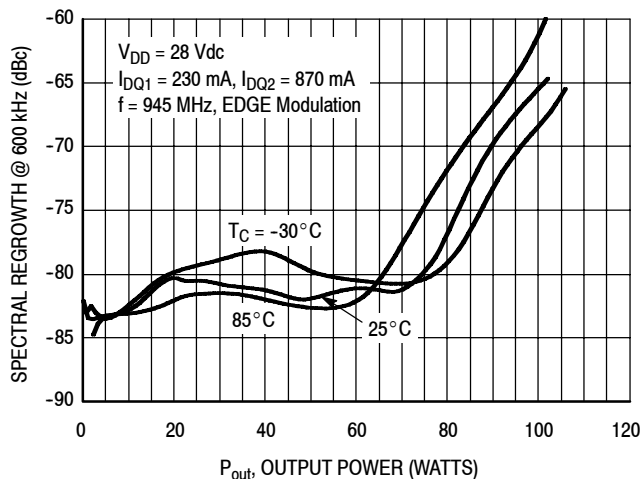


Figure 19. Spectral Regrowth at 600 kHz versus Output Power @ 945 MHz

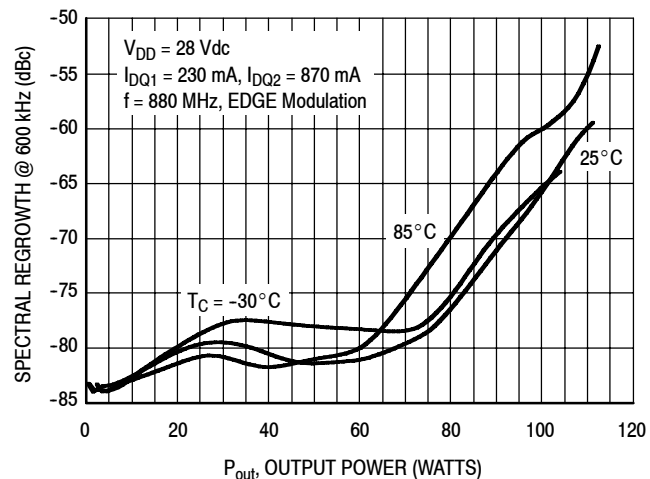
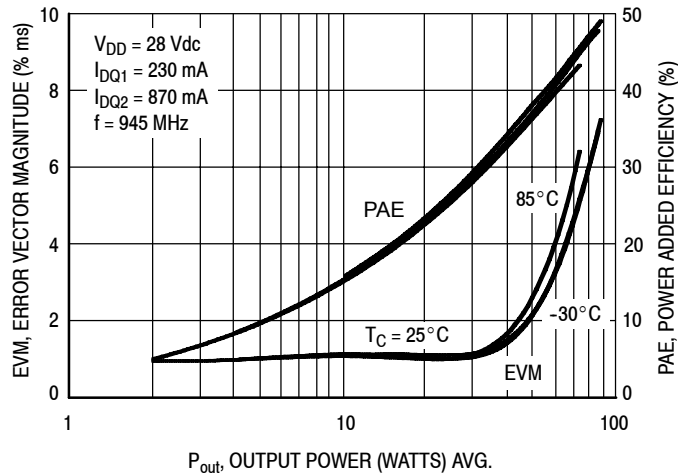
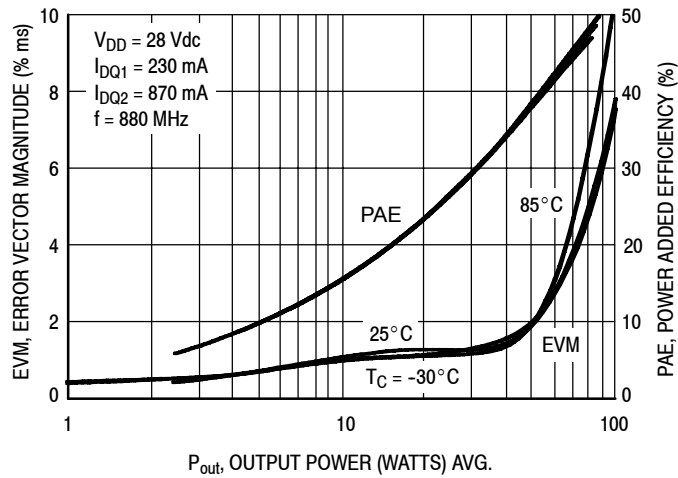


Figure 20. Spectral Regrowth at 600 kHz versus Output Power @ 880 MHz

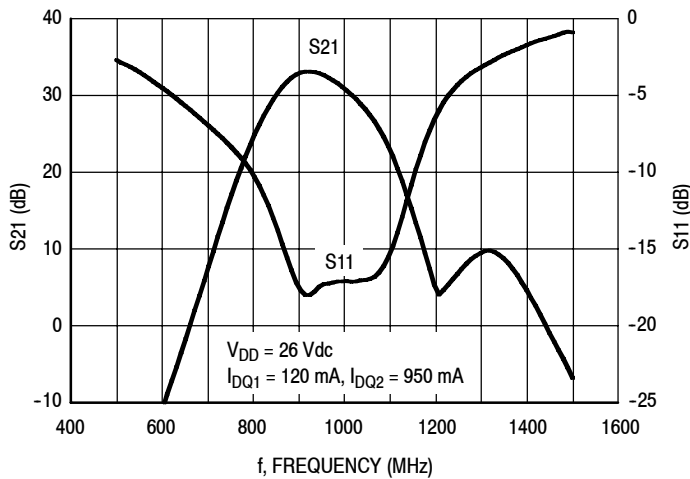
### TYPICAL CHARACTERISTICS



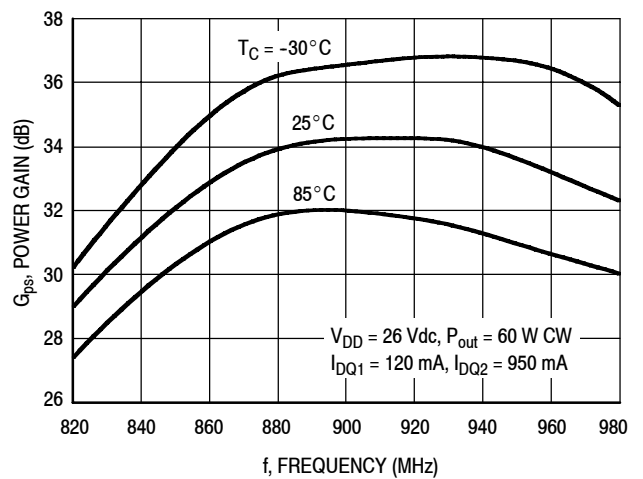
**Figure 21. EVM and Power Added Efficiency versus Output Power @ 945 MHz**



**Figure 22. EVM and Power Added Efficiency versus Output Power @ 880 MHz**



**Figure 23. Broadband Frequency Response**

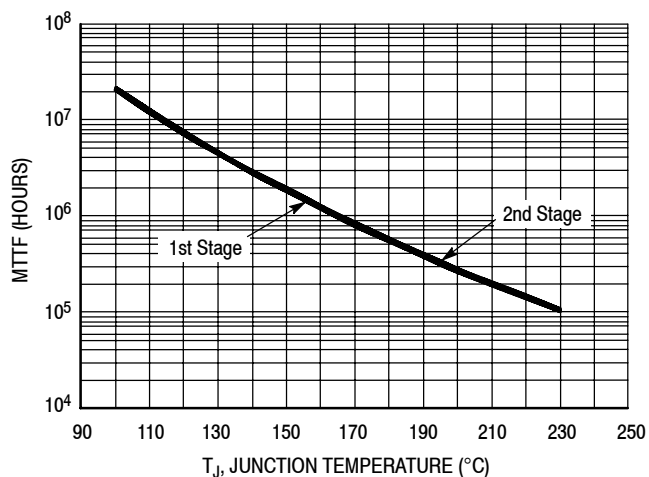


**Figure 24. Power Gain versus Frequency**

ARCHIVE INFORMATION

ARCHIVE INFORMATION

### TYPICAL CHARACTERISTICS

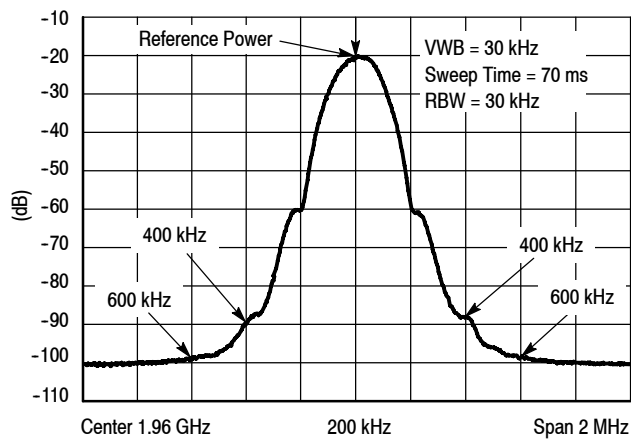


This above graph displays calculated MTTF in hours when the device is operated at  $V_{DD} = 26$  Vdc,  $P_{out} = 100$  W CW, and PAE = 54%.

MTTF calculator available at <http://www.freescale.com/rf>. Select Software & Tools/Development Tools/Calculators to access MTTF calculators by product.

**Figure 25. MTTF versus Junction Temperature**

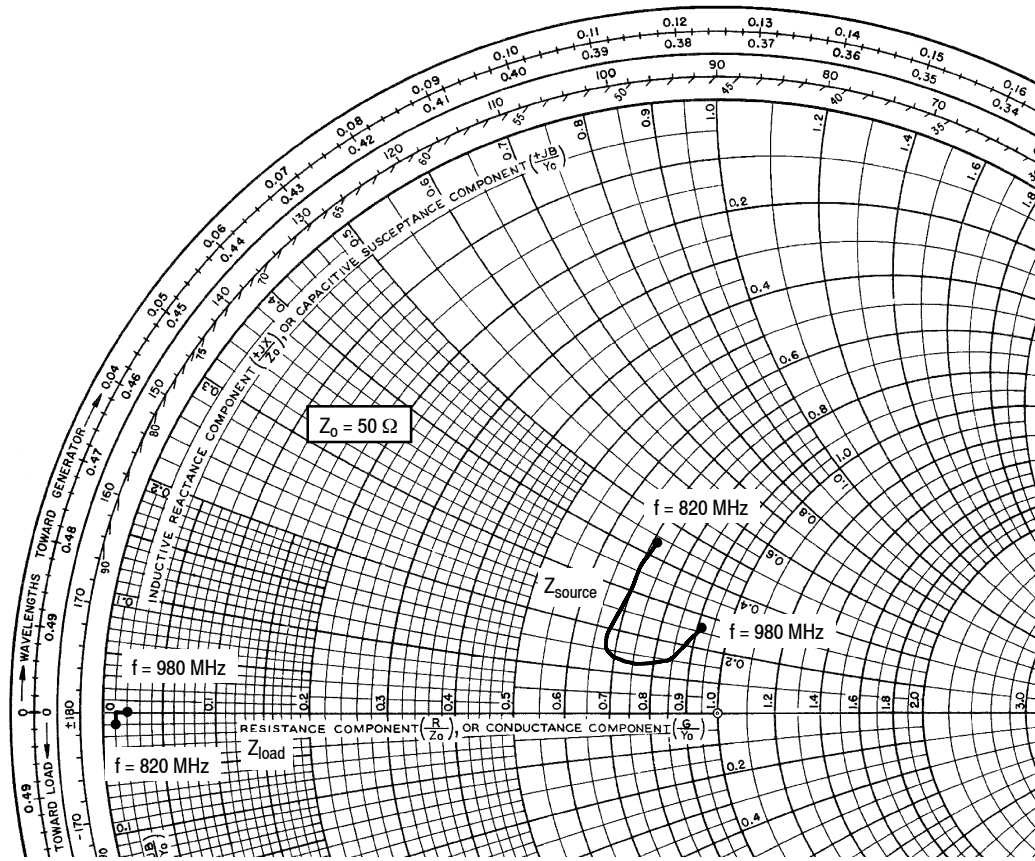
### GSM TEST SIGNAL



**Figure 26. EDGE Spectrum**

ARCHIVE INFORMATION

ARCHIVE INFORMATION



$V_{DD} = 26 \text{ Vdc}$ ,  $I_{DQ1} = 120 \text{ mA}$ ,  $I_{DQ2} = 950 \text{ mA}$ ,  $P_{out} = 100 \text{ W CW}$

| f<br>MHz | $Z_{source}$<br>$\Omega$ | $Z_{load}$<br>$\Omega$ |
|----------|--------------------------|------------------------|
| 820      | $35.40 + j21.50$         | $0.516 - j0.365$       |
| 840      | $35.00 + j18.00$         | $0.638 - j0.172$       |
| 860      | $35.00 + j15.50$         | $0.768 - j0.010$       |
| 880      | $34.50 + j12.20$         | $0.874 + j0.071$       |
| 900      | $34.00 + j9.00$          | $1.030 + j0.133$       |
| 920      | $34.30 + j7.20$          | $1.101 + j0.082$       |
| 940      | $38.50 + j6.00$          | $1.088 + j0.037$       |
| 960      | $42.00 + j7.40$          | $1.011 + j0.018$       |
| 980      | $45.55 + j12.75$         | $0.872 + j0.051$       |

$Z_{source}$  = Test circuit impedance as measured from gate to ground.

$Z_{load}$  = Test circuit impedance as measured from drain to ground.

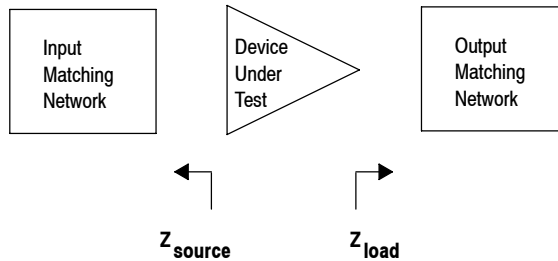


Figure 27. Series Equivalent Source and Load Impedance

**Table 7. Common Source Scattering Parameters** ( $V_{DD} = 26\text{ V}$ , 50 ohm system,  $I_{DQ1} = 120\text{ mA}$ ,  $I_{DQ2} = 950\text{ mA}$ )

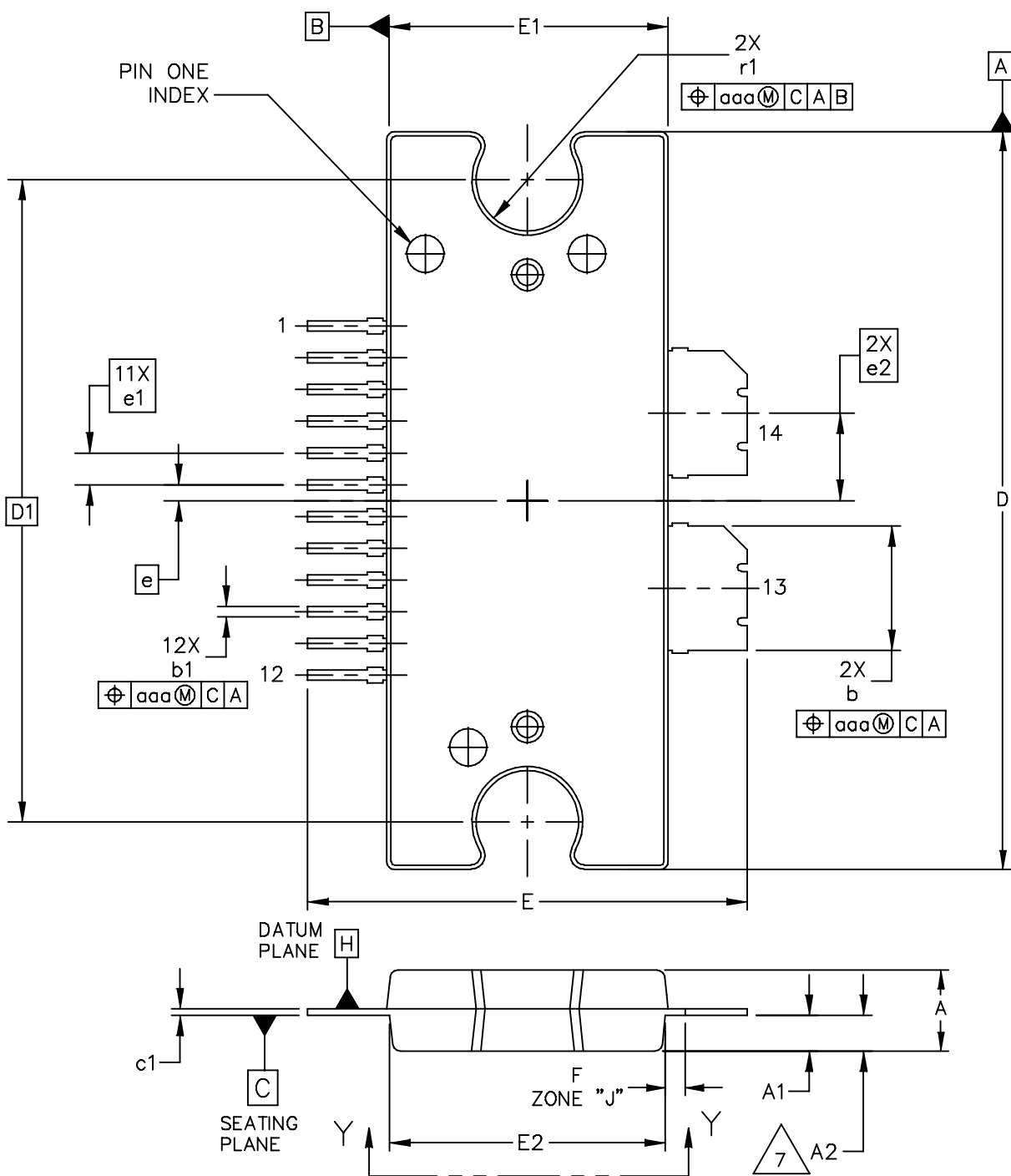
| f<br>MHz | S <sub>11</sub> |      | S <sub>21</sub> |      | S <sub>12</sub> |      | S <sub>22</sub> |      |
|----------|-----------------|------|-----------------|------|-----------------|------|-----------------|------|
|          | S <sub>11</sub> | ∠ φ  | S <sub>21</sub> | ∠ φ  | S <sub>12</sub> | ∠ φ  | S <sub>22</sub> | ∠ φ  |
| 750      | 0.230           | 95   | 5.81            | -87  | 0.0007          | -119 | 0.989           | -180 |
| 760      | 0.188           | 93   | 6.48            | -97  | 0.0007          | -116 | 0.987           | 180  |
| 770      | 0.149           | 92   | 7.18            | -107 | 0.0007          | -111 | 0.985           | 180  |
| 780      | 0.114           | 92   | 7.88            | -117 | 0.0007          | -110 | 0.983           | 180  |
| 790      | 0.085           | 96   | 8.56            | -128 | 0.0008          | -109 | 0.981           | 180  |
| 800      | 0.063           | 104  | 9.22            | -139 | 0.0008          | -108 | 0.979           | 180  |
| 810      | 0.047           | 117  | 9.82            | -150 | 0.0009          | -109 | 0.978           | 180  |
| 820      | 0.037           | 134  | 10.37           | -161 | 0.0009          | -110 | 0.978           | -180 |
| 830      | 0.031           | 156  | 10.85           | -172 | 0.0009          | -111 | 0.977           | -180 |
| 840      | 0.029           | -177 | 11.27           | 178  | 0.0010          | -113 | 0.977           | -180 |
| 850      | 0.033           | -152 | 11.60           | 167  | 0.0010          | -114 | 0.978           | -180 |
| 860      | 0.041           | -134 | 11.87           | 156  | 0.0010          | -117 | 0.978           | -180 |
| 870      | 0.052           | -123 | 12.07           | 146  | 0.0010          | -119 | 0.979           | -180 |
| 880      | 0.063           | -116 | 12.20           | 135  | 0.0010          | -122 | 0.979           | -180 |
| 890      | 0.074           | -112 | 12.25           | 125  | 0.0010          | -123 | 0.979           | 180  |
| 900      | 0.084           | -109 | 12.23           | 115  | 0.0010          | -126 | 0.980           | 180  |
| 910      | 0.094           | -106 | 12.15           | 106  | 0.0010          | -129 | 0.979           | 180  |
| 920      | 0.104           | -103 | 12.01           | 96   | 0.0010          | -131 | 0.978           | 180  |
| 930      | 0.113           | -99  | 11.82           | 86   | 0.0009          | -133 | 0.978           | 180  |
| 940      | 0.125           | -95  | 11.57           | 77   | 0.0009          | -135 | 0.977           | 180  |
| 950      | 0.141           | -91  | 11.28           | 68   | 0.0008          | -138 | 0.976           | 180  |
| 960      | 0.160           | -88  | 10.97           | 59   | 0.0008          | -136 | 0.976           | 180  |
| 970      | 0.183           | -86  | 10.62           | 50   | 0.0007          | -135 | 0.976           | 180  |
| 980      | 0.209           | -85  | 10.23           | 42   | 0.0006          | -133 | 0.976           | 180  |
| 990      | 0.238           | -85  | 9.83            | 34   | 0.0006          | -130 | 0.975           | 180  |
| 1000     | 0.268           | -86  | 9.41            | 26   | 0.0006          | -125 | 0.975           | 180  |

ARCHIVE INFORMATION

ARCHIVE INFORMATION



PACKAGE DIMENSIONS

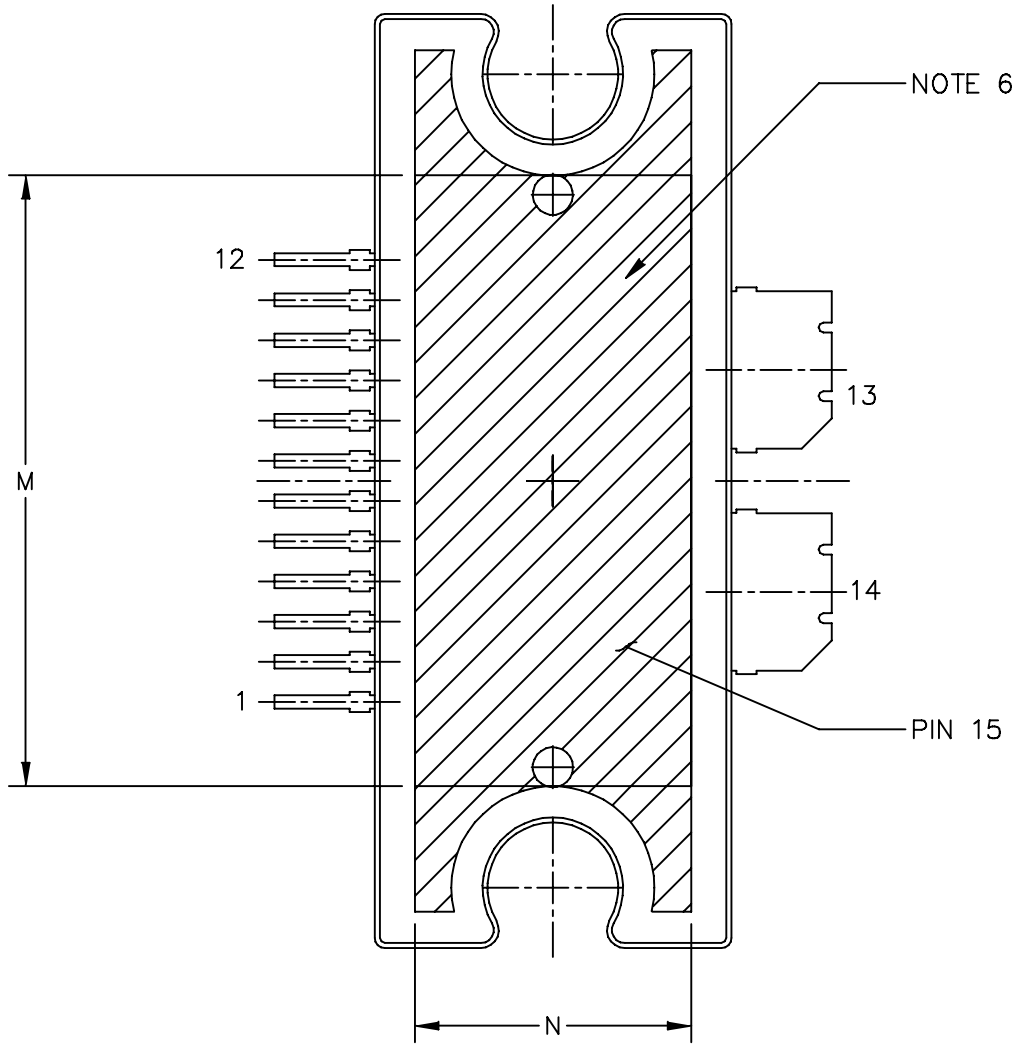


ARCHIVE INFORMATION

ARCHIVE INFORMATION

|   |                          |                            |             |
|---|--------------------------|----------------------------|-------------|
| © FREESCALE SEMICONDUCTOR, INC.<br>ALL RIGHTS RESERVED. | MECHANICAL OUTLINE       | PRINT VERSION NOT TO SCALE |             |
| TITLE:<br>TO-272 WIDE BODY<br>14 LEAD                   | DOCUMENT NO: 98ASA10649D |                            | REV: A      |
|   | CASE NUMBER: 1617-02     |                            | 27 JUN 2007 |
|   | STANDARD: NON-JEDEC      |                            |             |

MWE6IC9100NR1 MWE6IC9100GNR1 MWE6IC9100NBR1



VIEW Y-Y

|   |                          |                    |                            |
|---|--------------------------|--------------------|----------------------------|
| © FREESCALE SEMICONDUCTOR, INC.<br>ALL RIGHTS RESERVED. |                          | MECHANICAL OUTLINE | PRINT VERSION NOT TO SCALE |
| TITLE:<br>TO-272 WIDE BODY<br>14 LEAD                   | DOCUMENT NO: 98ASA10649D |                    | REV: A                     |
|   | CASE NUMBER: 1617-02     |                    | 27 JUN 2007                |
|   | STANDARD: NON-JEDEC      |                    |                            |

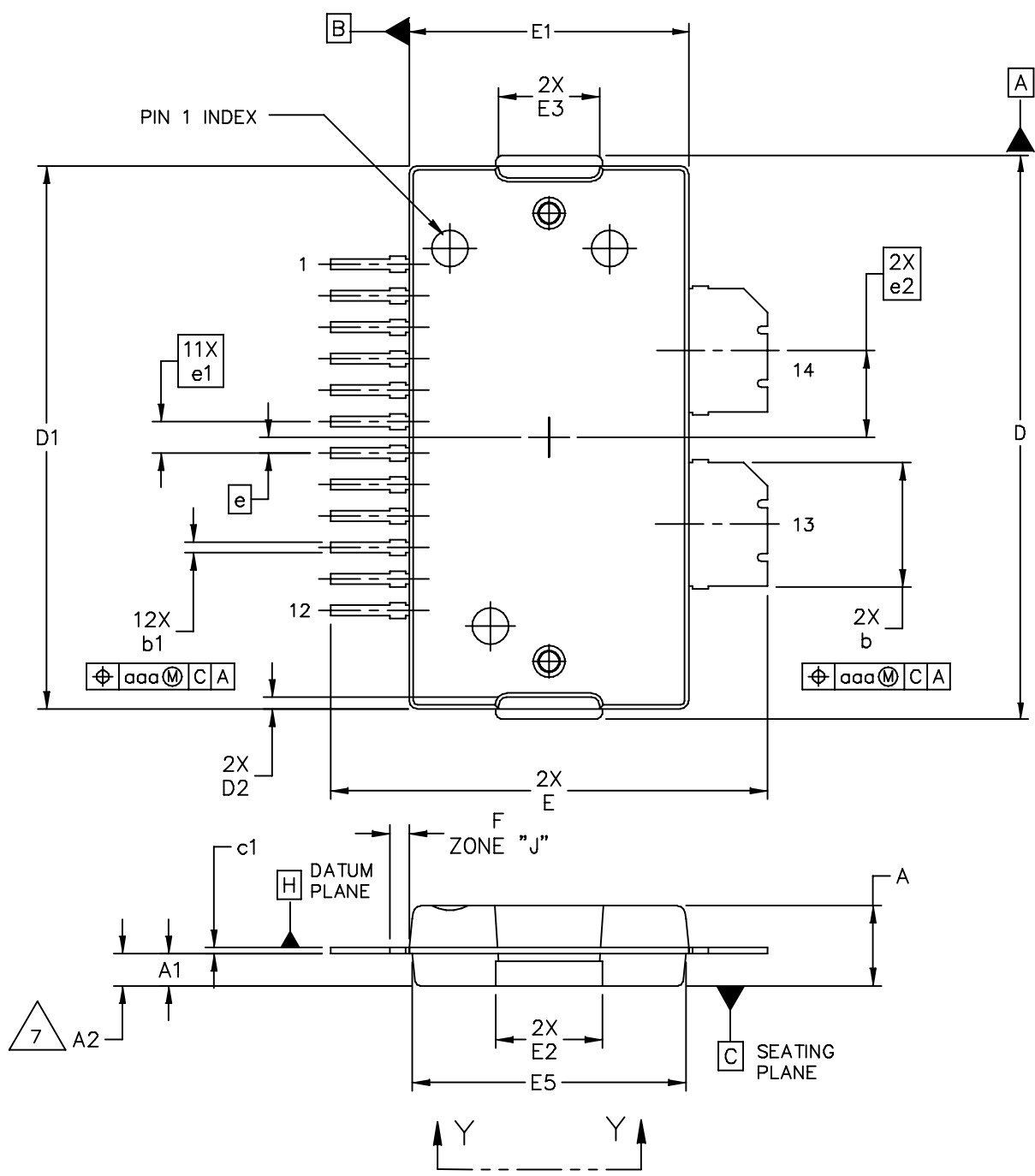
NOTES:

1. CONTROLLING DIMENSION: INCH
2. INTERPRET DIMENSIONS AND TOLERANCES PER ASME Y14.5M-1994.
3. DATUM PLANE -H- IS LOCATED AT THE TOP OF LEAD AND IS COINCIDENT WITH THE LEAD WHERE THE LEAD EXITS THE PLASTIC BODY AT THE TOP OF THE PARTING LINE.
4. DIMENSIONS "D" AND "E1" DO NOT INCLUDE MOLD PROTRUSION. ALLOWABLE PROTRUSION IS .006 (0.15) PER SIDE. DIMENSIONS "D" AND "E1" DO INCLUDE MOLD MISMATCH AND ARE DETERMINED AT DATUM PLANE -H-.
5. DIMENSIONS "b" AND "b1" DO NOT INCLUDE DAMBAR PROTRUSION. ALLOWABLE DAMBAR PROTRUSION SHALL BE .005 (0.13) TOTAL IN EXCESS OF THE "b" AND "b1" DIMENSIONS AT MAXIMUM MATERIAL CONDITION.
6. HATCHING REPRESENTS THE EXPOSED AREA OF THE HEAT SLUG.
7. DIM A2 APPLIES WITHIN ZONE "J" ONLY.

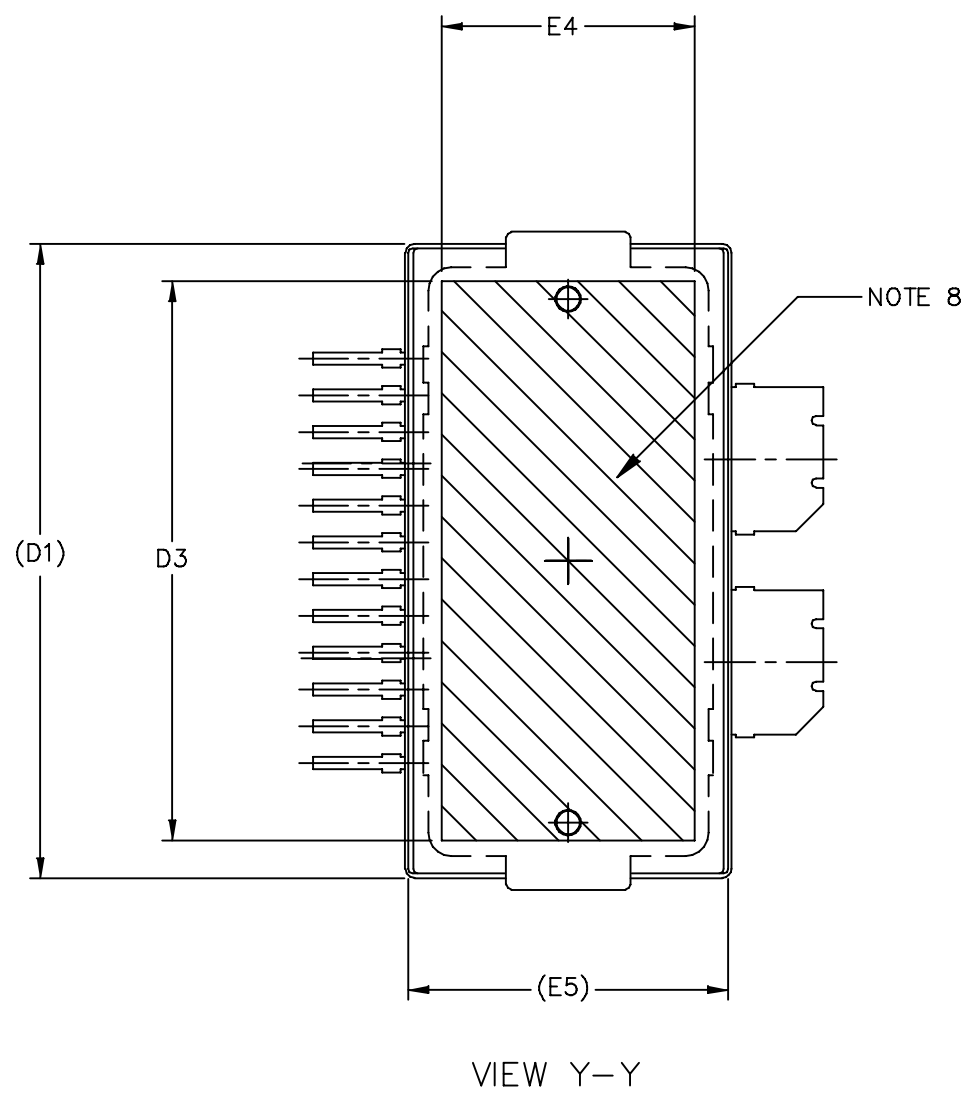
ARCHIVE INFORMATION

ARCHIVE INFORMATION

| DIM   | INCH     |      | MILLIMETER         |       | DIM                      | INCH                       |      | MILLIMETER  |      |
|---|----------|------|--------------------|-------|--------------------------|----------------------------|------|-------------|------|
|   | MIN      | MAX  | MIN                | MAX   |                          | MIN                        | MAX  | MIN         | MAX  |
| A   | .100     | .104 | 2.54               | 2.64  | b                        | .154                       | .160 | 3.91        | 4.06 |
| A1  | .039     | .043 | 0.99               | 1.09  | b1                       | .010                       | .016 | 0.25        | 0.41 |
| A2  | .040     | .042 | 1.02               | 1.07  | c1                       | .007                       | .011 | 0.18        | 0.28 |
| D   | .928     | .932 | 23.57              | 23.67 | e                        | .020 BSC                   |      | 0.51 BSC    |      |
| D1  | .810 BSC |      | 20.57 BSC          |       | e1                       | .040 BSC                   |      | 1.02 BSC    |      |
| E   | .551     | .559 | 14.00              | 14.20 | e2                       | .1105 BSC                  |      | 2.807 BSC   |      |
| E1  | .353     | .357 | 8.97               | 9.07  | r1                       | .063                       | .068 | 1.6         | 1.73 |
| E2  | .346     | .350 | 8.79               | 8.89  |                          |                            |      |             |      |
| F   | .025 BSC |      | 0.64 BSC           |       | aaa                      | .004                       |      | 0.10        |      |
| M   | .600     | ---- | 15.24              | ----  |                          |                            |      |             |      |
| N   | .270     | ---- | 6.86               | ----  |                          |                            |      |             |      |
| © FREESCALE SEMICONDUCTOR, INC.<br>ALL RIGHTS RESERVED. |          |      | MECHANICAL OUTLINE |       |                          | PRINT VERSION NOT TO SCALE |      |             |      |
| TITLE:<br><br>TO-272 WIDE BODY<br>14 LEAD               |          |      |                    |       | DOCUMENT NO: 98ASA10649D |                            |      | REV: A      |      |
|   |          |      |                    |       | CASE NUMBER: 1617-02     |                            |      | 27 JUN 2007 |      |
|   |          |      |                    |       | STANDARD: NON-JEDEC      |                            |      |             |      |



|   |  |                          |  |                            |  |
|---|--|--------------------------|--|----------------------------|--|
| © FREESCALE SEMICONDUCTOR, INC.<br>ALL RIGHTS RESERVED. |  | MECHANICAL OUTLINE       |  | PRINT VERSION NOT TO SCALE |  |
| TITLE:<br>TO-270 WIDE BODY<br>14 LEAD                   |  | DOCUMENT NO: 98ASA10650D |  | REV: A                     |  |
|   |  | CASE NUMBER: 1618-02     |  | 19 JUN 2007                |  |
|   |  | STANDARD: NON-JEDEC      |  |                            |  |



|   |                          |                            |  |
|---|--------------------------|----------------------------|--|
| © FREESCALE SEMICONDUCTOR, INC.<br>ALL RIGHTS RESERVED. | MECHANICAL OUTLINE       | PRINT VERSION NOT TO SCALE |  |
| TITLE:<br>TO-270 WIDE BODY<br>14 LEAD                   | DOCUMENT NO: 98ASA10650D | REV: A                     |  |
|   | CASE NUMBER: 1618-02     | 19 JUN 2007                |  |
|   | STANDARD: NON-JEDEC      |                            |  |



NOTES:

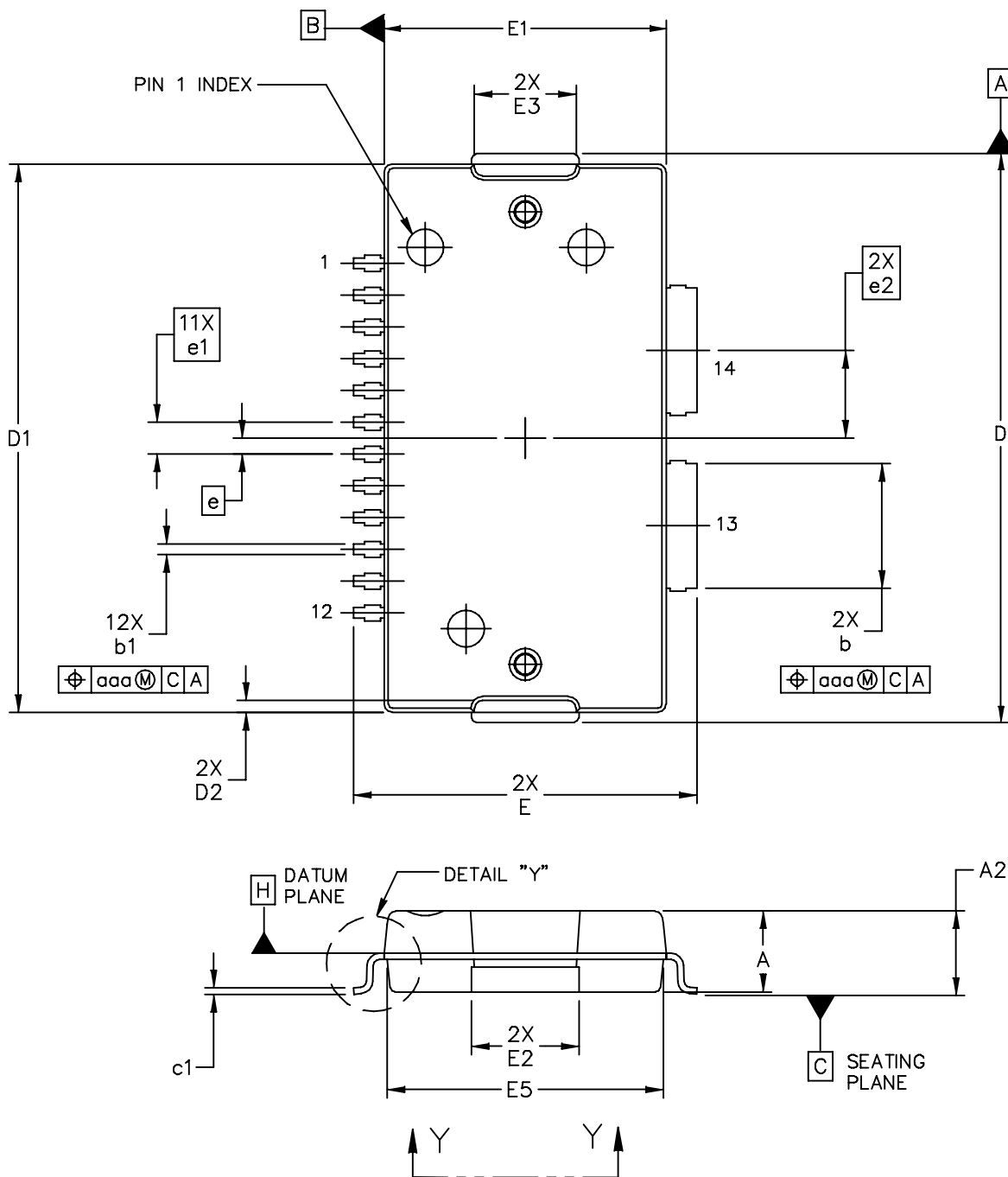
1. CONTROLLING DIMENSION: INCH
2. INTERPRET DIMENSIONS AND TOLERANCES PER ASME Y14.5M-1994.
3. DATUM PLANE -H- IS LOCATED AT THE TOP OF LEAD AND IS COINCIDENT WITH THE LEAD WHERE THE LEAD EXITS THE PLASTIC BODY AT THE TOP OF THE PARTING LINE.
4. DIMENSIONS "D" AND "E1" DO NOT INCLUDE MOLD PROTRUSION. ALLOWABLE PROTRUSION IS .006 PER SIDE. DIMENSIONS "D" AND "E1" DO INCLUDE MOLD MISMATCH AND ARE DETERMINED AT DATUM PLANE -H-.
5. DIMENSIONS "b" AND "b1" DOES NOT INCLUDE DAMBAR PROTRUSION. ALLOWABLE DAMBAR PROTRUSION SHALL BE .005 TOTAL IN EXCESS OF THE "b" AND "b1" DIMENSION AT MAXIMUM MATERIAL CONDITION.
6. DATUMS -A- AND -B- TO BE DETERMINED AT DATUM PLANE -H-.
7. DIMENSION A2 APPLIES WITHIN ZONE "J" ONLY.
8. HATCHING REPRESENTS THE EXPOSED AREA OF THE HEAT SLUG.

ARCHIVE INFORMATION

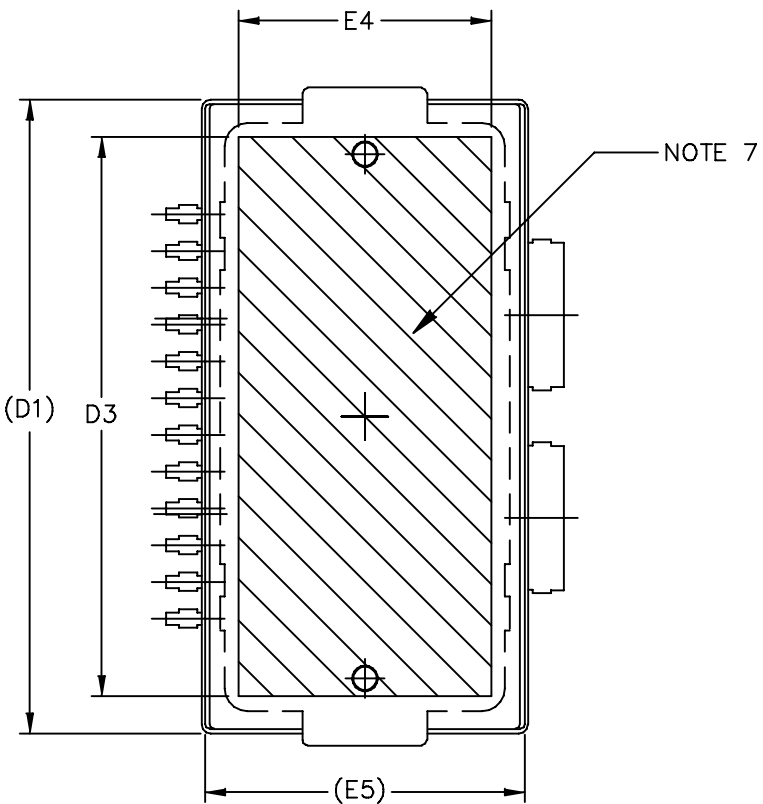
ARCHIVE INFORMATION

| DIM | INCH |      | MILLIMETER |       | DIM | INCH      |      | MILLIMETER |      |
|-----|------|------|------------|-------|-----|-----------|------|------------|------|
|     | MIN  | MAX  | MIN        | MAX   |     | MIN       | MAX  | MIN        | MAX  |
| A   | .100 | .104 | 2.54       | 2.64  | F   | .025 BSC  |      | 0.64 BSC   |      |
| A1  | .039 | .043 | 0.99       | 1.09  | b   | .154      | .160 | 3.91       | 4.06 |
| A2  | .040 | .042 | 1.02       | 1.07  | b1  | .010      | .016 | 0.25       | 0.41 |
| D   | .712 | .720 | 18.08      | 18.29 | c1  | .007      | .011 | .18        | .28  |
| D1  | .688 | .692 | 17.48      | 17.58 | e   | .020 BSC  |      | 0.51 BSC   |      |
| D2  | .011 | .019 | 0.28       | 0.48  | e1  | .040 BSC  |      | 1.02 BSC   |      |
| D3  | .600 | ---  | 15.24      | ---   | e2  | .1105 BSC |      | 2.807 BSC  |      |
| E   | .551 | .559 | 14         | 14.2  |     |           |      |            |      |
| E1  | .353 | .357 | 8.97       | 9.07  | aaa | .004      |      | .10        |      |
| E2  | .132 | .140 | 3.35       | 3.56  |     |           |      |            |      |
| E3  | .124 | .132 | 3.15       | 3.35  |     |           |      |            |      |
| E4  | .270 | ---  | 6.86       | ---   |     |           |      |            |      |
| E5  | .346 | .350 | 8.79       | 8.89  |     |           |      |            |      |

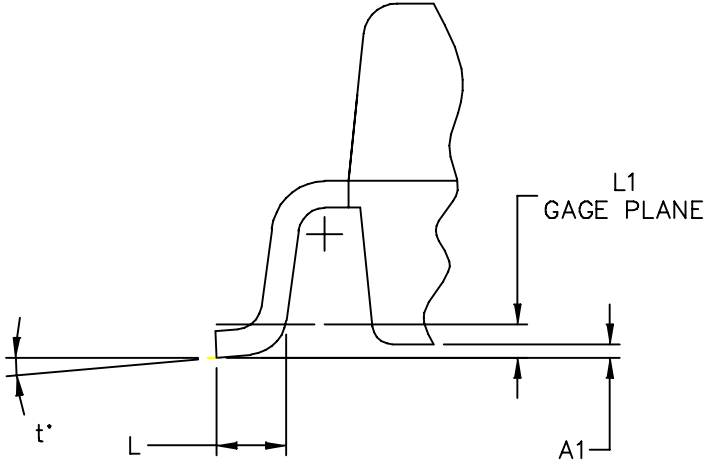
|   |  |                    |                          |                            |             |
|---|--|--------------------|--------------------------|----------------------------|-------------|
| © FREESCALE SEMICONDUCTOR, INC.<br>ALL RIGHTS RESERVED. |  | MECHANICAL OUTLINE |                          | PRINT VERSION NOT TO SCALE |             |
| TITLE:<br>TO-270 WIDE BODY<br>14 LEAD                   |  |                    | DOCUMENT NO: 98ASA10650D |                            | REV: A      |
|   |  |                    | CASE NUMBER: 1618-02     |                            | 19 JUN 2007 |
|   |  |                    | STANDARD: NON-JEDEC      |                            |             |



|   |                          |                            |  |
|---|--------------------------|----------------------------|--|
| © FREESCALE SEMICONDUCTOR, INC.<br>ALL RIGHTS RESERVED. | MECHANICAL OUTLINE       | PRINT VERSION NOT TO SCALE |  |
| TITLE: TO-270 WIDE BODY<br>14 LEAD<br>GULL WING         | DOCUMENT NO: 98ASA10653D | REV: A                     |  |
|   | CASE NUMBER: 1621-02     | 19 JUN 2007                |  |
|   | STANDARD: NON-JEDEC      |                            |  |



VIEW Y-Y



DETAIL "Y"

ARCHIVE INFORMATION

ARCHIVE INFORMATION

|   |                          |                    |                            |
|---|--------------------------|--------------------|----------------------------|
| © FREESCALE SEMICONDUCTOR, INC.<br>ALL RIGHTS RESERVED. |                          | MECHANICAL OUTLINE | PRINT VERSION NOT TO SCALE |
| TITLE: TO-270 WIDE BODY<br>14 LEAD<br>GULL WING         | DOCUMENT NO: 98ASA10653D |                    | REV: A                     |
|   | CASE NUMBER: 1621-02     |                    | 19 JUN 2007                |
|   | STANDARD: NON-JEDEC      |                    |                            |

NOTES:

1. CONTROLLING DIMENSION: INCH
2. INTERPRET DIMENSIONS AND TOLERANCES PER ASME Y14.5M-1994.
3. DATUM PLANE -H- IS LOCATED AT THE TOP OF LEAD AND IS COINCIDENT WITH THE LEAD WHERE THE LEAD EXITS THE PLASTIC BODY AT THE TOP OF THE PARTING LINE.
4. DIMENSIONS "D" AND "E1" DO NOT INCLUDE MOLD PROTRUSION. ALLOWABLE PROTRUSION IS .006 PER SIDE. DIMENSIONS "D" AND "E1" DO INCLUDE MOLD MISMATCH AND ARE DETERMINED AT DATUM PLANE -H-.
5. DIMENSIONS "b" AND "b1" DOES NOT INCLUDE DAMBAR PROTRUSION. ALLOWABLE DAMBAR PROTRUSION SHALL BE .005 TOTAL IN EXCESS OF THE "b" AND "b1" DIMENSION AT MAXIMUM MATERIAL CONDITION.
6. DATUMS -A- AND -B- TO BE DETERMINED AT DATUM PLANE -H-.
7. HATCHING REPRESENTS THE EXPOSED AREA OF THE HEAT SLUG.

ARCHIVE INFORMATION

ARCHIVE INFORMATION

| DIM | INCH |      | MILLIMETER |       | DIM | INCH      |      | MILLIMETER |      |
|-----|------|------|------------|-------|-----|-----------|------|------------|------|
|     | MIN  | MAX  | MIN        | MAX   |     | MIN       | MAX  | MIN        | MAX  |
| A   | .100 | .104 | 2.54       | 2.64  | L   | .018      | .024 | 0.46       | 0.61 |
| A1  | .001 | .004 | 0.02       | 0.10  | L1  | .010 BSC  |      | 0.25 BSC   |      |
| A2  | .099 | .110 | 2.51       | 2.79  | b   | .154      | .160 | 3.91       | 4.06 |
| D   | .712 | .720 | 18.08      | 18.29 | b1  | .010      | .016 | 0.25       | 0.41 |
| D1  | .688 | .692 | 17.48      | 17.58 | c1  | .007      | .011 | .18        | .28  |
| D2  | .011 | .019 | 0.28       | 0.48  | e   | .020 BSC  |      | 0.51 BSC   |      |
| D3  | .600 | ---  | 15.24      | ---   | e1  | .040 BSC  |      | 1.02 BSC   |      |
| E   | .429 | .437 | 10.9       | 11.1  | e2  | .1105 BSC |      | 2.807 BSC  |      |
| E1  | .353 | .357 | 8.97       | 9.07  | t   | 2°        | 8°   | 2°         | 8°   |
| E2  | .132 | .140 | 3.35       | 3.56  |     |           |      |            |      |
| E3  | .124 | .132 | 3.15       | 3.35  | aaa | .004      |      | .10        |      |
| E4  | .270 | ---  | 6.86       | ---   |     |           |      |            |      |
| E5  | .346 | .350 | 8.79       | 8.89  |     |           |      |            |      |

|   |  |                    |                          |                            |             |
|---|--|--------------------|--------------------------|----------------------------|-------------|
| © FREESCALE SEMICONDUCTOR, INC.<br>ALL RIGHTS RESERVED. |  | MECHANICAL OUTLINE |                          | PRINT VERSION NOT TO SCALE |             |
| TITLE: TO-270 WIDE BODY<br>14 LEAD<br>GULL WING         |  |                    | DOCUMENT NO: 98ASA10653D |                            | REV: A      |
|   |  |                    | CASE NUMBER: 1621-02     |                            | 19 JUN 2007 |
|   |  |                    | STANDARD: NON-JEDEC      |                            |             |

## PRODUCT DOCUMENTATION

Refer to the following documents to aid your design process.

### Application Notes

- AN1907: Solder Reflow Attach Method for High Power RF Devices in Plastic Packages
- AN1955: Thermal Measurement Methodology of RF Power Amplifiers
- AN1987: Quiescent Current Control for the RF Integrated Circuit Device Family
- AN3263: Bolt Down Mounting Method for High Power RF Transistors and RFICs in Over-Molded Plastic Packages

### Engineering Bulletins

- EB212: Using Data Sheet Impedances for RF LDMOS Devices

## REVISION HISTORY

The following table summarizes revisions to this document.

| Revision | Date      | Description  |
|----------|-----------|--|
| 0        | Feb. 2007 | <ul style="list-style-type: none"> <li>• Initial Release of Data Sheet</li> </ul>  |
| 1        | May 2007  | <ul style="list-style-type: none"> <li>• Changed Device box to 960 MHz to reflect functional test frequency, p. 1</li> <li>• Added Power Added Efficiency to GSM EDGE Application Typical Performances, p. 1</li> <li>• Changed "5:1 VSWR, @ 28 Vdc" to "10:1 VSWR, @ 32 Vdc" in the Capable of Handling bullet, p. 1</li> <li>• Added Footnote (1) to Quiescent Current Thermal Tracking bullet under Features section and to Quiescent Current Temperature Compensation in Fig. 1, Functional Block Diagram, p. 1</li> <li>• Added top-level, 2-stage block diagram depiction to Fig. 2, Pin Connections; updated Note, p. 1</li> <li>• Added Case Operating Temperature limit to the Maximum Ratings table and set limit to 150°C, p. 2</li> <li>• Added Stage 1 and Stage 2 DC Electrical Characteristics tables, p. 2, 3</li> <li>• In Table 6, Component Designations and Values, corrected Part Number ATC100B331JT500XT to ATC100B331JT200XT for C24 capacitor, p. 4</li> <li>• Updated Figs. 7 and 8, Power Gain versus Output Power, to remove non-variable <math>I_{DQ}</math> value, p. 6</li> <li>• Updated Fig. 9, Intermodulation Distortion Products versus Output Power, to show PEP and not CW; corrected frequency value to show 100 kHz Tone Spacing, p. 7</li> <li>• Updated graphical representation of Ideal/Actual in Fig. 11, Pulsed CW Output Power versus Input Power, to show correct 3 and 6 dB compression points, p. 7</li> </ul>   |
| 2        | June 2007 | <ul style="list-style-type: none"> <li>• Removed Case Operating Temperature from Maximum Ratings table, p. 2. Case Operating Temperature rating will be added to the Maximum Ratings table when parts' Operating Junction Temperature is increased to 225°C.</li> </ul>  |
| 3        | Dec. 2008 | <ul style="list-style-type: none"> <li>• Changed full frequency band in Typical GSM Performance bullet to <math>f = 960</math> MHz to match actual production test, p. 1</li> <li>• Changed Storage Temperature Range in Max Ratings table from -65 to +200 to -65 to +150 for standardization across products, p. 2</li> <li>• Added Case Operating Temperature limit to the Maximum Ratings table and set limit to 150°C, p. 2</li> <li>• Operating Junction Temperature increased from 200°C to 225°C in Maximum Ratings table, related "Continuous use at maximum temperature will affect MTTF" footnote added and changed 200°C to 225°C in Capable Plastic Package bullet, p. 1, 2</li> <li>• Corrected Z10 from 1.17" to 0.117" in the Test Circuit Schematic Z list, p. 4</li> <li>• Updated Part Numbers in Table 6, Component Designations and Values, to latest RoHS compliant part numbers, p. 4</li> <li>• Replaced Case Outline 1617-01 with 1617-02, Issue A, p. 1, 13-15. Revised cross-hatched area for exposed heat spreader. Added pin numbers 1, 12, 13, and 14 to Sheets 1 and 2. Corrected mm Min and Max values for dimension A1 to 0.99 and 1.09, respectively.</li> <li>• Replaced Case Outline 1618-01 with 1618-02, Issue A, p. 1, 16-18. Added pin numbers 1, 12, 13, and 14 and Pin 1 Index designation to Sheet 1. Corrected dimensions e and e1 on Sheet 1. Removed Pin 5 designation from Sheet 2.</li> <li>• Replaced Case Outline 1621-01 with 1621-02, Issue A, p. 1, 19-21. Added pin numbers 1, 12, 13, and 14 and Pin 1 Index designation to Sheet 1. Corrected dimensions e and e1 on Sheets 1 and 3. Removed Pin 5 designation from Sheet 2.</li> <li>• Added Product Documentation and Revision History, p. 22</li> </ul> |

ARCHIVE INFORMATION

ARCHIVE INFORMATION



**How to Reach Us:**

**Home Page:**

[www.freescale.com](http://www.freescale.com)

**Web Support:**

<http://www.freescale.com/support>

**USA/Europe or Locations Not Listed:**

Freescale Semiconductor, Inc.  
 Technical Information Center, EL516  
 2100 East Elliot Road  
 Tempe, Arizona 85284  
 1-800-521-6274 or +1-480-768-2130  
[www.freescale.com/support](http://www.freescale.com/support)

**Europe, Middle East, and Africa:**

Freescale Halbleiter Deutschland GmbH  
 Technical Information Center  
 Schatzbogen 7  
 81829 Muenchen, Germany  
 +44 1296 380 456 (English)  
 +46 8 52200080 (English)  
 +49 89 92103 559 (German)  
 +33 1 69 35 48 48 (French)  
[www.freescale.com/support](http://www.freescale.com/support)

**Japan:**

Freescale Semiconductor Japan Ltd.  
 Headquarters  
 ARCO Tower 15F  
 1-8-1, Shimo-Meguro, Meguro-ku,  
 Tokyo 153-0064  
 Japan  
 0120 191014 or +81 3 5437 9125  
[support.japan@freescale.com](mailto:support.japan@freescale.com)

**Asia/Pacific:**

Freescale Semiconductor China Ltd.  
 Exchange Building 23F  
 No. 118 Jianguo Road  
 Chaoyang District  
 Beijing 100022  
 China  
 +86 10 5879 8000  
[support.asia@freescale.com](mailto:support.asia@freescale.com)

**For Literature Requests Only:**

Freescale Semiconductor Literature Distribution Center  
 P.O. Box 5405  
 Denver, Colorado 80217  
 1-800-441-2447 or +1-303-675-2140  
 Fax: +1-303-675-2150  
[LDCForFreescaleSemiconductor@hibbertgroup.com](mailto:LDCForFreescaleSemiconductor@hibbertgroup.com)

Information in this document is provided solely to enable system and software implementers to use Freescale Semiconductor products. There are no express or implied copyright licenses granted hereunder to design or fabricate any integrated circuits or integrated circuits based on the information in this document.

Freescale Semiconductor reserves the right to make changes without further notice to any products herein. Freescale Semiconductor makes no warranty, representation or guarantee regarding the suitability of its products for any particular purpose, nor does Freescale Semiconductor assume any liability arising out of the application or use of any product or circuit, and specifically disclaims any and all liability, including without limitation consequential or incidental damages. "Typical" parameters that may be provided in Freescale Semiconductor data sheets and/or specifications can and do vary in different applications and actual performance may vary over time. All operating parameters, including "Typicals", must be validated for each customer application by customer's technical experts. Freescale Semiconductor does not convey any license under its patent rights nor the rights of others. Freescale Semiconductor products are not designed, intended, or authorized for use as components in systems intended for surgical implant into the body, or other applications intended to support or sustain life, or for any other application in which the failure of the Freescale Semiconductor product could create a situation where personal injury or death may occur. Should Buyer purchase or use Freescale Semiconductor products for any such unintended or unauthorized application, Buyer shall indemnify and hold Freescale Semiconductor and its officers, employees, subsidiaries, affiliates, and distributors harmless against all claims, costs, damages, and expenses, and reasonable attorney fees arising out of, directly or indirectly, any claim of personal injury or death associated with such unintended or unauthorized use, even if such claim alleges that Freescale Semiconductor was negligent regarding the design or manufacture of the part.

Freescale™ and the Freescale logo are trademarks of Freescale Semiconductor, Inc. All other product or service names are the property of their respective owners.

© Freescale Semiconductor, Inc. 2007-2008. All rights reserved.