



Chipsmall Limited consists of a professional team with an average of over 10 year of expertise in the distribution of electronic components. Based in Hongkong, we have already established firm and mutual-benefit business relationships with customers from,Europe,America and south Asia,supplying obsolete and hard-to-find components to meet their specific needs.

With the principle of "Quality Parts,Customers Priority,Honest Operation,and Considerate Service",our business mainly focus on the distribution of electronic components. Line cards we deal with include Microchip,ALPS,ROHM,Xilinx,Pulse,ON,Everlight and Freescale. Main products comprise IC,Modules,Potentiometer,IC Socket,Relay,Connector.Our parts cover such applications as commercial,industrial, and automotives areas.

We are looking forward to setting up business relationship with you and hope to provide you with the best service and solution. Let us make a better world for our industry!



Contact us

Tel: +86-755-8981 8866 Fax: +86-755-8427 6832

Email & Skype: info@chipsmall.com Web: www.chipsmall.com

Address: A1208, Overseas Decoration Building, #122 Zhenhua RD., Futian, Shenzhen, China



Turned contacts Radsok contact 6mm for 35mm²

Part No. N02 060 6118 001

Series Contacts

Subseries Contact Turned contacts



COMMON CHARACTERISTICS

Wire gauge from		35
Wire gauge (AWG) from		2
Packaging / supplied as		Single contact
No. of pieces		1
Sex of Contact		Socket
Type of contact		Turned crimp contact

ELECTRICAL CHARACTERISTICS

Contact resistance	DIN EN 60512-2-1, Test 2a / IEC 60512-2-1, Test 2a	≤ 1 m
--------------------	--	-------

Turned contacts Radsok contact 6mm for 35mm²

Part No. N02 060 6118 001

Series Contacts

Subseries Contact Turned contacts

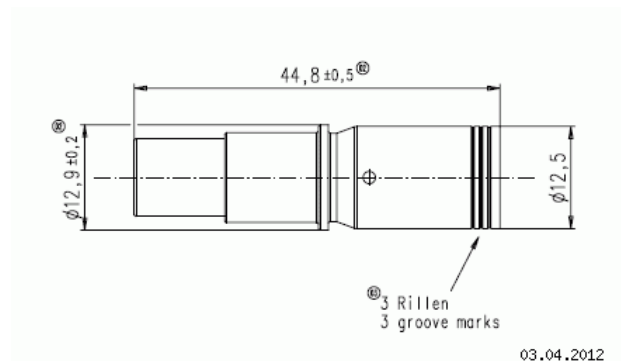

Drawing Dimensions in mm (Inch)