



Chipsmall Limited consists of a professional team with an average of over 10 year of expertise in the distribution of electronic components. Based in Hongkong, we have already established firm and mutual-benefit business relationships with customers from,Europe,America and south Asia,supplying obsolete and hard-to-find components to meet their specific needs.

With the principle of “Quality Parts,Customers Priority,Honest Operation,and Considerate Service”,our business mainly focus on the distribution of electronic components. Line cards we deal with include Microchip,ALPS,ROHM,Xilinx,Pulse,ON,Everlight and Freescale. Main products comprise IC,Modules,Potentiometer,IC Socket,Relay,Connector.Our parts cover such applications as commercial,industrial, and automotives areas.

We are looking forward to setting up business relationship with you and hope to provide you with the best service and solution. Let us make a better world for our industry!



Contact us

Tel: +86-755-8981 8866 Fax: +86-755-8427 6832

Email & Skype: info@chipsmall.com Web: www.chipsmall.com

Address: A1208, Overseas Decoration Building, #122 Zhenhua RD., Futian, Shenzhen, China





N5 ANT SoC Module Series



ANT® Operation (when loaded with the latest S210 or S310 SoftDevice)

- 79 selectable RF channels (2402 to 2480 MHz)
- Simple to complex network topologies: peer-to-peer, star, tree, star-to-star and more
- Broadcast, acknowledged, and burst data communication modes
- Built-in device search and pairing
- Built-in interference handling and radio coexistence management with application radio disable requests and application flash write/erase requests
- Enhanced ANT features
 - Supports up to 15 logical channels each with configurable channel periods (5.2ms - 2s)
 - Advanced burst data transfer modes (up to 60kbps)
 - Optional channel encryption mode (AES-128)
 - Supports up to 8 public, private and/or managed networks
 - Advanced power management features to optimize application power consumption including Event Filtering and Selective data updates
 - Asynchronous transmit channel
 - Fast channel initiation

ANT/BLUETOOTH® Low Energy Peripheral Operation (when loaded with the latest S310 SoftDevice)

- ANT operation functions as S210
- BLUETOOTH 4.1 compliant low energy single-mode protocol stack
 - Link Layer
 - L2CAP, ATT, and SM protocols
 - GATT, GAP, and L2CAP
 - Peripheral and Broadcaster roles
 - GATT Client and Server
 - Full SMP support including MITM and OOB pairing

Module Hardware

- Integrated PCB meander antenna
- On-board 32 kHz and 16 MHz crystal clocks
- 1.8V to 3.6V supply voltage range
- DC/DC converter
- Operating temperature:
 - 25°C to +75°C (N5150 and N548)
 - 40°C to +85°C (N550)
- 24 GPIOs (LGA package)
- Programmable output per channel from -20dBm up to +4dBm
- Excellent receiver sensitivity
 - 90dBm ANT mode
 - 93dBm BLE mode
- 1dBm resolution RSSI
- Total 256kB embedded flash memory and 16kB/32kB RAM
- SPI, I2C and UART interface
- ARM SWD interface
- 14.0x9.8x2.0mm (LGA package)
- Drop-in compatible options with AP2/C7 modules
- Radio regulatory approval for major markets
- BLUETOOTH SIG qualification
- RoHS compliant

Series Members

- N5150M8CD, N5150M4CD, N5150M5CD
- N550M8CC, N550M4CC
- N548M8CB, N548M4CB, N548M5CB

All these modules are pre-loaded with the S210 SoftDevice, the ANT-WP bootloader and an ANT network processor application code

D00001598 Rev.1.8

Contents

1	N5 ANT SoC Module Series	7
1.1	Nomenclature	7
1.2	Production Tracking Code	8
1.3	Models	8
1.4	N5 ANT SoC Module Starter Kit	8
2	Product Overview	10
2.1	Block Diagram	10
2.2	Pin-outs	10
2.3	N5 Module Preloaded Software	12
2.4	N5 Module Programming	12
2.4.1	Programming via SWD Interface	13
2.4.2	Programming Over the Air	13
2.4.3	Initializing the SoftDevice	13
2.4.4	Configuring the DC/DC Converter	13
2.5	Design Considerations	13
2.5.1	M8 Module Mounting	13
2.5.2	M4 Module Mounting	14
2.5.3	M5 Module Mounting	14
2.6	Assembly Considerations	14
2.6.1	Moisture Control	14
2.6.2	Solder Stencil Design of M8 Module	15
2.6.3	Cleaning Process	15
3	Regulatory Approvals and Compliances	16
3.1	United States	16
3.2	Canada	16
3.3	European Economic Area	17
3.4	Australia & New Zealand	17
3.5	Japan	17
3.6	BLUETOOTH Qualification	17
4	Electrical Specifications	18
4.1	Absolute Maximum Ratings	18
4.2	Recommended Operating Conditions	18
4.3	Industrial Temperature Range	18
4.4	Radio Operation Specifications and Antenna Characteristics	18
4.5	Electrical Specifications	20
5	Mechanical Drawings	21
6	Support	24
6.1	ANT Forum	24
6.2	Technical References	24

- 6.3 ANT Developer’s Zone 24
- 6.4 ANT and ANT+ Social Media 25
- Appendix A: Using the ANT Network Processor Configuration 26**
 - 1. Pin Assignments in the ANT Network Processor Configuration 26
 - 2. Asynchronous Serial Mode 27
 - 3. Byte Synchronous Serial Mode 29
 - 4. ANT-WP Bootloader Activation 29
 - Using BOOT Pin 30
 - Using Serial Command 30
 - 5. DC/DC Configuration 31
- Appendix B: Using the ANT Bootloader for OTA Firmware Update 32**
 - 1. Operational Memory Layout 32
 - 2. Entering Bootloader Mode 33
 - 3. Bootloader ANT-FS Functionality 33
 - ANT-FS Configuration 34
 - 4. OTA Firmware Update Procedure 34
 - Example Usage 34
 - Image Activation 36
- Appendix C: N5 Module Pre-Loaded Software Versions 37**
 - 1. Key functional changes in N550 and N5150 37
 - 2. Key functional changes in rev B over rev A 37

Figures

- Figure 1: N5 ANT SoC Module Series Nomenclature 7
- Figure 2: Production Tracking Code 8
- Figure 3: N5 ANT SoC Module Series Block Diagram 10
- Figure 4: N5 M8 LGA Bottom View 10
- Figure 5: N5 M4 Bottom View 10
- Figure 6: N5 M5 Module Bottom View 11
- Figure 7: Memory Map of the Preloaded Software 12
- Figure 8: N5 M8 Module Mounting (all dimensions in mm) 14
- Figure 9: N5 M4 Module Mounting 14
- Figure 10: Solder Stencil Reference 15
- Figure 11: N5 M4 Module Typical Antenna Gain (dBi) 19
- Figure 12: N5 M8 Mechanical Drawing 21
- Figure 13: N5 M4 Mechanical Drawing 22
- Figure 14: N5 M5 Mechanical Drawing 23
- Figure 15: Using ANT Network Processor 26
- Figure 16: N5 M4 ANT NP Configuration Async Serial Connection 28
- Figure 17: N5 M4 ANT NP Configuration Byte Sync Connection 29
- Figure 18: ANT-WP Bootloader Operational Memory Layout 32

Figure 19: ANT Bootloader Topology34
Figure 20: OTA Updater to PC Application35

Tables

Table 1: N5 ANT SoC Module Series Offerings.....8
Table 2: N5 ANT SoC Module Starter Kit9
Table 3: N5 ANT SoC Module Pin-Outs.....11
Table 4: Absolute Maximum Ratings18
Table 5: Recommended Operating Conditions18
Table 6: N5 Module Antenna Gain18
Table 7: Current Consumption of Radio Operation.....19
Table 8: Pin Assignments in ANT Network Processor Configuration27
Table 9: Asynchronous Serial Mode Baud Rate Select27
Table 10 Byte-Sync Mode Speed Selection29
Table 11: ANT OTA Update Enable Command30
Table 12: ANT OTA Update Enable Response.....30
Table 11: ANT DC/DC Configuration Command31
Table 12: ANT DC/DC Configuration Response.....31
Table 13: Summary of the ANT-WP Bootloader Operational Memory Layout.....33
Table 14: ANT-WP Bootloader Default ANT Channel Parameters34
Table 15: ANT-WP Bootloader ANT-FS Device Identification Parameters34
Table 16: N5 Module Versions and Factory Loaded Software37

Notices and Restricted Use Information

Information contained in this document is provided only for your ("Customer" or "you") convenience and may be superseded by updates. It is your responsibility to ensure that your application meets with your specifications.

Dynastream Innovations Inc. ("DYNASTREAM") makes no representations or warranties of any kind whether express or implied, written or oral, statutory or otherwise, related to the information, including but not limited to its condition, quality, performance, merchantability or fitness for purpose. DYNASTREAM disclaims all liability arising from this information and its use.

DYNASTREAM does not assume any responsibility for the use of the described ANT module ("the Module(s)"). Dynastream makes no representation with respect to the adequacy of the module in low-power wireless data communications applications or systems. Any Products using the Module must be designed so that a loss of communications due to radio interference or otherwise will not endanger either people or property, and will not cause the loss of valuable data. DYNASTREAM assumes no liability for the performance of products which are designed or created using the Modules.

The Modules are not designed, intended, or authorized for use as components in systems intended for surgical implant into the body, or other applications intended to support or sustain life, or for any other application in which the failure of the Module could create a situation where personal injury or death may occur. If you use the Modules for such unintended and unauthorized applications, you do so at your own risk and you shall indemnify and hold DYNASTREAM and its officers, employees, subsidiaries, affiliates, and distributors harmless against all claims, costs, damages, and expenses, and reasonable attorney fees arising out of, directly or indirectly, any claim of personal injury or death associated with such unintended or unauthorized use, even if such claim alleges that DYNASTREAM was negligent regarding the design or manufacture of the Product.

The information disclosed herein is the exclusive property of DYNASTREAM, and is not to be reproduced and/or distributed without the written consent of DYNASTREAM. No part of this publication may be reproduced or transmitted in any form or by any means including electronic storage, reproduction, execution or transmission without the prior written consent of DYNASTREAM. The recipient of this document by its retention and use agrees to respect the security status of the information contained herein.

DYNASTREAM believes the information contained herein is correct and accurate at the time of its release. However, the information contained in this document is subject to change without notice and should not be construed as a commitment by DYNASTREAM unless such commitment is expressly given in a covering document.

One Year Limited Warranty

This product is warranted to be free from defects in materials or workmanship for 1 year from the date of purchase of the end customer. Within this period, Dynastream Innovations Inc. (Dynastream) will, at its sole option, replace any products that fail in normal use. Such replacement will be made at no charge to distributors or companies who purchase this product directly from Dynastream, provided the distributor or company shall be responsible for any transportation cost. This warranty does not apply to: (i) cosmetic damage, such as scratches, nicks and dents; (ii) damage caused by accident, abuse, misuse, water, flood, fire, or other acts of nature or external causes; (iii) damage caused by service performed by anyone who is not an authorized service provider of Dynastream; (iv) damage to a product that has been modified or altered without the written permission of Dynastream. In addition, Dynastream reserves the right to refuse warranty claims against products or services that are obtained and/or used in contravention of the laws of any country.

Replaced products have 1 year warranty as stipulated in this term.

THE WARRANTIES AND REMEDIES CONTAINED HEREIN ARE EXCLUSIVE AND IN LIEU OF ALL OTHER WARRANTIES EXPRESS, IMPLIED, OR STATUTORY, INCLUDING ANY LIABILITY ARISING UNDER ANY WARRANTY OF MERCHANTABILITY OR FITNESS FOR A PARTICULAR PURPOSE, STATUTORY OR OTHERWISE.

IN NO EVENT SHALL DYNASTREAM BE LIABLE FOR ANY INCIDENTAL, SPECIAL, INDIRECT, OR CONSEQUENTIAL DAMAGES, WHETHER RESULTING FROM THE USE, MISUSE, OR INABILITY TO USE THIS PRODUCT OR FROM DEFECTS IN THE PRODUCT.

Dynastream retains the exclusive right to replace (with a new or newly-overhauled replacement product) the device or software or offer a full refund of the purchase price at its sole discretion. SUCH REMEDY SHALL BE THE SOLE AND EXCLUSIVE REMEDY FOR ANY BREACH OF WARRANTY.

To obtain warranty service, the distributor or company shall contact Dynastream for shipping instructions and a return material authorization (RMA) tracking number. Securely pack the device and a copy of the original sales receipt, which is required as the proof of purchase for warranty claims. Write the tracking number clearly on the outside of the package. Send the device, freight charges prepaid, to Dynastream.

©2015 Dynastream Innovations Inc. All Rights Reserved.

1 N5 ANT SoC Module Series

Based on Nordic Semiconductor’s nRF51422 SoC, the N5 ANT SoC module series offers support for both ANT® and Bluetooth® low energy and enables both protocols to run concurrently, depending on the loaded protocol stack.

The N5 ANT SoC module series starts with the M8 model in a 14.0mm x 9.8mm x 2.0mm LGA (Land Array Grid) package. A compact design meeting the market requirements for small, light and wearable, the M8 model is a turnkey system hardware solution including antenna, onboard 32 kHz and 16 MHz crystal clocks, DC/DC converter and 24 GPIOs with 6 analogue inputs.

The N5 modules are pre-programmed with the following software components:

- S210 SoftDevice (scalable ANT protocol stack with max. 15 channels)
- ANT network processor application
- ANT-WP (Wireless Programming) bootloader

SoftDevices are protocol stack solutions from Nordic Semiconductor for the nRF51 SoCs. There are multiple SoftDevice choices available from the Nordic Semiconductor’s web site. The ANT network processor application provides the standard ANT serial interface front-end that is connectable to an external application controller. The ANT-WP bootloader allows over-the-air updates of any software components on the N5 module.

The N5 module’s pre-programmed image can be easily replaced via the onboard SWD interface pins using off-the-shelf ARM programming tools or over the air using the pre-loaded ANT-WP bootloader.

Pin compatible options for the 20mm x 20mm AP2 or C7 modules from Dynastream are also available. In these M4 and M5 model options, N5 M8 models are soldered on carrier boards that are pin compatible to the previous modules. Current AP2 or C7 module customers can easily use these models to evaluate the hardware and upgrade their products.

The N5 module series, if loaded with the ANT and/or BLUETOOTH low energy stack has been certified to comply with radio regulation or standards covering major markets include North America, Europe, Australia, New Zealand and Japan. The N5 ANT SoC modules series has also been qualified by the BLUETOOTH SIG.

1.1 Nomenclature

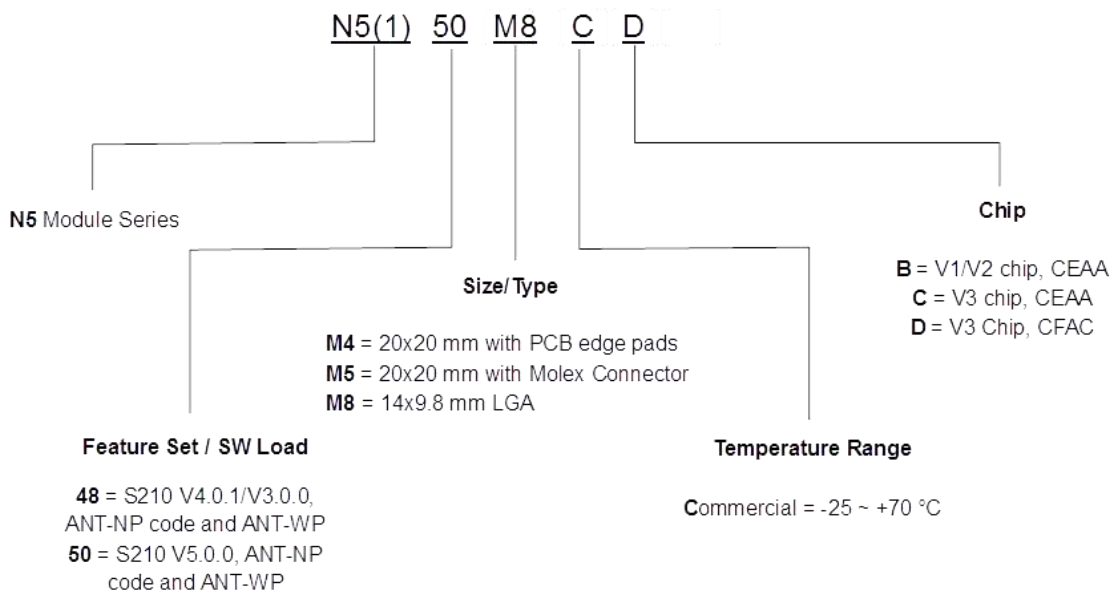

Figure 1: N5 ANT SoC Module Series Nomenclature

1.2 Production Tracking Code

For technical support and customer service purposes, a production code of three characters is laser marked on the RF shield as illustrated below. In the code, YW denotes production date code and R denotes module version.

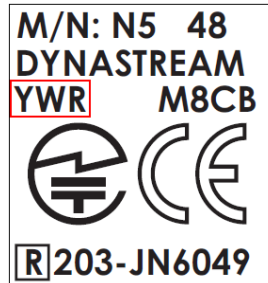
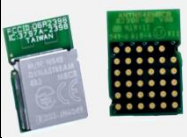



Figure 2: Production Tracking Code

Please refer to Appendix C: N5 Module Pre-Loaded Software Versions for differences and important notes of each version.

1.3 Models

	Part Number	Size (mm)	Connection	Chip	RAM Size	Preloaded Software		
						SoftDevice	ANT-NP	ANT-WP
	N5150M8CD	14.0 x 9.8 x 2.0	LGA package, 31 pads, 24 GPIOs.	nRF51422-CFAC, V3	32k	S210 V5.0.0	BAW4.0 0B00	BFD2.00 B00
	N550M8CC			nRF51422-CEAA, V3	16k			
	N548M8CB ⁽¹⁾			nRF51422-CEAA, V2	16k			
	N5150M4CD	20.0 x 20.0	17 pins, SMT mount, 13 GPIOs	nRF51422-CFAC, V3	32k	S210 V5.0.0	BAW4.0 0B00	BFD2.00 B00
	N550M4CC			nRF51422-CEAA, V3	16k			
	N548M4CB ⁽¹⁾			nRF51422-CEAA, V2	16k			
	N5150M5CD	20.0 x 20.0	20 pin Molex connector. Onboard JTAG programming connector. 13 GPIOs	nRF51422-CFAC, V3	32k	S210 V5.0.0	BAW4.0 0B00	BFD2.00 B00
	N548M5CB ⁽¹⁾			nRF51422-CEAA, V2	16k			





Note 1: Applies to rev B. Rev A module are pre-loaded with S210 V3.0.0 and BAW2.02B00 ANT NP code.

Table 1: N5 ANT SoC Module Series Model List

1.4 N5 ANT SoC Module Starter Kit

The N5 ANT SoC Module Starter Kit, ordering number "N5DK1", contains all the pieces you need to start evaluation and development using the N5 ANT SoC module, as well as the nRF51422 IC.

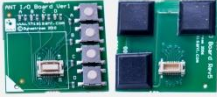
The kit contains the following hardware pieces as described in Table 2, with a pre-loaded application ready to be demonstrated when opening the box. Additional reference application code is available on www.dynastream.com/N5starterkit. Most of the parts are orderable individually to create a more complex network.

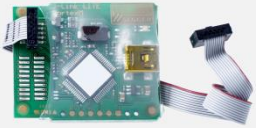
Order Number	Part Description	Quantity	
N5150M5CD*	Module with 20-pin Molex connector	2	
ANTBAT2	Battery board with a Molex socket, a reset button and a five-position dip switch	1	
ANTIO1	I/O board with a Molex connector, a Molex socket, 4 LEDs and 4 buttons	1	
ANTUIF1	USB Interface Board with a Molex socket	1	
	Segger J-Link Lite Programmer	1	

Note: Starter kits before the release of N5150M5CD contain N548M5CB instead.

Table 2: N5 ANT SoC Module Starter Kit

2 Product Overview

2.1 Block Diagram

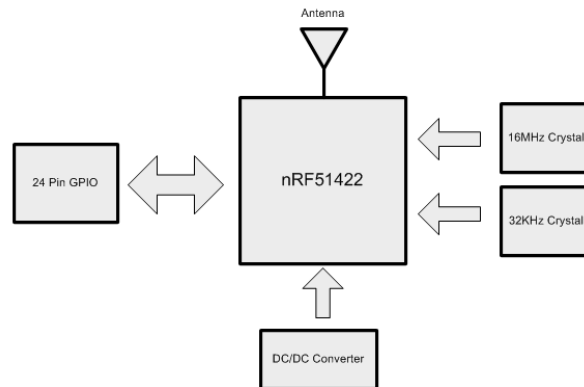
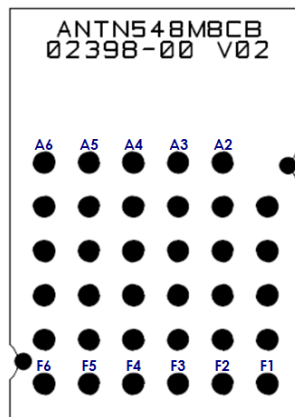

Figure 3: N5 ANT SoC Module Series Block Diagram

2.2 Pin-outs



	6	5	4	3	2	1
A	GND	GND	GND	GND	GND	
B	VCC	VCC	P019	P020	P018	RST/SWDIO
C	VCC	VCC	P022	P016	P013	SWDCLK
D	P024	P021	P023	P025	P015	P012
E	P030	P000	P004	P006	P011	P009
F	P031	P002	P001	P003	P005	P008

Figure 4: N5 M8 LGA Bottom View

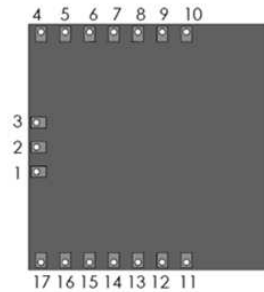

Figure 5: N5 M4 Bottom View

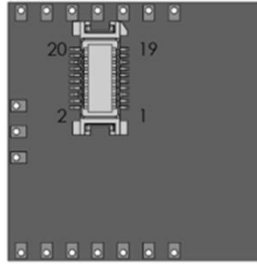

Figure 6: N5 M5 Module Bottom View

N5 M8 LGA Pad	N5 M4 Pin	N5 M5 Molex Connector	nRF51422 Pin Name	Description
A2-6	4	19	GND	Power supply ground
B1	2	10	RST /SWDIO	System reset. Also HW debug and flash programming I/O
B2			P018	GPIO
B3			P020	GPIO
B4			P019	GPIO
B5, B6	3	1	Vcc	Power supply source
C1	5	6	SWDCLK	HW debug and flash programming I/O
C2			P013	GPIO
C3			P016	GPIO
C4			P022	GPIO
C5, C6	3	1	Vcc	Power supply source
D1	12	3	P012	GPIO
D2	11	4	P015	GPIO
D3			P025	GPIO
D4	6	17	P023	GPIO
D5		16	P021	GPIO
D6	10	7	P024	GPIO
E1	14	9	P009	GPIO
E2	15	14	P011	GPIO
E3	13	5	P006	GPIO / ADC input 7/ ADC reference voltage 1
E4		20	P004	GPIO / ADC input 5
E5	9	11	P000	GPIO / ADC reference voltage 0
E6	8	13	P030	GPIO
F1	16	12	P008	GPIO
F2	17	2	P005	GPIO / ADC input 6
F3	1	8	P003	GPIO / ADC input 4
F4		18	P001	GPIO / ADC input 2
F5	7	15	P002	GPIO / ADC input 3
F6			P031	GPIO

Table 3: N5 ANT SoC Module Pin-Outs

2.3 N5 Module Preloaded Software

The N5 module is preloaded with the S210 SoftDevice, the ANT-WP bootloader, and the ANT Network Processor (NP) code as illustrated in Figure 7: Memory Map of the Preloaded Software. Depending on the module revision, the preloaded code varies. Please refer to Appendix C: N5 Module Pre-Loaded Software Versions.

- **S210 SoftDevice** - Refer to nRF51422 S210 SoftDevice Specification
- **ANT-WP Bootloader** - Refer to Appendix B: Using the ANT Bootloader for OTA Firmware Update
- **ANT Network Processor Application** - Refer to Appendix A: Using the ANT Network Processor Configuration

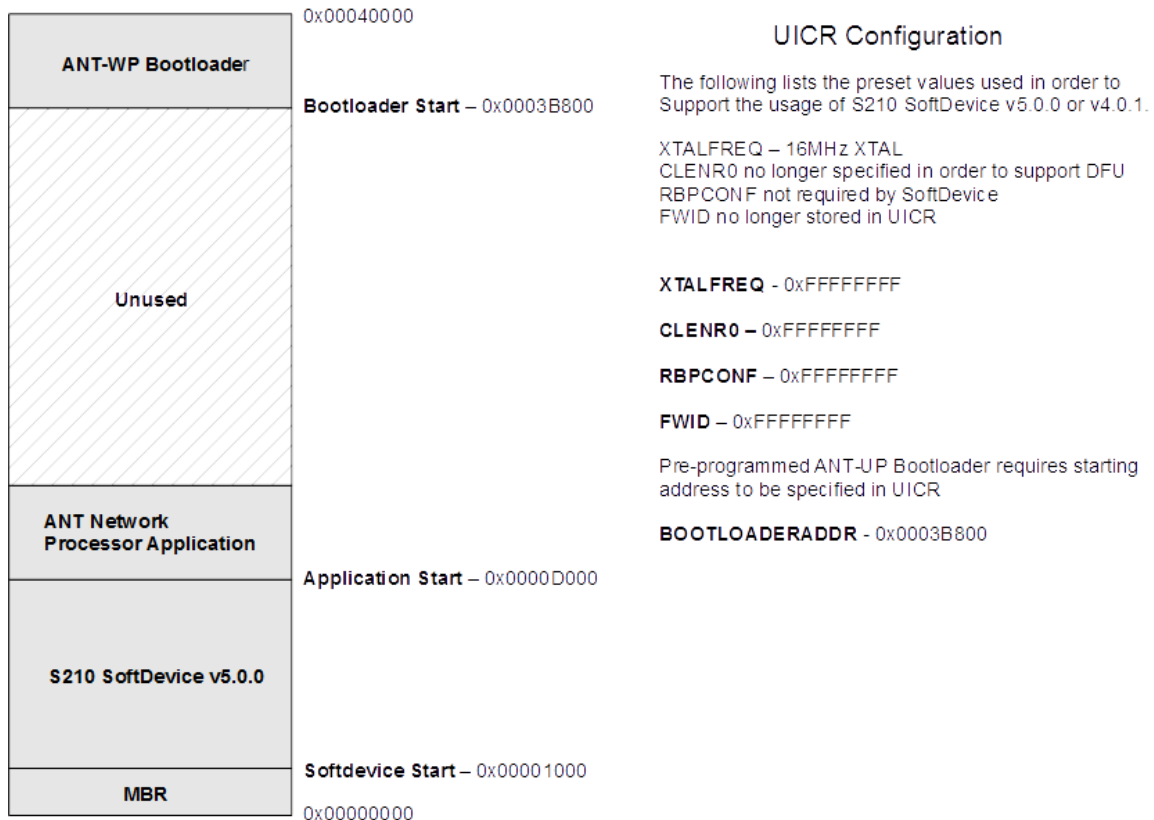

Figure 7: Memory Map of the Preloaded Software

2.4 N5 Module Programming

The N5 ANT SoC module series supports two programming methods:

- Standard Serial Wire Debug (SWD) interface
- Over-The-Air (OTA) updates using the preloaded ANT-WP bootloader (Not available for N548 Rev A)

These two programming methods are complementary. While the ANT-WP bootloader offers the convenience of programming wirelessly, it does consume some of the available application space. In case the space for the bootloader must be reclaimed for a large application, programming via SWD interface would be the option.

The three software components (the SoftDevice, the bootloader and the application code) must be version compatible to operate properly. Because each individual component can be reprogrammed, it is not safe to always assume the default factory image on a module by reading the module revision mark and referring to the history of

preloaded images as summarized in Appendix C: N5 Module Pre-Loaded Software Versions. When versions of the software components are unclear, to ensure proper operation after reprogramming, it is recommended that the module undergoes a full erasure (e.g. using the erase-all option in nrfjprog.exe/nRFgo Studio) and all desired software components be explicitly programmed onto the module.

Some reference application code is provided on <http://www.dynastream.com/N5starterkit>.

2.4.1 Programming via SWD Interface

The N5 ANT SoC Module series supports the Serial Wire Debug (SWD) interface SWDCLK and SWDIO (refer to Table 3). Programming and debugging of the module only require common available tools, such as the Keil software development environment and the Segger J-Link programmer.

Please refer to "[nRF51422 Evaluation Kit - Developing with the MDK-ARM Microcontroller Development Kit](#)" from Nordic Semiconductor for a specific reference on using the Keil software and J-Link programmer.

It is important to note that the BOOTLOADERADDR field in the UICR is set to the starting bootloader address location by default. If the desired programmed application needs to reclaim the bootloader region and/or if bootloader support is not required, then the BOOTLOADERADDR field in the UICR must be set to 0xFFFFFFFF. The erase-all command via nrfjprog.exe/nRFgo Studio should reset this field. Please refer to Figure 7: Memory Map of the Preloaded Software.

2.4.2 Programming Over the Air

The pre-programmed SoftDevice and ANT-WP bootloader in the N5 ANT SoC Module provides over-the-air firmware update capability. The pre-programmed ANT Network Processor Application provides two methods of entry into the bootloader mode in order to perform the software updates. SoftDevice, bootloader and application code in the module can be changed or updated in this manner.

Please refer to Appendix B: Using the ANT Bootloader for OTA Firmware Update.

2.4.3 Initializing the SoftDevice

The N5 module comes with 50ppm onboard 32 kHz crystal. When initializing the SoftDevice, it is important to set the crystal accuracy to be 50ppm. In the preloaded ANT Network Processor code, this line is used:

```
sd_softdevice_enable(NRF_CLOCK_LFCLKSRC_XTAL_50_PPM, softdevice_assert_callback)
```

2.4.4 Configuring the DC/DC Converter

The N5 module can make use of the DC/DC Converter on supported nRF51422 chip revisions. This can improve power consumption under certain conditions.

```
sd_softdevice_enable(NRF_CLOCK_LFCLKSRC_XTAL_50_PPM, softdevice_assert_callback)
```

2.5 Design Considerations

RF performance is always affected by the environment. Good design makes a product less susceptible. Guidelines provided in this section are for recommendations only. Users should thoroughly test their products in the intended use cases and make necessary modifications and trade-offs.

For design assistance purpose, a STEP model package of all the three module types and an Altium library of the M8 module are provided online.

2.5.1 M8 Module Mounting

Best RF performance is achieved by using 0.032" thickness FR4 under the module antenna and following the guideline on Figure 8.

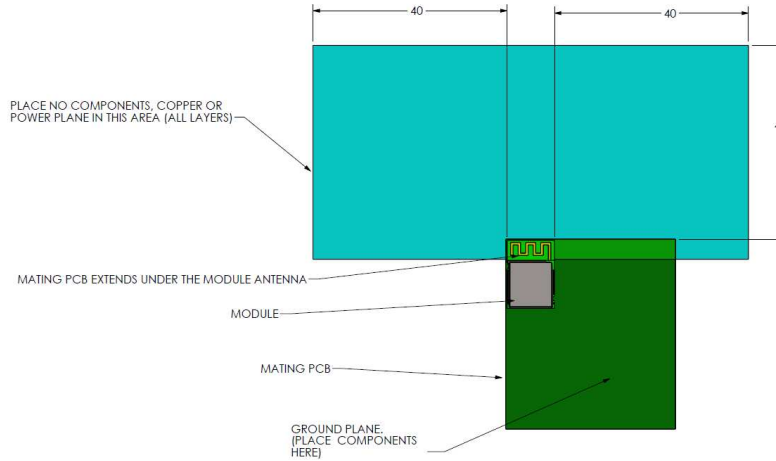

Figure 8: N5 M8 Module Mounting (all dimensions in mm)

2.5.2 M4 Module Mounting

Best possible RF performance is achieved when the module is placed such that the module antenna is protruding out from the mating PCB into free space as Figure 9. Place no exposed copper underneath the M4 module. If possible, place continuous ground plane under the module.

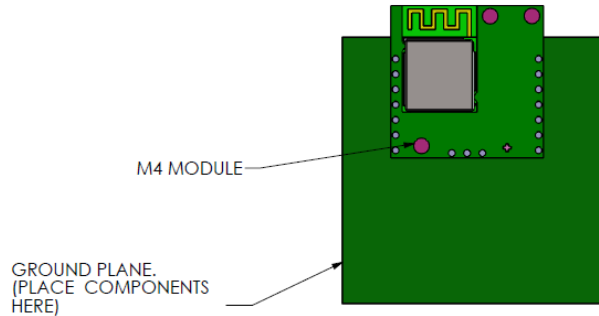

Figure 9: N5 M4 Module Mounting

2.5.3 M5 Module Mounting

The mating socket is Molex 52991-0208.

Note: The M5 module is provided for application prototyping and lab use. The M5 module should not be used to evaluate the RF performance of the N5 module family.

2.6 Assembly Considerations

2.6.1 Moisture Control

The moisture control of the module is rated at level 1 defined by IPC/JEDEC J-STD-020. The modules do not require special storage conditions provided:

- They are maintained at conditions equal to or less than 30 °C/85 % RH, and
- They are solder reflowed at a peak body temperature which does not exceed 260 °C

To ensure good solderability of the PCB pads, it is highly recommended to always have the modules intended for reflow well sealed when in storage.

2.6.2 Solder Stencil Design of M8 Module

The following reference stencil design is used to produce N5 M4 and M5 models.

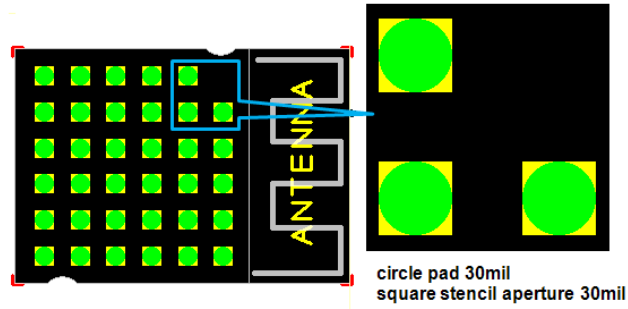

Figure 10: Solder Stencil Reference

2.6.3 Cleaning Process

The module is made using no-clean solder paste. No-clean process is recommended.

3 Regulatory Approvals and Compliances

The N5 ANT SoC module series, when loaded with ANT and/or BLUETOOTH low energy stack, has received regulatory approvals in the United States (FCC) and Canada (IC), and has been verified to conform to the appropriate regulations in Europe, Australia and New Zealand, and Japan. The module series has been qualified by BLUETOOTH SIG. Such approvals and qualification allow the user to place the module inside a finished product and, in most cases, not require regulatory testing for an intentional radiator, provided no changes or modifications are made to the module circuitry. This does not preclude the possibility that some other form of authorization or testing may be required for the finished product. Changes or modifications could void the user's authority to operate the equipment. The end user must comply with all of the instructions provided by the Grantee, which indicate installation and/or operating conditions necessary for compliance.

3.1 United States

The N5 ANT SoC module series has been tested and found to comply with the limits for a Class B digital device, pursuant to Part 15 of the FCC Rules. These limits are designed to provide reasonable protection against harmful interference in a residential installation. This equipment generates, uses, and can radiate radio frequency energy and, if not installed and used in accordance with the instructions, may cause harmful interference to radio communications. However, there is no guarantee that interference will not occur in a particular installation. If this equipment does cause harmful interference to radio or television reception, which can be determined by turning the equipment off and on, the user is encouraged to try to correct the interference by one of the following measures:

- Reorient or relocate the receiving antenna.
- Increase the separation between the equipment and receiver.
- Connect the equipment into an outlet on a circuit different from that to which the receiver is connected.
- Consult the dealer or an experienced radio/TV technician for help.

The N5 module series complies with Part 15 of the FCC Rules. Operation is subject to the following two conditions: (1) This device may not cause harmful interference, and (2) this device must accept any interference received, including interference that may cause undesired operation.

The N5 module series does not contain any user-serviceable parts. Unauthorized repairs or modifications could result in permanent damage to the equipment, and void your warranty and your authority to operate this device under Part 15 regulations.

The N5 module series is labelled with its own FCC ID, O6R2398 (note: First Character is the letter O, not the # 0.) If the FCC ID is not visible when the module is installed inside another device, then the outside of the device into which the module is installed must also display a label referring to the enclosed module. This exterior label can use wording such as the following: "Contains Transmitter Module FCC ID: O6R2398" or "Contains FCC ID: O6R2398". Any similar wording that expresses the same meaning may be used.

3.2 Canada

The N5 ANT SoC module series complies with Industry Canada licence-exempt RSS standard(s). Operation is subject to the following two conditions: (1) this device may not cause interference, and (2) this device must accept any interference, including interference that may cause undesired operation of the device.

(Le présent appareil est conforme aux CNR d'Industrie Canada applicables aux appareils radio exempts de licence. L'exploitation est autorisée aux deux conditions suivantes: (1) l'appareil ne doit pas produire de brouillage, et (2) l'utilisateur de l'appareil doit accepter tout brouillage radioélectrique subi, même si le brouillage est susceptible d'en compromettre le fonctionnement.)

To comply with Industry Canada regulations, it is required that product containing the N5 module series display a label referring to the enclosed module. This exterior label can use wording similar to the following: "Contains IC: 3797A-2398"

This information shall be affixed in such a manner as not to be removable except by destruction or defacement. The size of the lettering shall be legible without the aid of magnification but is not required to be larger than 8-point font size. If the device is too small to meet this condition, the information can be included in the user manual upon agreement with Industry Canada.

3.3 European Economic Area



The N5 ANT SoC module series is declared to be in conformance with the essential requirements and other relevant provisions of Directive 1999/5/EC, as a low-powered unlicensed transmitter:

- IEC 60950-1:2005 (2nd Edition)+Am 1:2009+Am 2:2013, EN 60950-1:2006+A11:2009+A1:2010+A12:2011+A2:2013 Information technology equipment - Safety - Part 1: General requirements
- EN 300 440-2 v1.4.1 Electromagnetic compatibility and Radio spectrum Matters (ERM); Short range devices; Radio equipment to be used in the 1 GHz to 40 GHz frequency range
- EN 300 328 v1.9.1 Electromagnetic compatibility and Radio spectrum Matters (ERM); Wideband transmission systems; Data transmission equipment operating in the 2,4 GHz ISM band and using wide band modulation techniques; Harmonized EN covering the essential requirements of article 3.2 of the R&TTE Directive
- EN 301 489-3 v1.6.1 Electromagnetic compatibility and Radio spectrum Matters (ERM); Electromagnetic Compatibility (EMC); standard for radio equipment and services; Part 3: Specific conditions for Short-Range Devices (SRD) operating on frequencies between 9 kHz and 40 GHz
- EN 301 489-17 v2.2.1 Electromagnetic compatibility and Radio spectrum Matters (ERM); Electromagnetic Compatibility (EMC); standard for radio equipment and services; Part 17: Specific conditions for Broadband Data Transmissions

3.4 Australia & New Zealand



The N5 ANT SoC module series has been tested and found to comply with

- AS/NZS 4268:2012 + A1:2013 Radio equipment and systems – Short range devices – Limits and methods of measurement
- AS/NZS CISPR 22:2009 + A1:2010 Information technology equipment - Radio disturbance characteristics - Limits and methods of measurement
-

The ACMA supplier code number is N20233

3.5 Japan

The N548, N550 and N5150 models have been granted type certificate (mark number R203-JN6049). Standard applied:

Notification No. 88 of MIC 2004, 2.4GHz band wide-band low-power data communication system (item 19 of Article 2 paragraph 1)

3.6 BLUETOOTH Qualification

The N5 ANT SoC module series is listed as a Bluetooth End Product on the Bluetooth SIG Qualified Design List [Qualified Design ID 54799; Declaration ID is D022375]. Further use of this design to create subsequent BLUETOOTH implementations can be achieved without further qualification provided that the resulting implementation has no negative material impact on the BLUETOOTH performance or functionality of the design.

4 Electrical Specifications

4.1 Absolute Maximum Ratings

PARAMETER	TEST CONDITIONS	Min	Max	Unit
Supply voltage (VCC)	All supply pins must have the same voltage	-0.3	3.9	V
Voltage on any digital pin		-0.3	VCC+0.3, ≤ 3.9	V
Storage temperature range		-40	125	°C
ESD	All pads, according to human-body model, JEDEC STD 22, method A114		4	kV
	According to charged-device model, JEDEC STD 22, method C101		500	V

Table 4: Absolute Maximum Ratings

Stresses beyond those listed under Absolute Maximum Ratings may cause permanent damage to the device. These are stress ratings only and functional operation of the device at these or any other conditions beyond those indicated under Recommended Operating Conditions are not implied. Exposure to absolute-maximum-rated conditions for extended periods may affect device reliability.

4.2 Recommended Operating Conditions

PARAMETER	Min	Max	Unit
Operating ambient temperature range, T _A	-25	+75	°C
Operating supply voltage	1.8	3.6	V

Table 5: Recommended Operating Conditions

4.3 Industrial Temperature Range

The N550 modules are able to operate from -40°C to +85°C when the supply voltage is from 1.9V to 3.6V. For details, please refer to “nRF51422 Specification for Industrial Temperature Range” from Nordic Semiconductor.

4.4 Radio Operation Specifications and Antenna Characteristics

nRF5142 Output Setting (dBm)	Peak Antenna Gain (dBi)	EIRP (dBm)
0	0	0
+4	0	+4

Table 6: N5 Module Antenna Gain

nRF51422 Output Setting (dBm)	Typical Radio current (mA)*
0	10.5
+4	16.0

Table 7: Current Consumption of Radio Operation

* Note: For additional information regarding radio current, please refer to the nRF51422 product specification by Nordic Semiconductor.

The following typical radiation pattern is recorded in an anechoic chamber at 2440MHz and 0dBm output following the recommended mounting guideline.

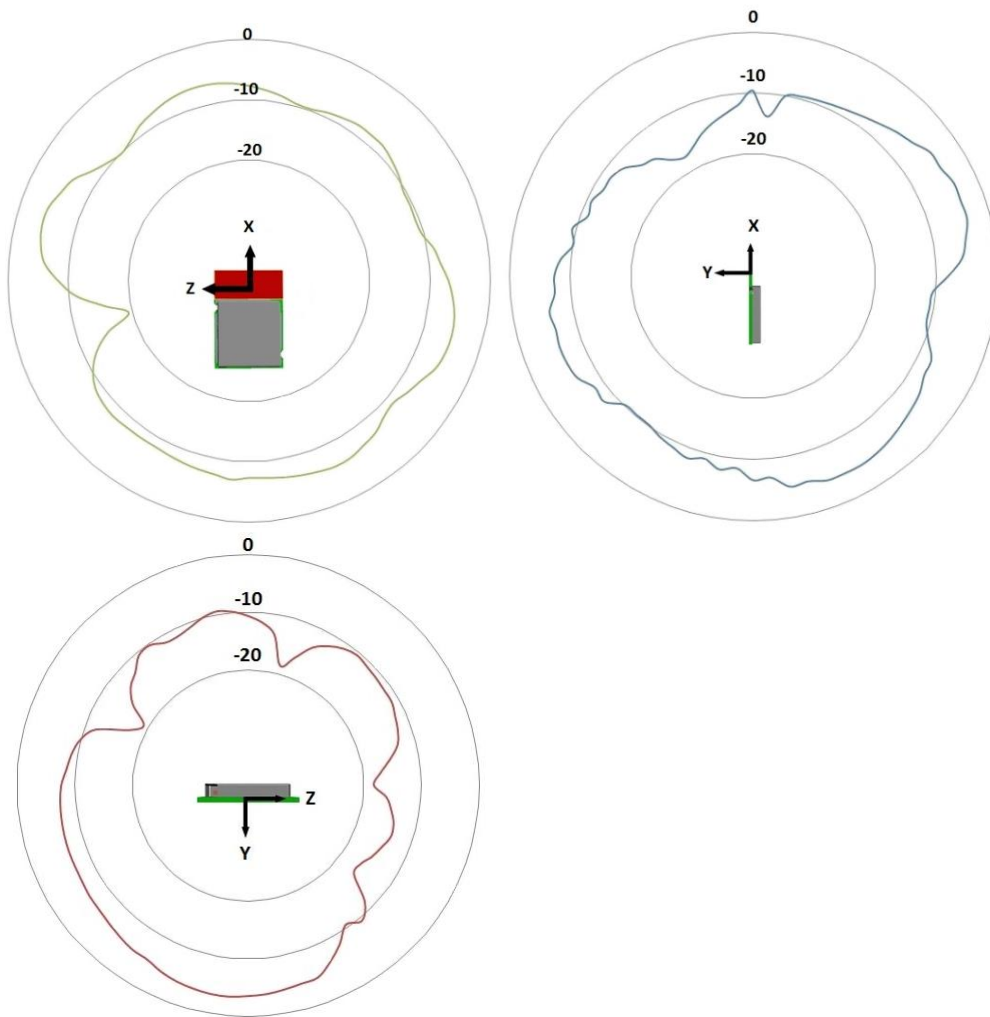

Figure 11: N5 M4 Module Typical Antenna Gain (dBi)

To understand and properly use the radiation pattern for your design, please refer to the application note: Interpreting RF Radiation Patterns.

4.5 Electrical Specifications

Please refer to the nRF51422 Product Specification by Nordic Semiconductor.

5 Mechanical Drawings

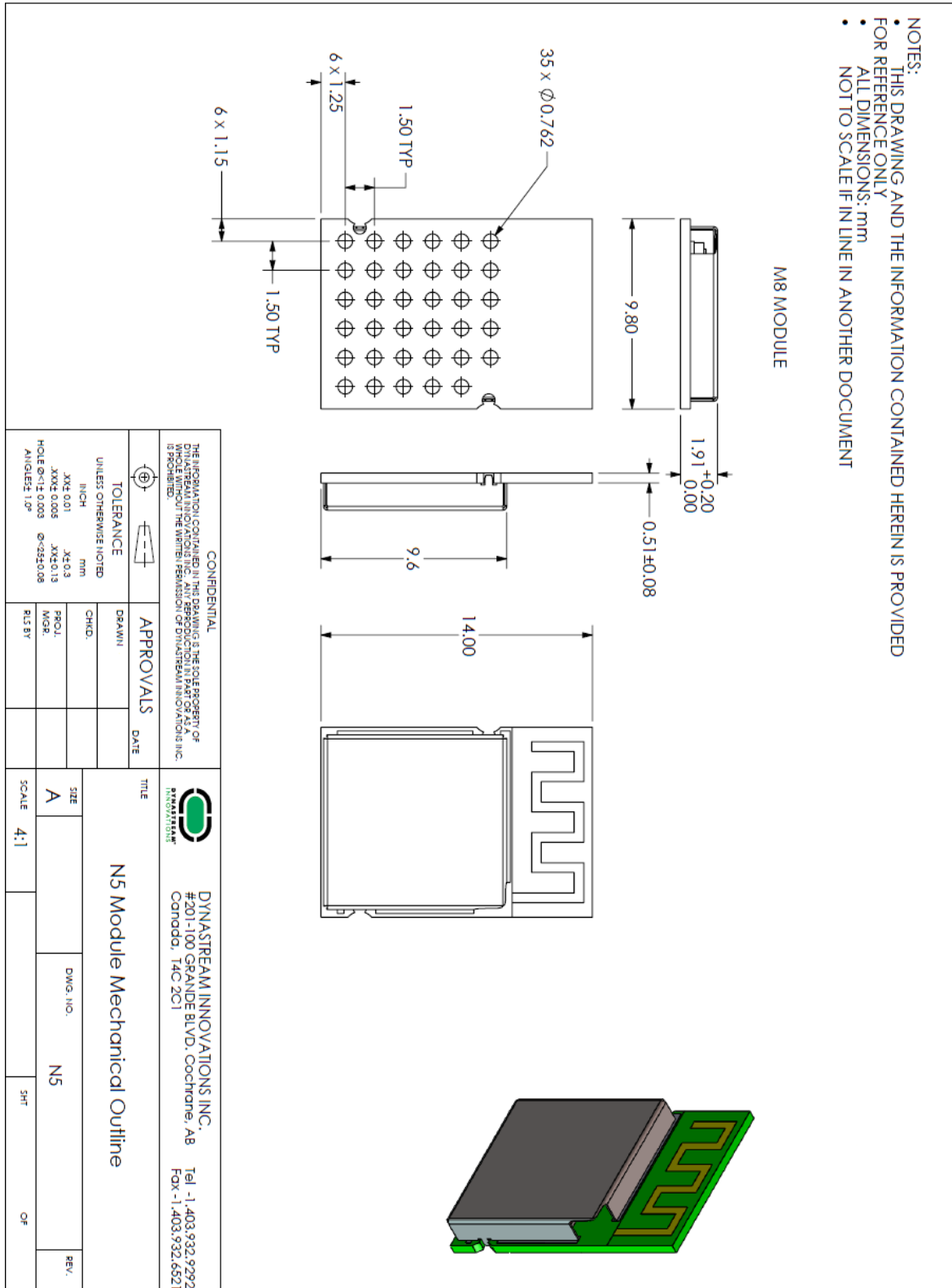

Figure 12: N5 M8 Mechanical Drawing

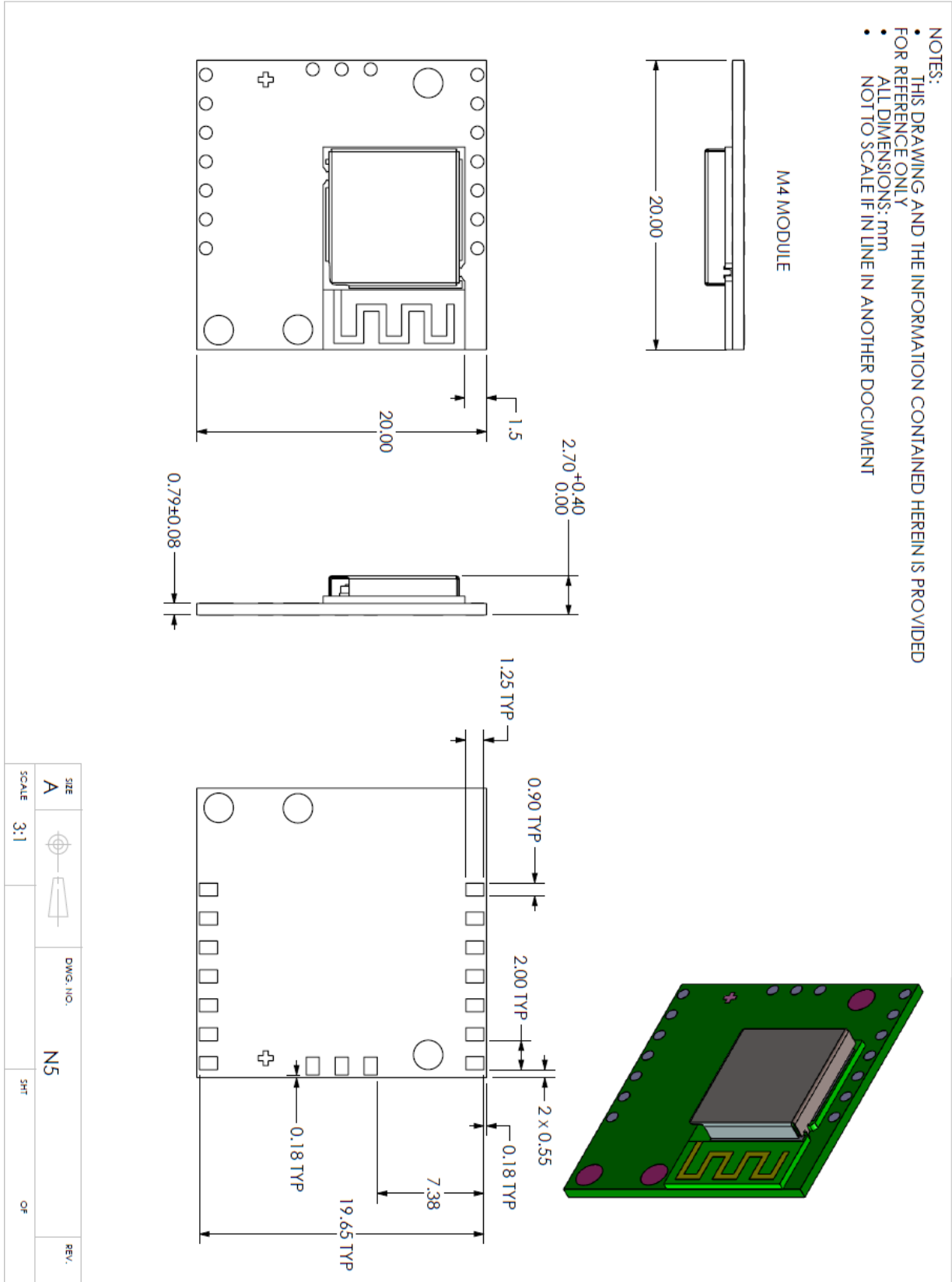

Figure 13: N5 M4 Mechanical Drawing

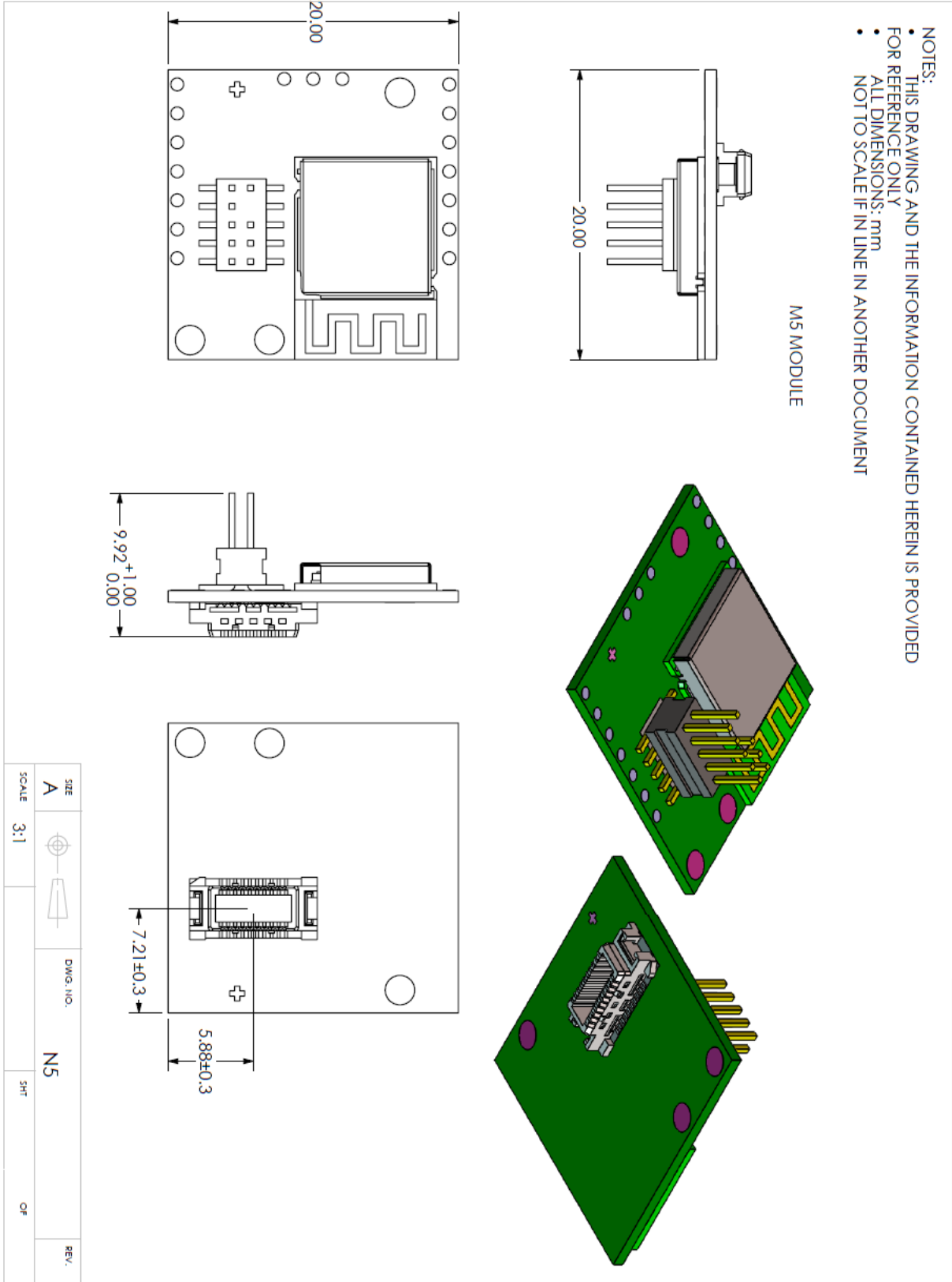

Figure 14: N5 M5 Mechanical Drawing

6 Support

The N5 ANT SoC module series uses nRF51422 from Nordic Semiconductor. Users can seek technical support from Nordic Semiconductor, www.nordicsemi.com. Users can seek application support from Dynastream Innovations, www.thisisant.com.

6.1 ANT Forum

Users are encouraged to participate in the ANT forum moderated by the application engineering team of Dynastream Innovations for any engineering discussions. Joining the ANT forum is free and open at <http://www.thisisant.com/forum>.

6.2 Technical References

Documents:

1. nRF51422 Product Specification, Nordic semiconductor
2. nRF51422 Specification for Industrial Temperature Range, Nordic Semiconductor
3. nRF51 Series Compatibility Matrix, Nordic Semiconductor
4. nRF51822 and nRF51422 Product Anomaly Notification (PAN-028), Nordic Semiconductor
5. nRF51 Series Reference Manual, Nordic Semiconductor
6. nRF51422 S210 SoftDevice Specification, Nordic Semiconductor
7. nRF51422 S310 SoftDevice Specification, Nordic Semiconductor
8. nRF51822 S110 SoftDevice Specification, Nordic Semiconductor
9. nRF51822 S120 SoftDevice Specification, Nordic Semiconductor
10. S130 nRF51822 SoftDevice Specification, Nordic Semiconductor
11. nRF51422 Evaluation Kit - Developing with the MDK-ARM Microcontroller Development Kit, Nordic Semiconductor
12. N5 Starter Kit User Manual, Dynastream Innovations
13. ANT Message Protocol and Usage, Dynastream Innovations
14. Interfacing with ANT General Purpose Chipsets and Modules, Dynastream Innovations
15. ANT-FS Technical Specification, Dynastream Innovations
16. Application Note: Interpreting RF Radiation Patterns, Dynastream Innovations
17. Application Note: Over the Air Firmware Updates Using ANT-FS, Dynastream Innovations

Software:

18. S210 nRF51422 SoftDevice, Nordic Semiconductor
19. S310 nRF51422 SoftDevice, Nordic Semiconductor
20. S110 nRF51822 SoftDevice, Nordic Semiconductor
21. S120 nRF51822 SoftDevice, Nordic Semiconductor
22. S130 nRF51822 SoftDevice, Nordic Semiconductor
23. N5 Starter Kit SDK, Dynastream Innovations
24. N5 Starter Kit ANT IO Demo, Dynastream Innovations
25. OTA Updater – a wireless firmware update tool, Dynastream Innovations
26. ANTwareII – a system testing and debugging tool, Dynastream Innovations
27. ObservANT – an ANT debugging tool, Dynastream Innovations

Design models:

28. N5 M8 Altium library, Dynastream Innovations
29. N5 module STEP mode, Dynastream Innovations

The above documents and software are available at www.dynastream.com, www.thisisant.com and/or www.nordicsemi.com. User registration or supplier product code may be required.

6.3 ANT Developer's Zone

ANT development software tools, application notes, reference designs and other public resources are found in the ANT Developer's Zone at <http://www.thisisant.com/developer>.

To begin development with the ANT+ interoperability, please become an [ANT+ Adopter or ANT+ Alliance member](#) to obtain the access to the ANT+ Adopter Zone. ANT+ documents and design tools contained in the ANT+

Adopter zone include the ANT+ Device Profiles, ANT-FS specification, ANT software (PC/Mac) libraries with source code, simulator tools (SimulANT+), embedded reference designs with source code, and more.

6.4 ANT and ANT+ Social Media

ANT is on the following social media sites,

YouTube: <http://www.youtube.com/user/ANTAlliance>

Twitter: <http://twitter.com/ANTPlus>

Facebook: <https://www.facebook.com/thisisant>

LinkedIn: <http://www.linkedin.com/groups?gid=1379137>