



Chipsmall Limited consists of a professional team with an average of over 10 year of expertise in the distribution of electronic components. Based in Hongkong, we have already established firm and mutual-benefit business relationships with customers from,Europe,America and south Asia,supplying obsolete and hard-to-find components to meet their specific needs.

With the principle of “Quality Parts,Customers Priority,Honest Operation,and Considerate Service”,our business mainly focus on the distribution of electronic components. Line cards we deal with include Microchip,ALPS,ROHM,Xilinx,Pulse,ON,Everlight and Freescale. Main products comprise IC,Modules,Potentiometer,IC Socket,Relay,Connector.Our parts cover such applications as commercial,industrial, and automotives areas.

We are looking forward to setting up business relationship with you and hope to provide you with the best service and solution. Let us make a better world for our industry!



Contact us

Tel: +86-755-8981 8866 Fax: +86-755-8427 6832

Email & Skype: info@chipsmall.com Web: www.chipsmall.com

Address: A1208, Overseas Decoration Building, #122 Zhenhua RD., Futian, Shenzhen, China



Compact Size Picking Sensor NA1-PK3 SERIES

Related Information

- General terms and conditions..... F-7
- Sensor selection guide P.461~
- Glossary of terms..... P.1455~
- General precautions.....P.1458~

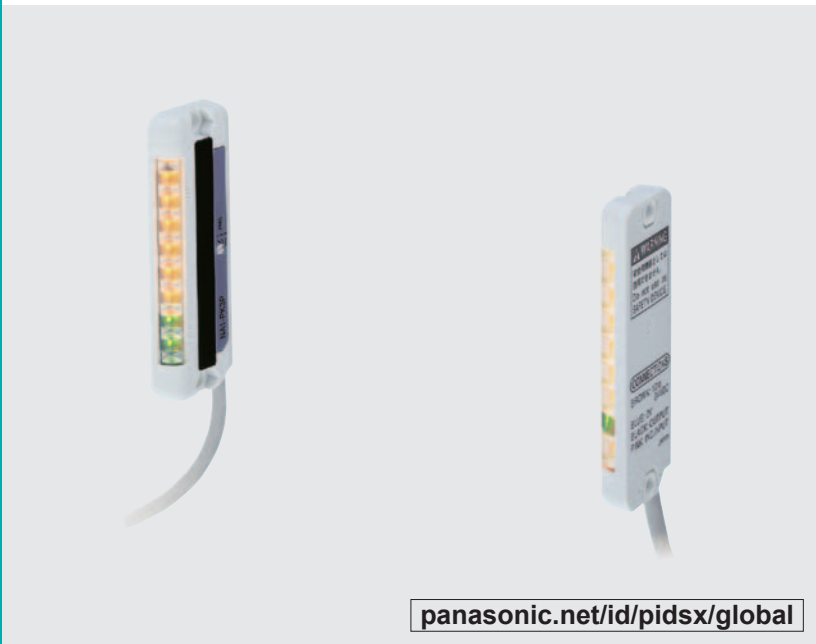

panasonic.net/id/pidsx/global



Make sure to use light curtains when using a sensing device for personnel protection. Refer to p.495~ for details of light curtains.



Boasts a compact, pocket lighter size enabling universal installation

Space-saving, pocket lighter-sized unit

Ultra compact size: W24 × H70 × D8 mm **W0.945 × H2.756 × D0.315 in.**
Can even be mounted within the small space constraints of parts containers.



NA1-PK3 Pocket lighter

Utilizes a large, bright, clearly visible job indicator

The ultra compact body incorporates a job indicator approx. 50 mm **1.969 in** tall. Due to its brightness and high visibility, it is now possible to check sensor operation even from a distance.



- FIBER SENSORS
- LASER SENSORS
- PHOTOELECTRIC SENSORS
- MICRO PHOTOELECTRIC SENSORS
- AREA SENSORS**
- LIGHT CURTAINS / SAFETY COMPONENTS
- PRESSURE / FLOW SENSORS
- INDUCTIVE PROXIMITY SENSORS
- PARTICULAR USE SENSORS
- SENSOR OPTIONS
- SIMPLE WIRE-SAVING UNITS
- WIRE-SAVING SYSTEMS
- MEASUREMENT SENSORS
- STATIC ELECTRICITY PREVENTION DEVICES
- LASER MARKERS
- PLC
- HUMAN MACHINE INTERFACES
- ENERGY CONSUMPTION VISUALIZATION COMPONENTS
- FA COMPONENTS
- MACHINE VISION SYSTEMS
- UV CURING SYSTEMS

- Selection Guide
- Slim Body
- Picking
- Other Products

- NA1-PK5/
NA1-5
- NA1-PK3**

APPLICATIONS**Cell production line****Assembly line****BASIC PERFORMANCE****No synchronization wires required**

Synchronization wires are not required, due to the utilization of a synchronized scanning system that results in a reduction of wiring man-hours. In addition, the sensors can be switched among three different emission frequencies, allowing up to three sets of sensors to be installed closely together in the same vertical plane, without causing mutual interference. Even when installed in multistage shelving, malfunctions due to mutual interference will not occur. (When mounted horizontally, a maximum of two sensor sets may be used side-by-side, without interference.)

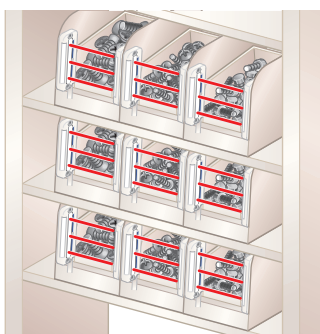
**FUNCTIONS****Switchable output operation**

Output operation can be switched to suit the desired application.

OPTIONS**Sensor protection brackets are available**

Sensor protection brackets are now available (optional), to protect sensors from damage due to tools and other objects. The protection brackets have a black coating, which enhances the visual effectiveness of the job indicator.

**MOUNTING****Easy alignment**

The sensor's beam axis is directly in line with the mounting holes, making sensor alignment easier. Mounting can be performed simply by using M4 nuts.

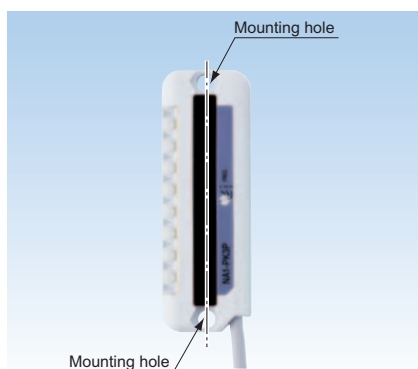
**Flexible cable orientation**

The cabling can be oriented in either of the two different directions: downward or sideways, thus permitting a flexible layout, in accordance with the sensor's mounting position.

FIBER
SENSORSLASER
SENSORSPHOTOELECTRIC
SENSORSMICRO
PHOTOELECTRIC
SENSORS**AREA
SENSORS**LIGHT CURTAINS /
SAFETY
COMPONENTSPRESSURE /
FLOW
SENSORSINDUCTIVE
PROXIMITY
SENSORSPARTICULAR
USE SENSORSSENSOR
OPTIONSSIMPLE
WIRE-SAVING
UNITSWIRE-SAVING
SYSTEMSMEASUREMENT
SENSORSSTATIC ELECTRICITY
PREVENTION
DEVICESLASER
MARKERS

PLC

HUMAN MACHINE
INTERFACESENERGY CONSUMPTION
VISUALIZATION
COMPONENTS

FA COMPONENTS

MACHINE VISION
SYSTEMSUV CURING
SYSTEMSSelection
Guide

Slim Body

Picking

Other Products

**NA1-PK5/
NA1-5****NA1-PK3**

- FIBER SENSORS
- LASER SENSORS
- PHOTO-ELECTRIC SENSORS
- MICRO PHOTO-ELECTRIC SENSORS
- AREA SENSORS
- LIGHT CURTAINS/ SAFETY COMPONENTS
- PRESSURE / FLOW SENSORS
- INDUCTIVE PROXIMITY SENSORS
- PARTICULAR USE SENSORS
- SENSOR OPTIONS
- SIMPLE WIRE-SAVING UNITS
- WIRE-SAVING SYSTEMS
- MEASUREMENT SENSORS
- STATIC ELECTRICITY PREVENTION DEVICES
- LASER MARKERS
- PLC
- HUMAN MACHINE INTERFACES
- ENERGY CONSUMPTION VISUALIZATION COMPONENTS
- FA COMPONENTS
- MACHINE VISION SYSTEMS
- UV CURING SYSTEMS
- Selection Guide
- Slim Body
- Picking
- Other Products
- NA1-PK5/ NA1-5
- NA1-PK3

ORDER GUIDE

Type	Appearance	Sensing range (Note 1)	Model No. (Note 2)	Output
NPN output			NA1-PK3	NPN open-collector transistor
PNP output			NA1-PK3-PN	PNP open-collector transistor

Notes: 1) The sensing range is the possible setting distance between the emitter and the receiver.

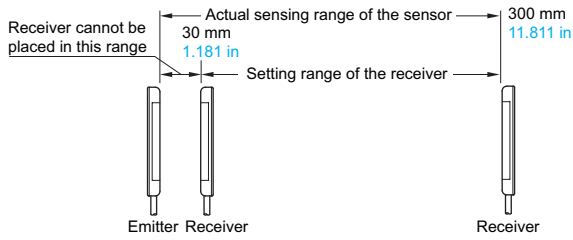

2) The model No. with "P" shown on the label affixed to the product is the emitter, "D" shown on the label is the receiver.

5 m 16.404 ft cable length type, pigtailed type

5 m 16.404 ft cable length type (standard: 2 m 6.562 ft) and pigtailed type (standard: cable type) are also available.

Table of Model Nos.

Type	Standard type	5 m 16.404 ft cable length type	Pigtailed type (Note)
NPN output	NA1-PK3	NA1-PK3-C5	NA1-PK3-J
PNP output	NA1-PK3-PN	NA1-PK3-PN-C5	NA1-PK3-PN-J

Note: Please order the suitable mating cable separately for pigtailed type.

Mating cable (2 cables are required.)

Model No.	Description
CN-24-C2	4-core, cable length 2 m 6.562 ft
CN-24-C5	4-core, cable length 5 m 16.404 ft

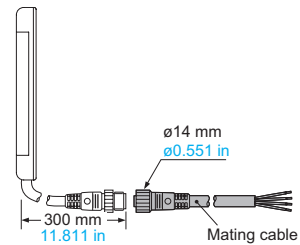

OPTIONS

Designation	Model No.	Description
Sensor protection bracket	MS-NA3-3	It protects the sensor body. Two black bracket set [Four M4 (length 15 mm 0.591 in) screws with washers, and four nuts are attached.]
Y-shaped connector	SL-WY 5 pcs. per set	This connector is able to combine the cables of receiver and emitter into one.

Sensor protection bracket

MS-NA3-3

Two bracket set
[Four M4 (length 15 mm 0.591 in) screws with washers, and four nuts are attached.]

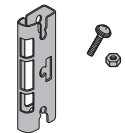

Y-shaped connector

SL-WY

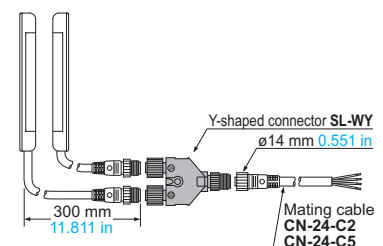

SPECIFICATIONS

Item	Type	NPN output	PNP output
	Model No.	NA1-PK3	NA1-PK3-PN
Sensing height		49.2 mm 1.937 in	
Sensing range (Note 2)		30 to 300 mm 1.181 to 11.811 in	
Beam pitch		24.6 mm 0.969 in	
Number of beam channels		3 beam channels	
Sensing object		ø29 mm ø1.142 in or more opaque object (completely beam interrupted object)	
Supply voltage		12 to 24 V DC ±10 % Ripple P-P 10 % or less	
Current consumption		Emitter: 30 mA or less, Receiver: 50 mA or less	
Output		NPN open-collector transistor <ul style="list-style-type: none"> • Maximum sink current: 100 mA • Applied voltage: 30 V DC or less (between output and 0 V) • Residual voltage: 1 V or less (at 100 mA sink current) 0.4 V or less (at 16 mA sink current) 	PNP open-collector transistor <ul style="list-style-type: none"> • Maximum source current: 100 mA • Applied voltage: 30 V DC or less (between output and +V) • Residual voltage: 1 V or less (at 100 mA source current) 0.4 V or less (at 16 mA source current)
	Utilization category	DC-12 or DC-13	
	Output operation	ON or OFF when one or more beam channels are interrupted, selectable by operation mode switch	
	Short-circuit protection	Incorporated	
Response time		10 ms or less (when interference prevention function is used: 30 ms or less)	
Indicators	Emitter	Power indicator: Green LED (lights up when the power is ON) Job indicator: Orange LED (lights up when the job indicator input is Low)	Power indicator: Green LED (lights up when the power is ON) Job indicator: Orange LED (lights up when the job indicator input is High)
	Receiver	Operation indicator: Red LED (lights up when the output is ON) Stable incident beam indicator: Green LED (lights up when all beam channels are stably received) Job indicator: Orange LED (lights up when the job indicator input is Low)	Operation indicator: Red LED (lights up when the output is ON) Stable incident beam indicator: Green LED (lights up when all beam channels are stably received) Job indicator: Orange LED (lights up when the job indicator input is High)
Interference prevention function		Incorporated (Up to 3 units can be mounted close together.) (Note 3)	
Environmental resistance	Pollution degree	3 (Industrial environment)	
	Protection	IP62 (IEC)	
	Ambient temperature	-10 to +55 °C +14 to +131 °F (No dew condensation or icing allowed), Storage: -20 to +70 °C -4 to +158 °F	
	Ambient humidity	35 to 85 % RH, Storage: 35 to 85 % RH	
	Ambient illuminance	Incandescent light: 3,000 lx at the light-receiving face	
	EMC	EN 60947-5-2	
	Voltage withstandability	1,000 V AC for one min. between all supply terminals connected together and enclosure	
	Insulation resistance	20 MΩ, or more, with 250 V DC megger between all supply terminals connected together and enclosure	
	Vibration resistance	10 to 150 Hz frequency, 0.75 mm 0.030 in (5 G max.) amplitude in X, Y and Z directions for two hours each	
Shock resistance	500 m/s ² acceleration (50 G approx.) in X, Y and Z directions for three times each		
Emitting element		Infrared LED (synchronized scanning system)	
Material		Enclosure: Heat-resistant ABS, Lens cover: Acrylic, Indicator cover: Acrylic	
Cable		0.2 mm ² 4-core (emitter: 3-core) oil resistant cabtyre cable, 2 m 6.562 ft long	
Cable extension		Extension up to total 100 m 328.084 ft is possible for both emitter and receiver with 0.3 mm ² , or more, cable.	
Net weight		Emitter: 50 g approx., Receiver: 50 g approx.	

Notes: 1) Where measurement conditions have not been specified precisely, the conditions used were an ambient temperature of +23 °C **+73.4 °F**.
2) The sensing range is the possible setting distance between the emitter and the receiver.

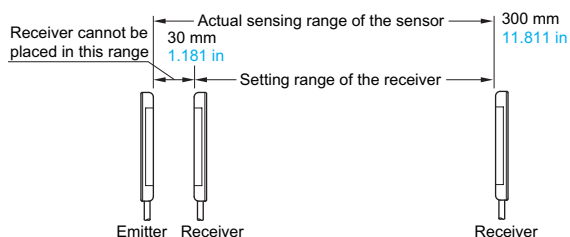

3) For more details, refer to the "Interference prevention function (p.488)" in "PRECAUTIONS FOR PROPER USE".

FIBER SENSORS

LASER SENSORS

PHOTO-ELECTRIC SENSORS

MICRO PHOTO-ELECTRIC SENSORS

AREA SENSORS

LIGHT CURTAINS / SAFETY COMPONENTS

PRESSURE / FLOW SENSORS

INDUCTIVE PROXIMITY SENSORS

PARTICULAR USE SENSORS

SENSOR OPTIONS

SIMPLE WIRE-SAVING UNITS

WIRE-SAVING SYSTEMS

MEASUREMENT SENSORS

STATIC ELECTRICITY PREVENTION DEVICES

LASER MARKERS

PLC

HUMAN MACHINE INTERFACES

ENERGY CONSUMPTION VISUALIZATION COMPONENTS

FA COMPONENTS

MACHINE VISION SYSTEMS

UV CURING SYSTEMS

Selection Guide

Slim Body

Picking

Other Products

NA1-PK5/NA1-5

NA1-PK3

- FIBER SENSORS
- LASER SENSORS
- PHOTO-ELECTRIC SENSORS
- MICRO PHOTO-ELECTRIC SENSORS
- AREA SENSORS
- LIGHT CURTAINS/ SAFETY COMPONENTS
- PRESSURE / FLOW SENSORS
- INDUCTIVE PROXIMITY SENSORS
- PARTICULAR USE SENSORS
- SENSOR OPTIONS
- SIMPLE WIRE-SAVING UNITS
- WIRE-SAVING SYSTEMS
- MEASUREMENT SENSORS
- STATIC ELECTRICITY PREVENTION DEVICES
- LASER MARKERS
- PLC
- HUMAN MACHINE INTERFACES
- ENERGY CONSUMPTION VISUALIZATION COMPONENTS
- FA COMPONENTS
- MACHINE VISION SYSTEMS
- UV CURING SYSTEMS

I/O CIRCUIT AND WIRING DIAGRAMS

NPN output type

I/O circuit diagram

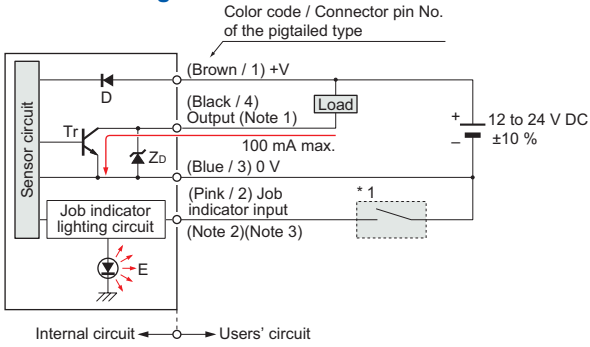

Symbols...D : Reserve supply polarity protection diode
Zd: Surge absorption zener diode
Tr: NPN output transistor
E : Job indicator (IND.)

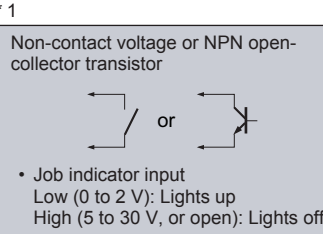

Connector pin position (Pigtailed type)

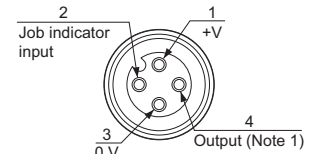

Notes: 1) No connection is required for the emitter.
2) The pin position for the **SL-WY** Y-shaped connector (optional) is identical to the receiver.

Notes: 1) The emitter does not incorporate the output (black).
2) If a mating cable is connected to the pigtailed type, then the lead wire color is "white".
3) When the job indicator is used as a large size operation indicator, connect the job indicator input wire (pink) of the emitter and the receiver to the output wire (black) of the receiver.

PNP output type

I/O circuit diagram

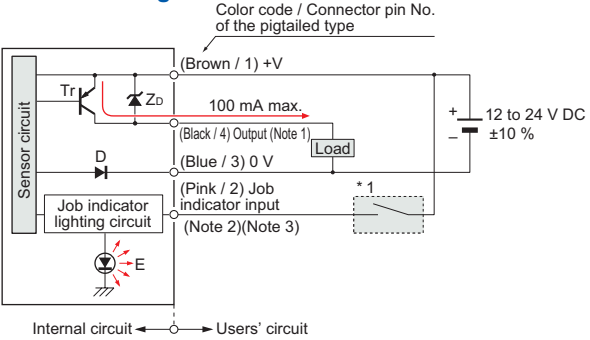

Symbols...D : Reserve supply polarity protection diode
Zd: Surge absorption zener diode
Tr: PNP output transistor
E : Job indicator (IND.)

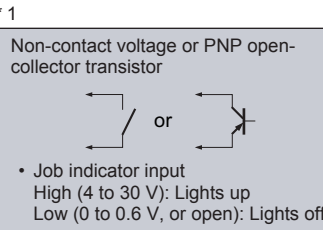

Connector pin position (Pigtailed type)

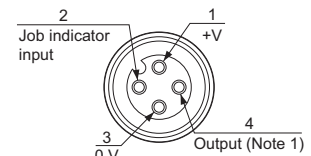

Notes: 1) No connection is required for the emitter.
2) The pin position for the **SL-WY** Y-shaped connector (optional) is identical to the receiver.

Notes: 1) The emitter does not incorporate the output (black).
2) If a mating cable is connected to the pigtailed type, then the lead wire color is "white".
3) When the job indicator is used as a large size operation indicator, connect the job indicator input wire (pink) of the emitter and the receiver to the output wire (black) of the receiver.

SENSING CHARACTERISTICS (TYPICAL)

Parallel deviation

Vertical direction

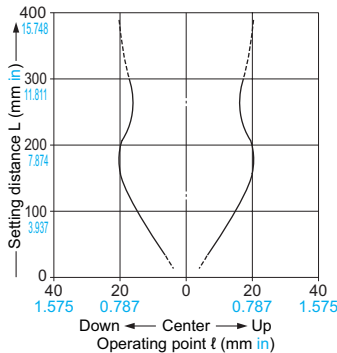
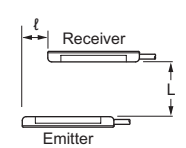

Horizontal direction

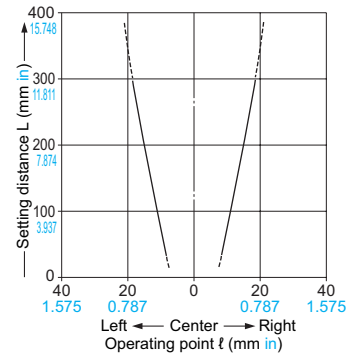
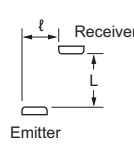

Angular deviation

Vertical direction emitter angular deviation

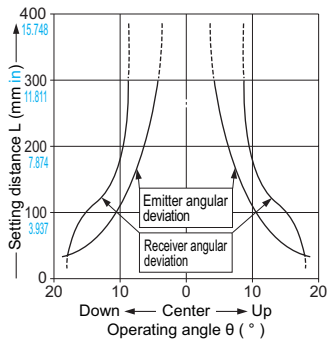
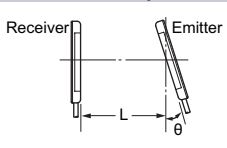

Horizontal direction emitter angular deviation

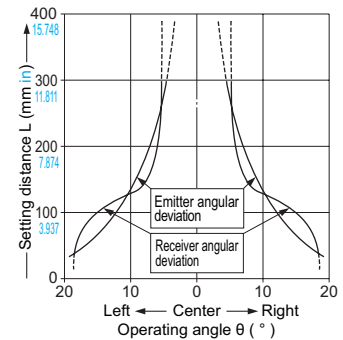
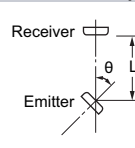

Vertical direction receiver angular deviation

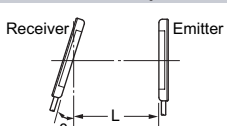

Horizontal direction receiver angular deviation

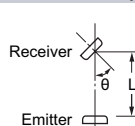

- Selection Guide
- Slim Body
- Picking
- Other Products
- NA1-PK5/ NA1-5
- NA1-PK3

PRECAUTIONS FOR PROPER USE

Refer to p.1458~ for general precautions.



- Never use this product as a sensing device for personnel protection.
- For sensing devices to be used as safety devices for press machines or for personnel protection, use products which meet standards, such as OSHA, ANSI or IEC etc., for personnel protection applicable in each region or country.
- If this product is used as a sensing device for personnel protection, death or serious body injury could result.
- For a product which meets safety standards, use the following products.
Type 4: **SF4C** series (p.531~)
Type 2: **SF2C** series (p.551~)

Part description

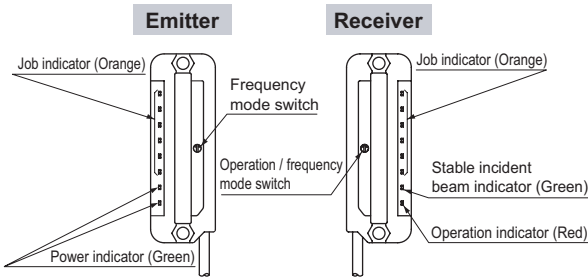

Mounting

- Use M4 screws with washers and M4 nuts. The tightening torque should be 0.5 N·m or less. (Purchase the screws and nuts separately.)

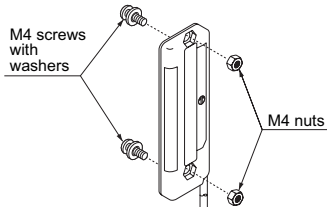

Selection of operation

- The output operation can be selected by the operation / frequency selection switch on the receiver.
(Make sure that the power supply is off while setting the selection switch.)

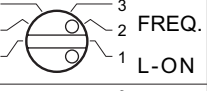
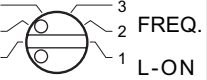
	State of operation / frequency selection switch	Output operation
L-ON	 FREQ. 2 D-ON 1	OFF when one or more beams are interrupted.
D-ON	 FREQ. 2 D-ON 1	ON when one or more beams are interrupted.

Notes: 1) Selection of the output operation and the frequency for the receiver is carried out with the same switch. When the output operation is set, be sure to select the same frequency No. of the emitter and the receiver.
2) In case the operation / frequency selection switch is set to the position other than 1, 2 or 3, the state of the receiver is in D-ON / frequency 1.

Orientation

- The emitter and the receiver must face each other correctly. If they are set upside down, the sensor does not work.

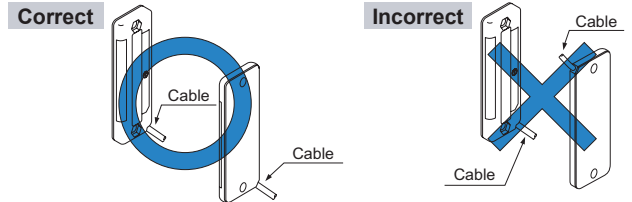

Interference prevention function

- By setting different emission frequencies, three units of **NA1-PK3** can be mounted close together, as shown in the figure on the below.

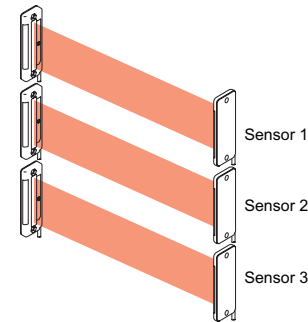

- However, if the sensors are mounted close together as shown in the figure below, up to 2 sets of sensors are possible.

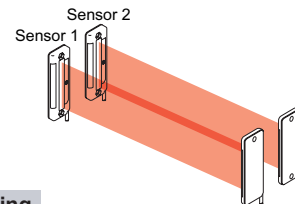

Frequency setting

- Set the both emitting and receiving frequency of Sensor 1 to FREQ. 1, the both emitting and receiving frequency of Sensor 2 to FREQ. 2 and the both emitting and receiving frequency of Sensor 3 to FREQ. 3.
(Make sure that the power supply is off while setting the selection switch.)

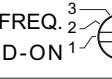
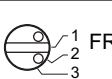
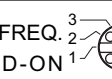
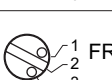
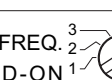
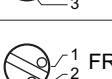
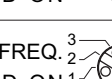
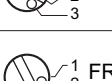
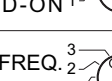
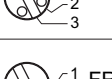
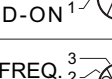
		Emitter		Receiver	
		Frequency selection switch		Operation / Frequency selection switch	
Sensor 1	L-ON	 FREQ. 1	 FREQ. 1 D-ON 1		
	D-ON	 FREQ. 2	 FREQ. 2 D-ON 1		
Sensor 2	L-ON	 FREQ. 2	 FREQ. 2 D-ON 1		
	D-ON	 FREQ. 3	 FREQ. 3 D-ON 1		
Sensor 3	L-ON	 FREQ. 3	 FREQ. 3 D-ON 1		
	D-ON	 FREQ. 1	 FREQ. 1 D-ON 1		

Notes: 1) Take care that selection of the output operation and the frequency for the receiver is carried out with the same switch.
2) In case the frequency switch and the operation / frequency selection switch is set to the position other than 1, 2 or 3, the state of the emitter is in frequency 1 and that of the receiver is in D-ON / frequency 1.

- FIBER SENSORS
- LASER SENSORS
- PHOTO-ELECTRIC SENSORS
- MICRO PHOTO-ELECTRIC SENSORS
- AREA SENSORS
- LIGHT CURTAINS / SAFETY COMPONENTS
- PRESSURE / FLOW SENSORS
- INDUCTIVE PROXIMITY SENSORS
- PARTICULAR USE SENSORS
- SENSOR OPTIONS
- SIMPLE WIRE-SAVING UNITS
- WIRE-SAVING SYSTEMS
- MEASUREMENT SENSORS
- STATIC ELECTRICITY PREVENTION DEVICES
- LASER MARKERS
- PLC
- HUMAN MACHINE INTERFACES
- ENERGY CONSUMPTION VISUALIZATION COMPONENTS
- FA COMPONENTS
- MACHINE VISION SYSTEMS
- UV CURING SYSTEMS

- Selection Guide
- Slim Body
- Picking
- Other Products

- NA1-PK5/NA1-5
- NA1-PK3

- FIBER SENSORS
- LASER SENSORS
- PHOTO-ELECTRIC SENSORS
- MICRO PHOTO-ELECTRIC SENSORS
- AREA SENSORS
- LIGHT CURTAINS/SAFETY COMPONENTS
- PRESSURE / FLOW SENSORS
- INDUCTIVE PROXIMITY SENSORS
- PARTICULAR USE SENSORS
- SENSOR OPTIONS
- SIMPLE WIRE-SAVING UNITS
- WIRE-SAVING SYSTEMS
- MEASUREMENT SENSORS
- STATIC ELECTRICITY PREVENTION DEVICES
- LASER MARKERS
- PLC
- HUMAN MACHINE INTERFACES
- ENERGY CONSUMPTION VISUALIZATION COMPONENTS
- FA COMPONENTS
- MACHINE VISION SYSTEMS
- UV CURING SYSTEMS
- Selection Guide
- Slim Body
- Picking
- Other Products
- NA1-PK5/NA1-5
- NA1-PK3

PRECAUTIONS FOR PROPER USE

Refer to p.1458~ for general precautions.

Wiring

- Make sure that the power supply is off while wiring and setting the selection switch.
- Take care that wrong wiring may damage the sensor.
- Verify that the supply voltage variation is within the rating.
- If power is supplied from a commercial switching regulator, ensure that the frame ground (F.G.) terminal of the power supply is connected to an actual ground.
- In case noise generating equipment (switching regulator, inverter motor, etc.) is used in the vicinity of the sensor, connect the frame ground (F.G.) terminal of the equipment to an actual ground.
- Extension up to total 100 m **328.084 ft** is possible with 0.3 mm², or more, cable for both emitter and receiver. However, in order to reduce noise, make the wiring as short as possible.
- Do not run the wires together with high-voltage lines or power lines or put them in the same raceway. This can cause malfunction due to induction.

- Make sure to use an isolation transformer for the DC power supply. If an auto-transformer (single winding transformer) is used, this product or the power supply may get damaged.
- In case a surge is generated in the used power supply, connect a surge absorber to the supply and absorb the surge.

Others

- Do not use during the initial transient time (0.5 sec.) after the power supply is switched on.
- Take care that the sensor is not directly exposed to fluorescent light from a rapid-starter lamp or a high frequency lighting device, as it may affect the sensing performance.
- Avoid dust, dirt, and steam.
- Take care that the product does not come in direct contact with water, oil, grease or organic solvents, such as, thinner, etc.
- To select the switch, a minus screwdriver is necessary. (Tip dimension: 2.5 × 0.6 mm **0.098 × 0.024 in**)
- These sensors are only for indoor use.

DIMENSIONS (Unit: mm in)

The CAD data in the dimensions can be downloaded from our website.

NA1-PK3 NA1-PK3-PN

Sensor

Emitter

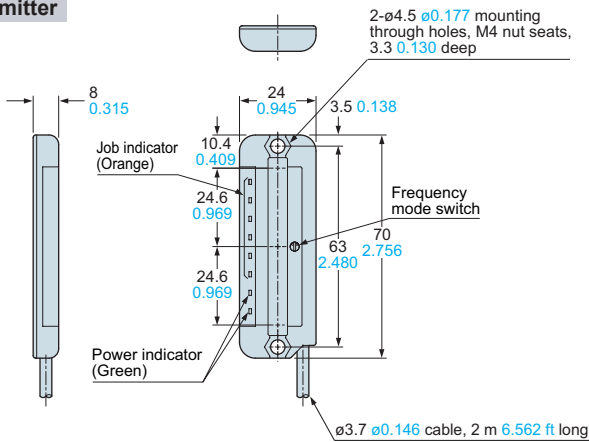

Receiver

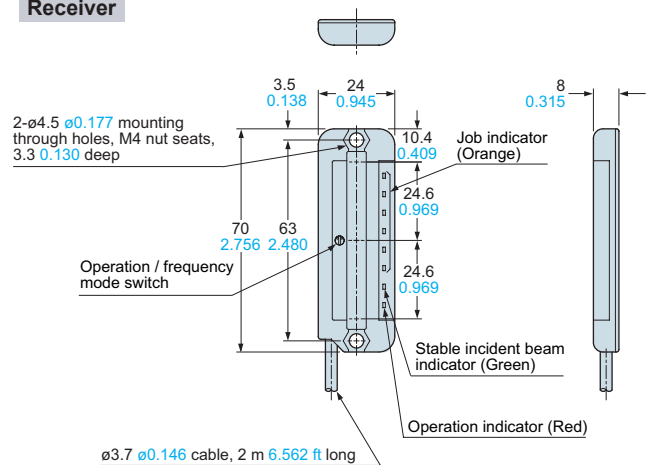

MS-NA3-3

Sensor protection bracket (Optional)

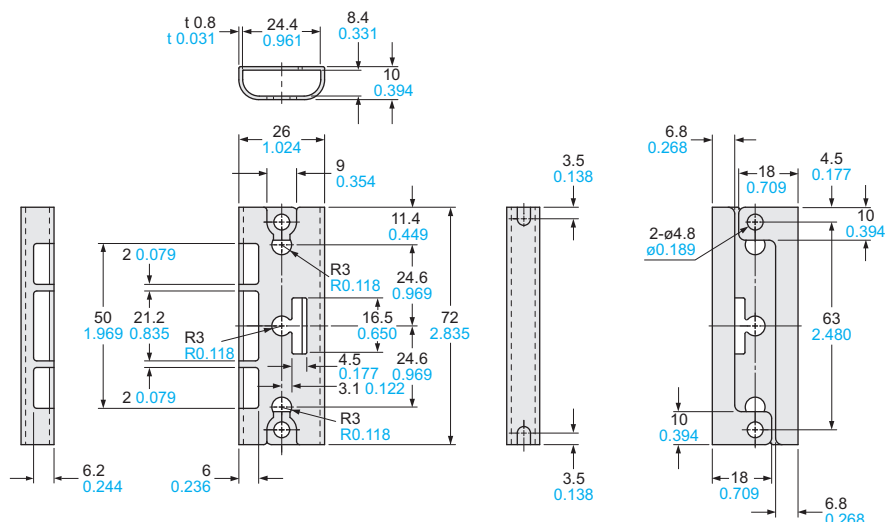

Material: Cold rolled carbon steel (SPCC) (Black chromate)

Two bracket set
[Four M4 (length 15 mm 0.591 in) screws with washers and four nuts are attached.]

Note: The sensor protection bracket can be used for both the emitter and the receiver.