



Chipsmall Limited consists of a professional team with an average of over 10 year of expertise in the distribution of electronic components. Based in Hongkong, we have already established firm and mutual-benefit business relationships with customers from,Europe,America and south Asia,supplying obsolete and hard-to-find components to meet their specific needs.

With the principle of “Quality Parts,Customers Priority,Honest Operation,and Considerate Service”,our business mainly focus on the distribution of electronic components. Line cards we deal with include Microchip,ALPS,ROHM,Xilinx,Pulse,ON,Everlight and Freescale. Main products comprise IC,Modules,Potentiometer,IC Socket,Relay,Connector.Our parts cover such applications as commercial,industrial, and automotives areas.

We are looking forward to setting up business relationship with you and hope to provide you with the best service and solution. Let us make a better world for our industry!



Contact us

Tel: +86-755-8981 8866 Fax: +86-755-8427 6832

Email & Skype: info@chipsmall.com Web: www.chipsmall.com

Address: A1208, Overseas Decoration Building, #122 Zhenhua RD., Futian, Shenzhen, China



3.1W Stereo Filter-Free Class-D Audio Amplifier

1 Description

The NAU8223 is a stereo high efficiency filter-free Class-D audio amplifier, which is capable of driving a 4Ω load with up to 3.1W output power. This device provides chip enable pin with extremely low standby current and fast start-up time of 3.4ms. It has five selectable gain settings (i.e. 0dB, 6dB, 12dB, 18dB and 24dB), which can be controlled by a single gain pin.

The NAU8223 is ideal for the portable applications of battery drive, as it has advanced features like 87dB PSRR, 91% efficiency, ultra low quiescent current (i.e. 2.1mA at 3.7V for 2 channels) and superior EMI performance. It has the ability to configure the inputs in either single-ended or differential mode.

NAU8223 is available in Miniature QFN-20 package and TSSOP-20 package.

Key Features

- Low Quiescent Current:
 - 2.1mA at 3.7V for 2 channels
 - 3.2mA at 5V for 2 channels
- 5 Selectable Gain Settings:
 - 0dB / 6dB / 12dB / 18dB / 24dB
- Powerful Stereo Class-D Amplifier:
 - 2ch x 3.1W (4Ω @ 5V, 10% THD+N)
 - 2ch x 1.26W (4Ω @ 3.7V, 1% THD+N)
 - 2ch x 1.76W (8Ω @ 5V, 10% THD+N)
 - 2ch x 0.76W (8Ω @ 3.7V, 1% THD+N)
- Low Output Noise: 20 μV_{RMS} @0dB gain
- 87dB PSRR @217Hz
- Low Current Shutdown Mode
- Click-and Pop Suppression

Applications

- Notebooks / Tablet PCs
- Personal Media Players / Portable TVs
- MP3 Players
- Portable Game Players
- Digital Camcorders

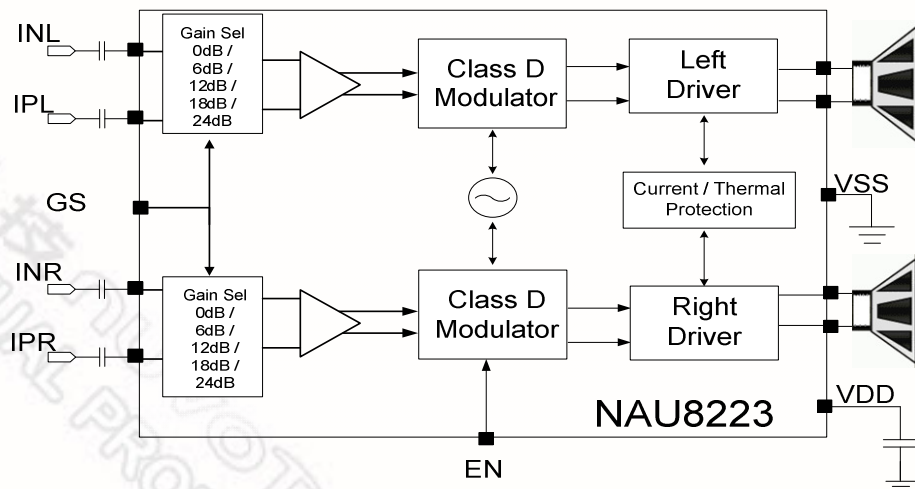
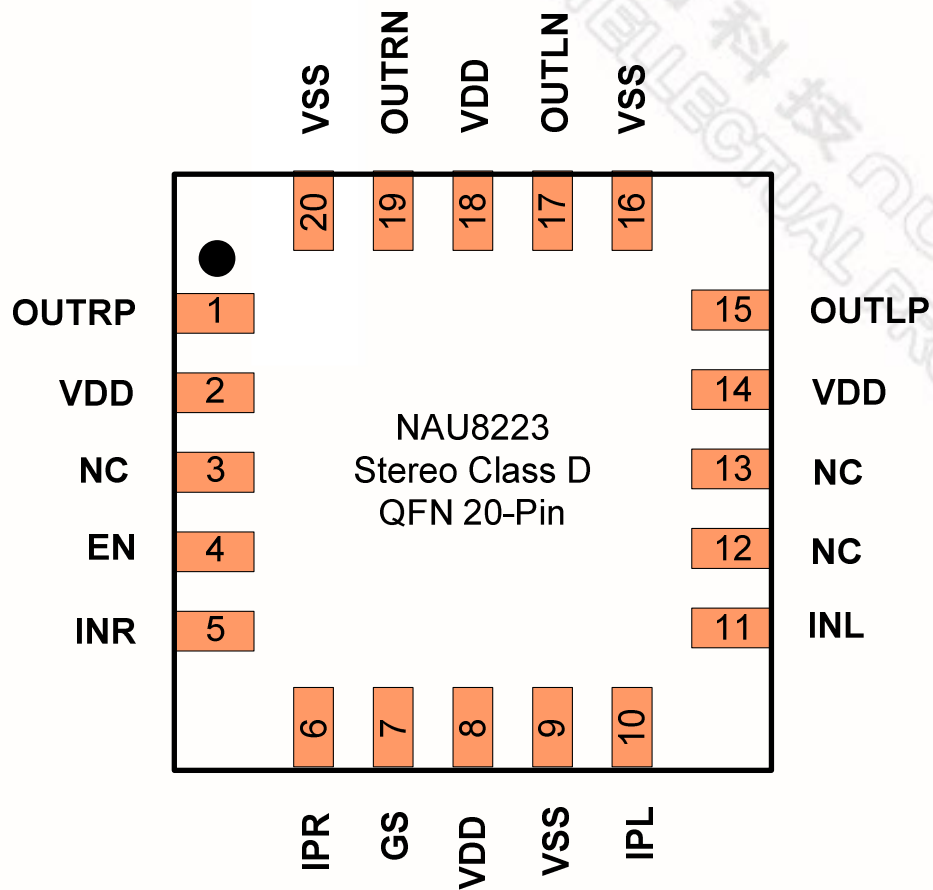

Figure 1: NAU8223 Block Diagram

2 Pinout

2.1 NAU8223 QFN 20 (TOP VIEW)



2.2 TSSOP 20 (TOP VIEW)

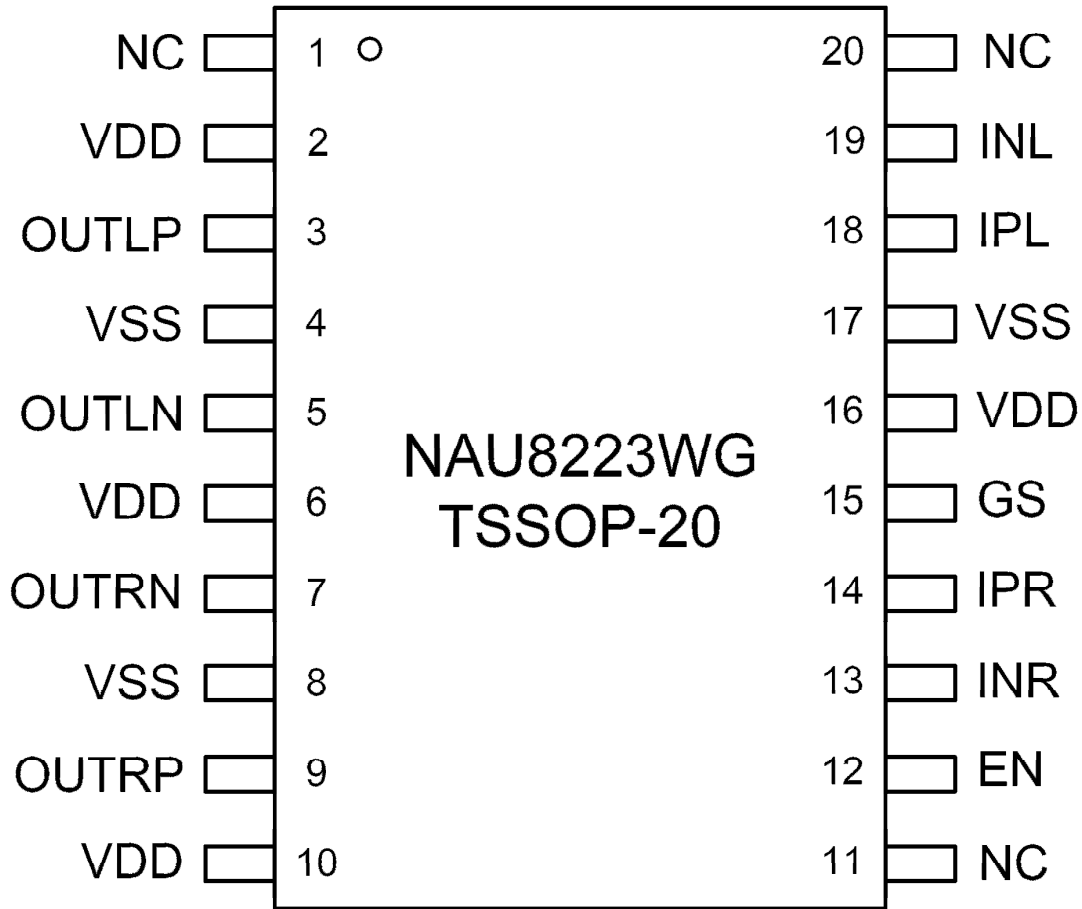

Part Number	Dimension	Package	Package Material
NAU8223YG	4mm x 4mm	QFN-20	Pb-Free
NAU8223WG	4.4mm x 6.5mm	TSSOP-20	Pb-Free

3 Pin Descriptions

QFN	TSSOP	Name	Type	Functionality
1	9	OUTRP	Analog Output	Right Channel Positive BTL Output
2	10	VDD	Supply	Power Supply
3	11	NC	NC	No Connect
4	12	EN	Digital Input	Chip Enable (High = Enable; Low = PD)
5	13	INR	Analog Input	Right Channel Negative Input
6	14	IPR	Analog Input	Right Channel Positive Input
7	15	GS	Analog Input	5 Selectable Gain Setting (0dB / 6dB / 12dB / 18dB / 24dB)
8	16	VDD	Supply	Power Supply
9	17	VSS	Supply	Ground
10	18	IPL	Analog Input	Left Channel Positive Input
11	19	INL	Analog Input	Left Channel Negative Input
12	20	NC	NC	No Connect
13	1	NC	NC	No Connect
14	2	VDD	Supply	Power Supply
15	3	OUTLP	Analog Output	Left Channel Positive BTL Output
16	4	VSS	Supply	Ground
17	5	OUTLN	Analog Output	Left Channel Negative BTL Output
18	6	VDD	Supply	Power Supply
19	7	OUTRN	Analog Output	Right Channel Negative BTL Output
20	8	VSS	Supply	Ground
21	-	Ex-Pad	Analog Input	Thermal Tab (must be connected to VSS, QFN-20 package, only)

Notes

1. Pins designated as NC (Not Internally Connected) should be left as no-connection

Table 1: NAU8223 Pin description

4 Electrical Characteristics

Conditions: EN = VDD = 5V, VSS = 0V, Av = 12dB ZL = ∞, Bandwidth = 20Hz to 22kHz, TA = 25 °C

Parameter	Symbol	Comments/Conditions	Min	Typ	Max	Units
Power Delivered						
Output Power (per channel)	P _{out}	Z _L = 4Ω + 33μH	VDD = 5.0V		3.1	W
		THD + N = 10%	VDD = 3.7V		1.57	
		Z _L = 4Ω + 33μH	VDD = 5.0V		2.46	
		THD + N = 1%	VDD = 3.7V		1.26	
		Z _L = 8Ω + 68μH	VDD = 5.0V		1.76	
		THD + N = 10%	VDD = 3.7V		0.95	
		Z _L = 8Ω + 68μH	VDD = 5.0V		1.41	
		THD + N = 1%	VDD = 3.7V		0.76	

Parameter	Symbol	Comments/Conditions	Min	Typ	Max	Units
Chip Enable (EN)						
Voltage Enable High	V _{EN_H}	VDD = 2.5V to 5.5V	1.4			V
Voltage Enable Low	V _{EN_L}	VDD = 2.5V to 5.5V			0.4	V
Input Leakage Current			-1		+1	μA
Thermal and Current Protection						
Thermal Shutdown Temperature				130		°C
Thermal Shutdown Hysteresis				15		°C
Short circuit Threshold	I _{LIMIT}			2.1		A
Gain Setting						
Voltage Gain	A _v	Tie GS to VSS		24		dB
		GS Connect VSS through 100k ± 5%		18		
		Tie GS pin to VDD		12		
		GS Connect VDD through 100k ± 5%		6		
		Floating Node		0		
Differential Input Resistance	R _{IN}	A _v = 24dB		35		kΩ
		A _v = 18dB		70		
		A _v = 12dB		140		
		A _v = 6dB		280		
		A _v = 0dB		558		

Electrical Characteristics (continued)

Conditions: EN = VDD = 5V, VSS = 0V, Av = 12dB, ZL = ∞, Bandwidth = 20Hz to 22kHz, TA = 25 °C

Parameter	Symbol	Comments/Conditions	Min	Typ	Max	Units
Normal Operation						
Quiescent Current Consumption	I _{QUI}	VDD = 3.7V		2.1		mA
		VDD = 5V		3.17		mA
Shut Down Current	I _{OFF}	EN = 0		0.1		μA
Oscillator Frequency	f _{OSC}			300		kHz
Efficiency	η			91		%
Start Up Time	T _{start}			3.4		msec
Output Offset Voltage	V _{OS}			±1	±4	mV
Common Mode Rejection Ratio	CMRR	f _{IN} = 1kHz		80		dB
Click-and-Pop Suppression		Into Shutdown (Z _L =8Ω) A Weighted		-72		dBV
Power Supply Rejection Ratio	DC PSRR	VDD = 2.5V to 5.5V		98		dB
	AC PSRR*	V _{RIPPLE} = 0.2Vpp@217Hz**		87		dB
		V _{RIPPLE} = 0.2Vpp@1KHz V _{RIPPLE} = 0.2Vpp@10KHz		74 54		
Channel Crosstalk		f _{IN} = 1kHz, Z _L = 8Ω + 68μH		-101		dB

*Measured with 0.1uF capacitor on V_{DD} and Battery supply

** Measured with 2.2uF input capacitor.

Parameter	Symbol	Comments/Conditions	Min	Typ	Max	Units
Noise Performance						
		Av = 0dB (A-weighted)		20		μV _{RMS}
		Av = 6dB (A-weighted)		21		
		Av = 12dB (A-weighted)		27		
		Av = 18dB (A-weighted)		36		
		Av = 24dB (A-weighted)		52		

The following setup is used to measure the above parameters

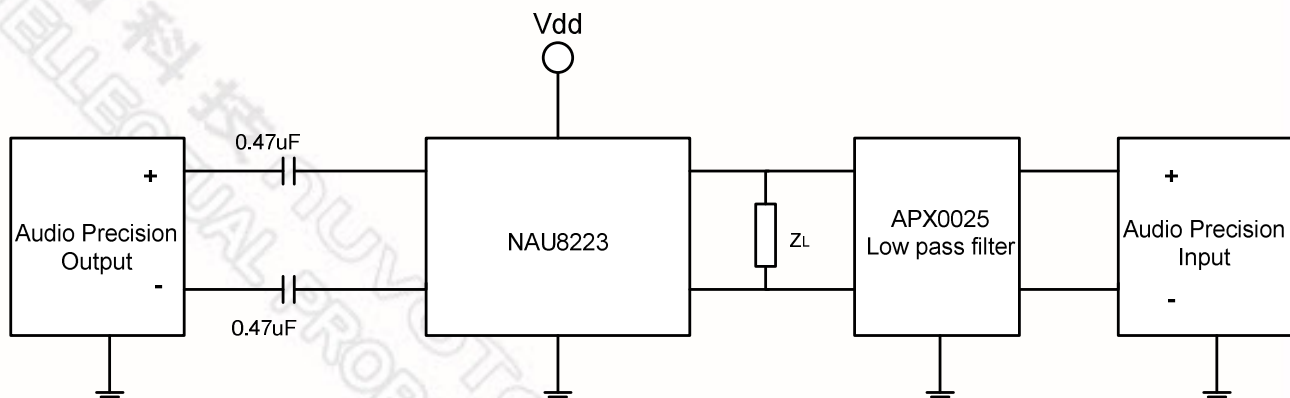

Absolute Maximum Ratings

Condition	Min	Max	Units
Analog supply	-0.50	+5.50	V
Industrial operating temperature	-40	+85	°C
Storage temperature range	-65	+150	°C

CAUTION: Do not operate at or near the maximum ratings listed for extended periods of time. Exposure to such conditions may adversely influence product reliability and result in failures not covered by warranty.

Operating Conditions

Condition	Symbol	Min	Typical	Max	Units
Analog supply range	VDD	2.50	3.7	5.50	V
Ground	VSS		0		V

6 Special Feature Description

The NAU8223 offers excellent quantity performance as high efficiency, high output power and low quiescent current. It also provides the following special features.

6.1 Gain Setting

The NAU8223 has a GS pin, which can control five selectable gain settings (i.e. 0dB / 6dB / 12dB / 18dB / 24dB).

GS Pin Configuration	Internal Gain (dB)
GS tie to VSS	24
GS connect to VSS through 100kΩ ± 5% resistor	18
GS tie to VDD	12
GS connect to VDD through 100kΩ ± 5% resistor	6
Floating (open node)	0

6.2 Device Protection

The NAU8223 includes device protection for three operating scenarios. They are

1. Thermal Overload
2. Short circuit
3. Supply under voltage

6.2.1 Thermal Overload Protection

When the device internal junction temperature reaches 130°C, the NAU8223 will disable the output drivers. When the device cools down and a safe operating temperature of 115°C has been reached for at least about 47mSec, the output drivers will be enabled again.

6.2.2 Short Circuit Protection

If a short circuit is detected on any of the pull-up or pull-down devices on the output drivers for at least 14uSec, the output drivers will be disabled for 47mSec. The output drivers will then be enabled again and check for the short circuit. If the short circuit is still present, the output drivers are disabled after 14uSec. This cycle will continue until the short circuit is removed. The short circuit threshold is set at 2.1A.

6.2.3 Supply under Voltage Protection

If the supply voltage drops under 2.1V, the output drivers will be disabled while the NAU8223 control circuitry still operates. This will avoid the battery supply to drag down too low before the host processor can safely shut down the devices on the system. If the supply drops further below 1.0v the internal power on reset activated and puts the entire device in power down state.

6.3 Power up and Power down Control

When the supply voltage ramps up, the internal power on reset circuit gets triggered. At this time all internal circuits will be set to power down state. The device can be enabled by setting the EN pin high. Upon setting the EN pin high, the device will go through an internal power up sequence in order to minimize 'pops' on the speaker output. The complete power up sequence will take about 3.4mSec. The device will power down in about 30uSec, when the EN pin is set low.

It is important to keep the input signal at zero amplitude or enable the mute condition in order to minimize the 'pops' when the EN pin is toggled.

7 Typical Operating Characteristics

Conditions: $V_{DD} = 5V$, $V_{SS} = 0V$, $A_v = 12dB$, $Z_L = \infty$, Bandwidth = 20Hz to 22kHz, $T_A = 25^\circ C$, unless otherwise noted

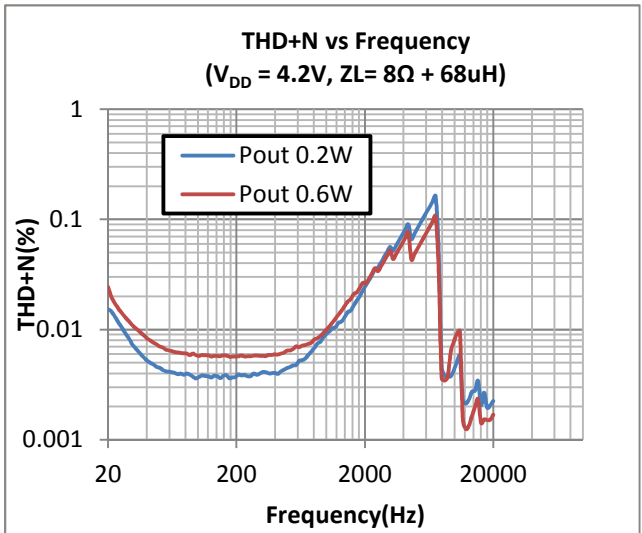
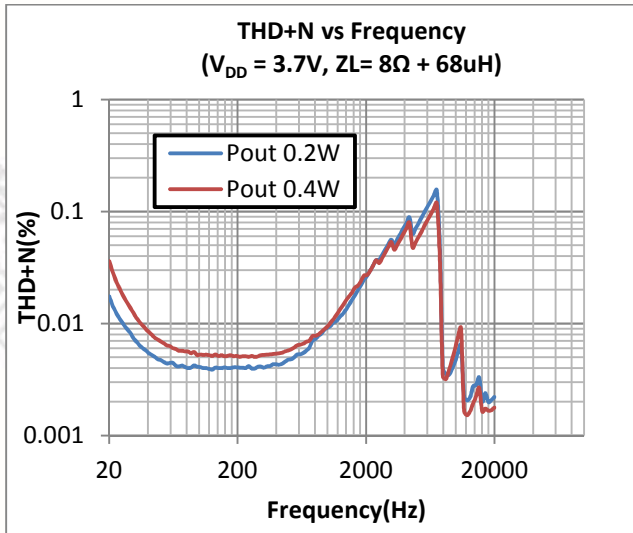
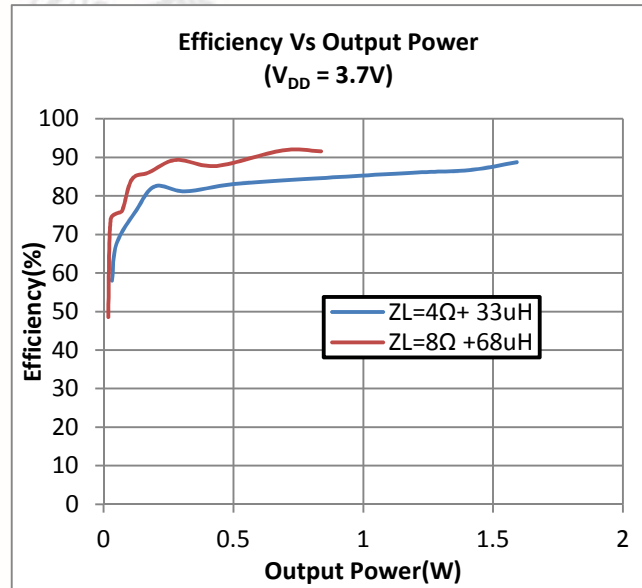
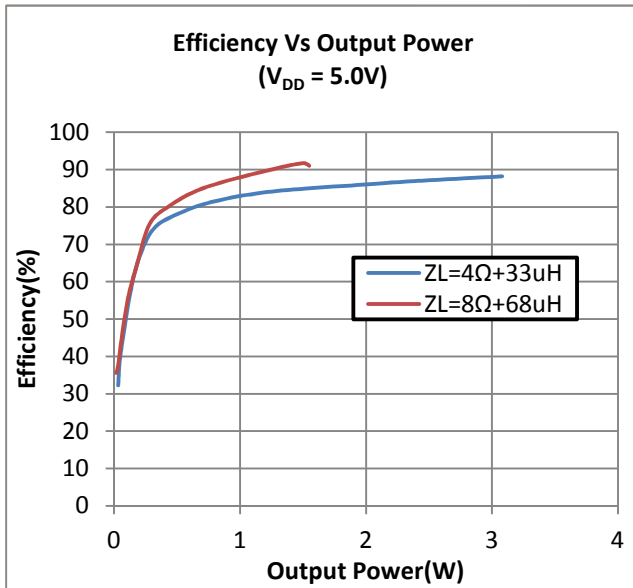

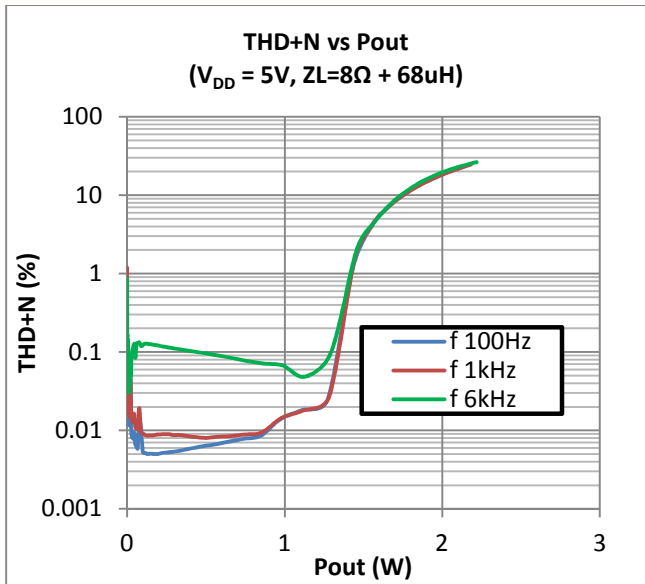
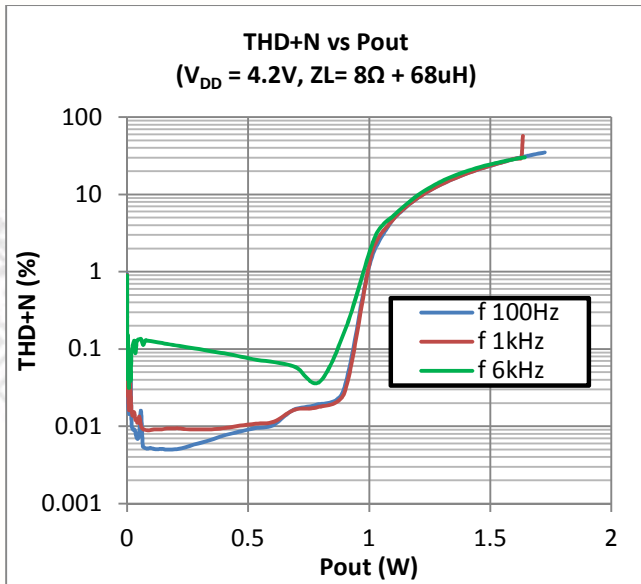
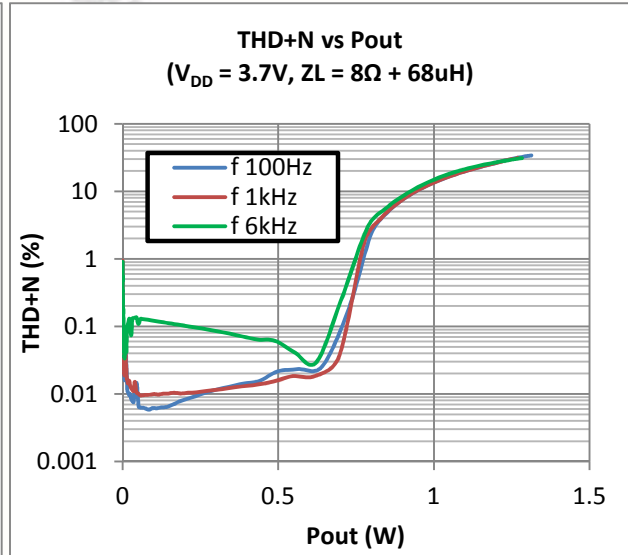
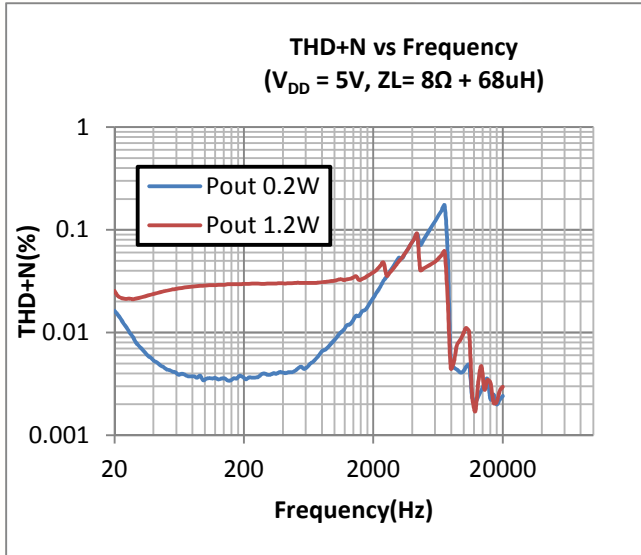

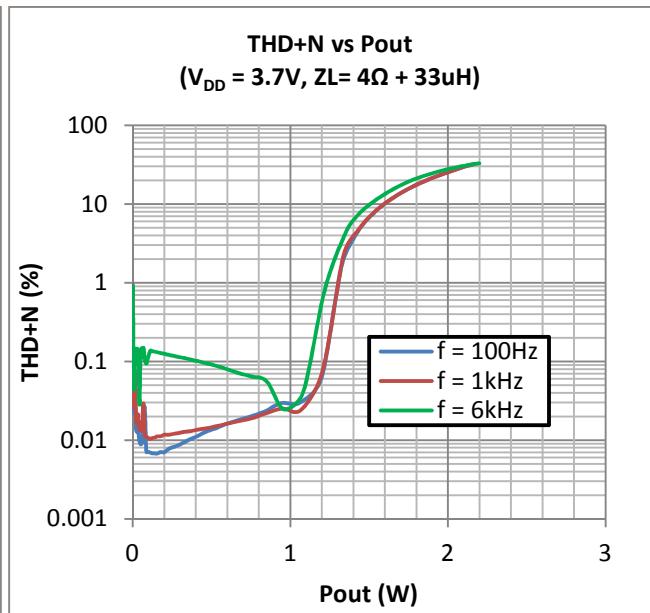
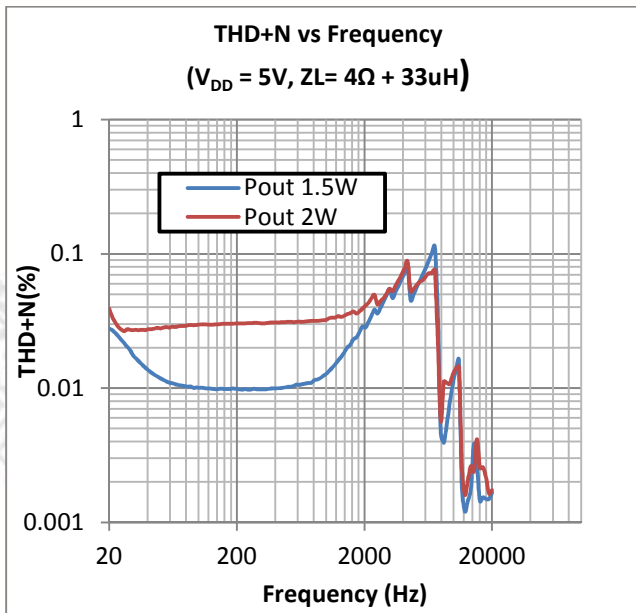
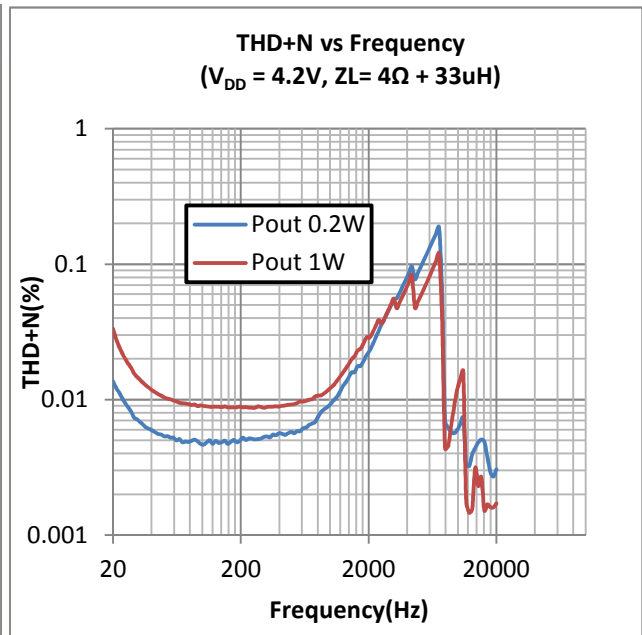
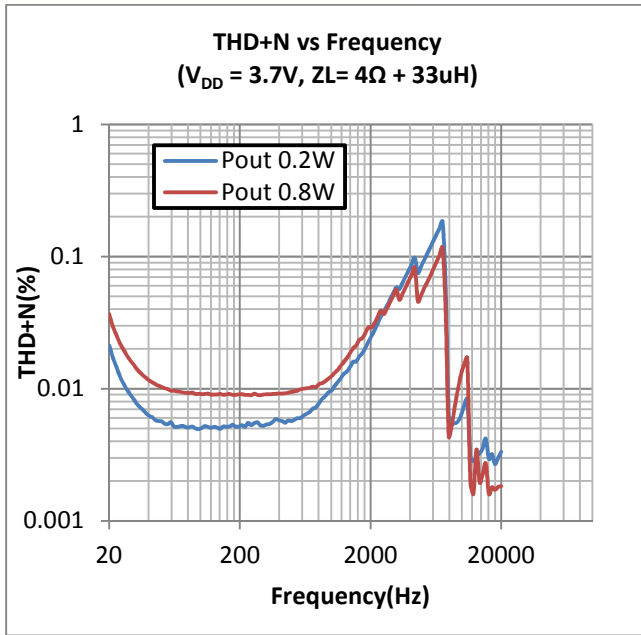

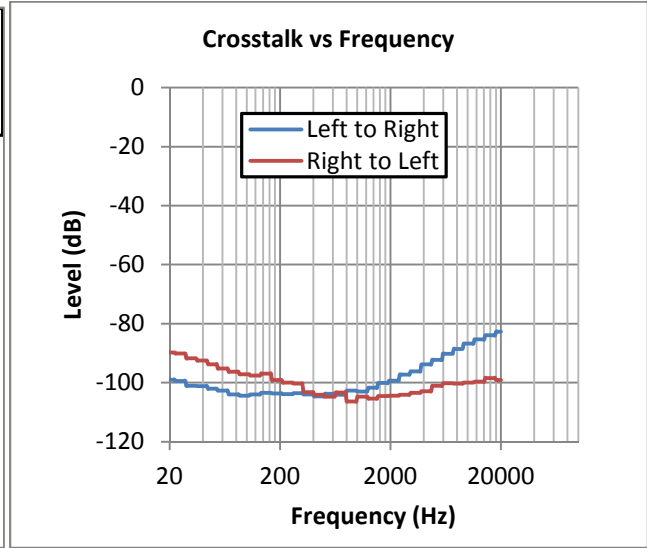
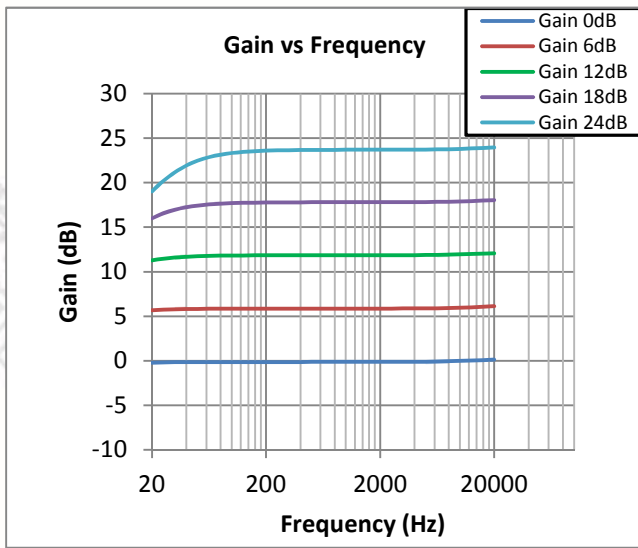
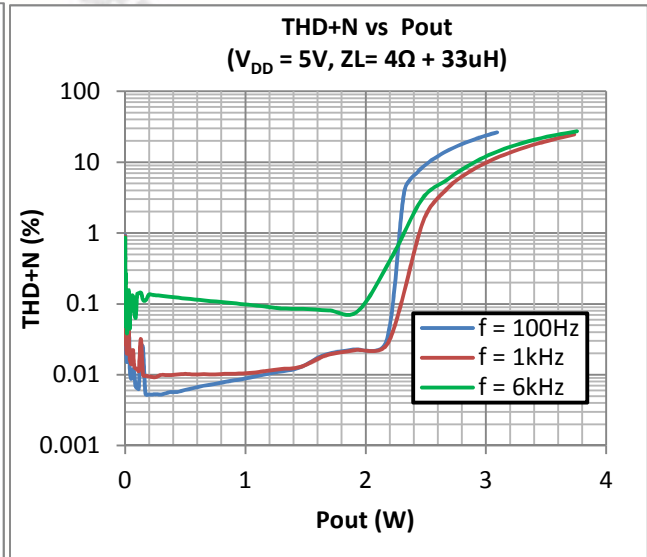
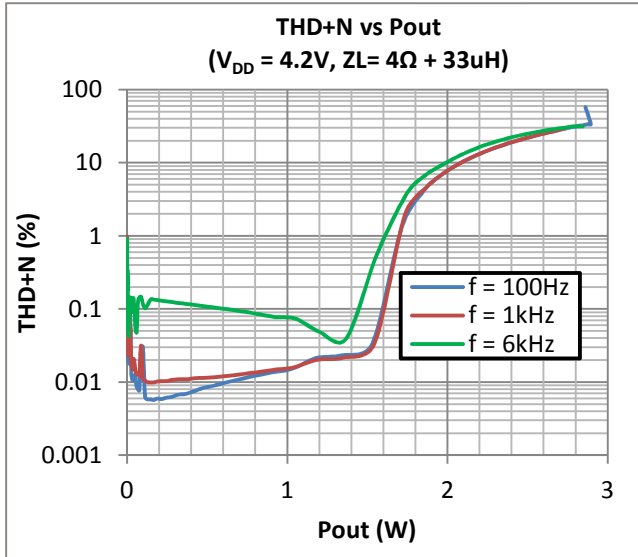

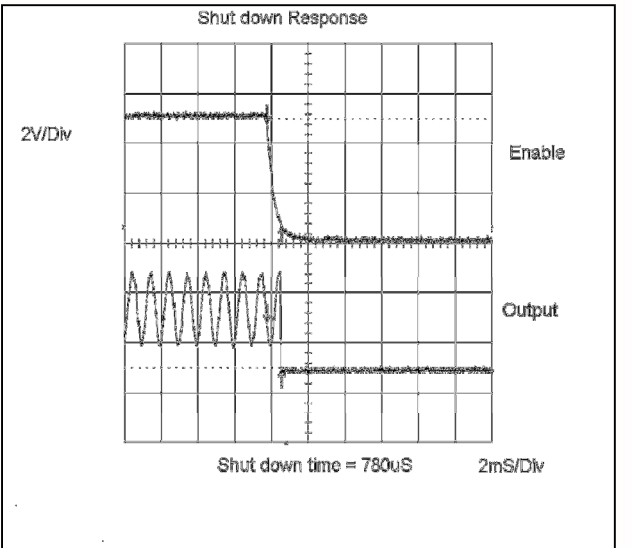
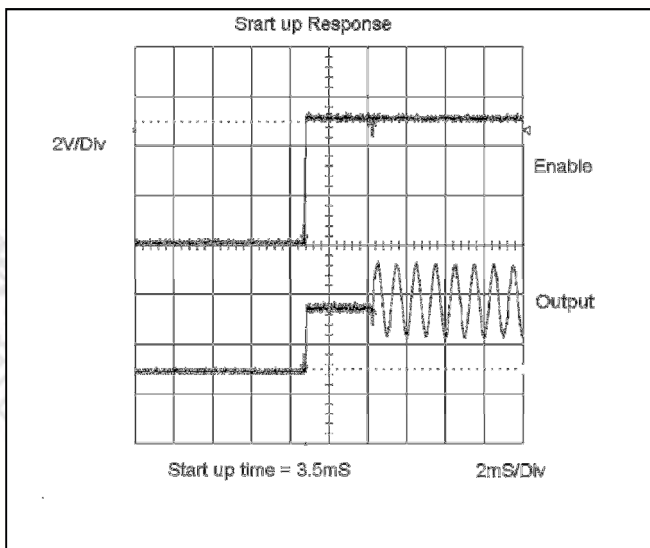
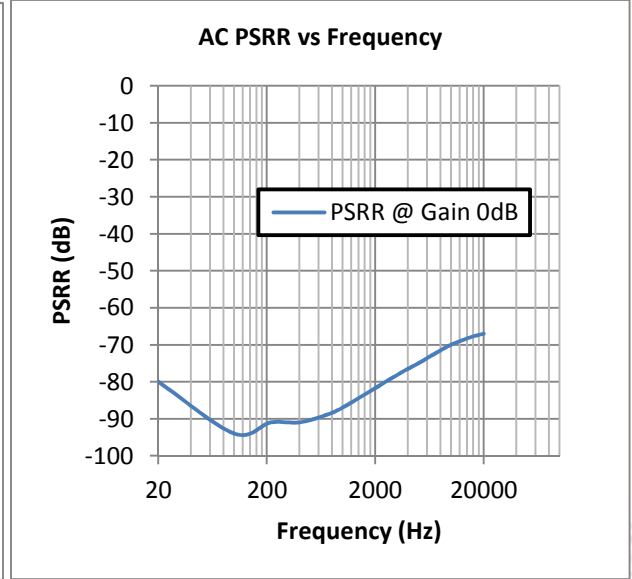
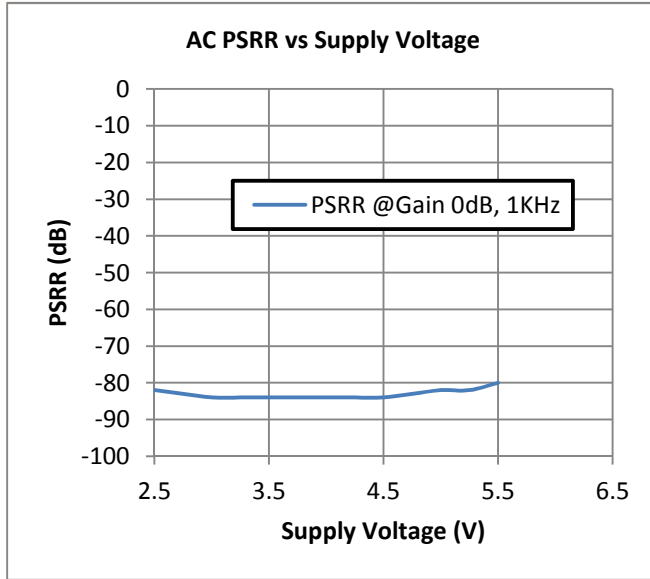

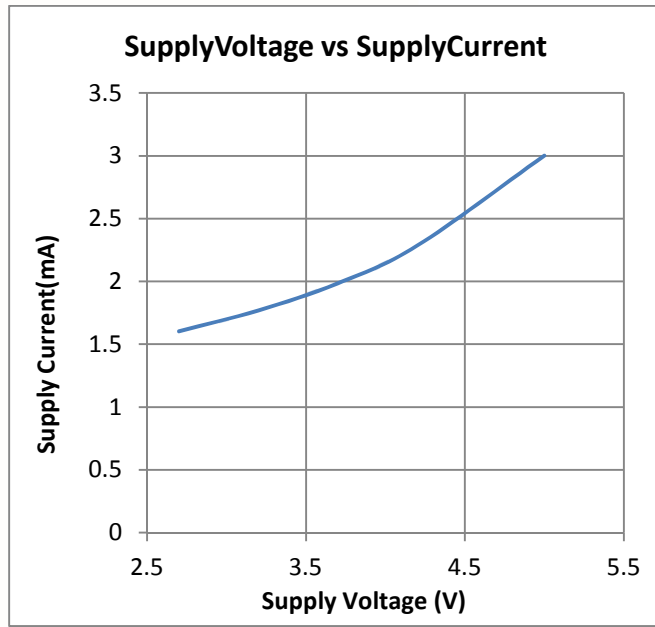

新唐科技 NUVOTON
INTELLECTUAL PROPERTY

新唐科技 NUVOTON
INTELLECTUAL PROPERTY

8 Application Information

8.1 Application diagram

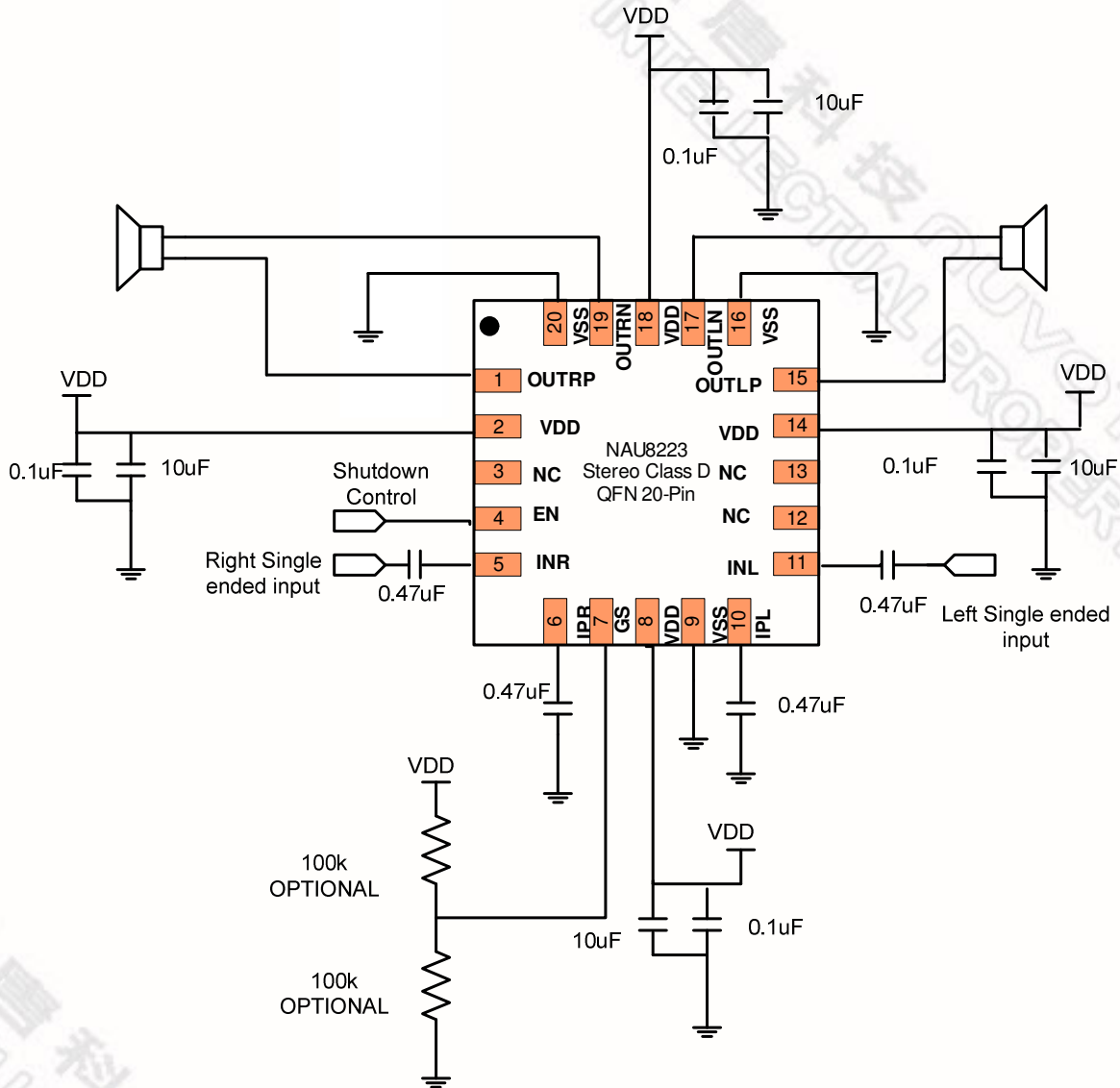

P.S. GS Pin – The 100kΩ resistors are optional. GS can be floating for internal gain setting = 0dB. Please refer Section 2.1 (Gain Setting) for the detailed explanation.

8.2 Component selection

Coupling Capacitors

An ac coupling capacitor (C_{in}) is used to block the dc content from the input source. The input resistance of the amplifier (R_{in}) together with the C_{in} will act as a high pass filter. So depending on the required cut off frequency the C_{in} can be calculated by using the following formula

Where f_c is the desired cut off frequency of the High pass filter.

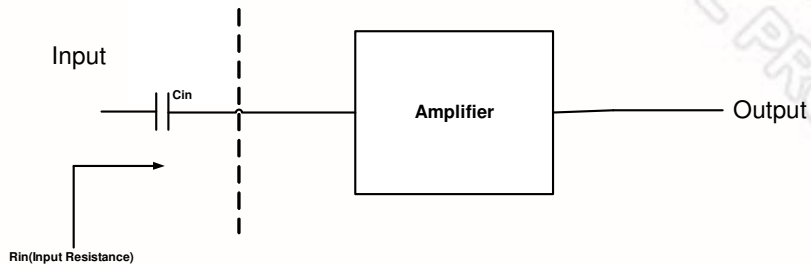

Bypass Capacitors

Bypass capacitors are required to remove the ac ripple on the VDD pins. The value of these capacitors depends on the length of the VDD trace. In most cases, 10 μ F and 0.1 μ F are enough to get the good performance.

8.3 Layout considerations

The NAU8223 QFN package uses an exposed pad on the bottom side of the package to dissipate excess power from the output drivers. This pad must be soldered carefully to the PCB for proper operation of the NAU8223. This pad is internally connected to Vss. A typical layout is shown below.

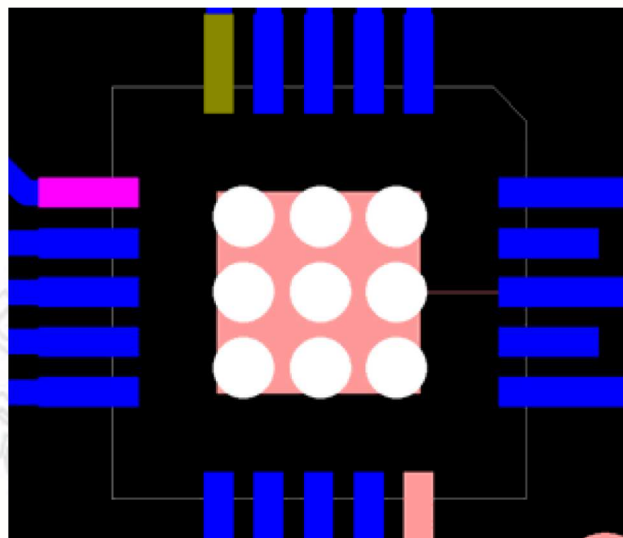

The PCB has to be designed in such a manner that it should have nine vias in 3x3 grid under NAU8223. The vias should have hole size of 12mil and a spacing of 30mils. The pad size of the vias is 24mils. The vias on the top side of the board should be connected with a copper pour that has an area of 2mm x 2mm, centered underneath the NAU8223. The nine vias should connect to copper pour area on the bottom of the PCB. It is preferred to pour the complete bottom side of the board with Vss.

Also good PCB layout and grounding techniques are essential to get the good audio performance. It is better to use low resistance traces as these devices are driving low impedance loads. The resistance of the traces has a significant effect on the output power delivered to the load. In order to dissipate more heat, use wide traces for the power and ground lines.

8.4 Class D without filter

The NAU8223 is designed for use without any filter on the output line. That means the outputs can be directly connected to the speaker in the simplest configuration. This type of filter less design is suitable for portable applications where the speaker is very close to the amplifier. In other words, this is preferable in applications where the length of the traces between the speaker and amplifier is short. The following diagram shows this simple configuration.

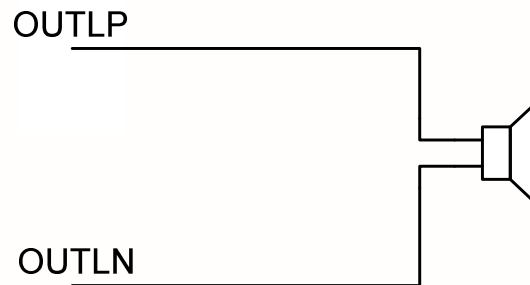

NAU8223 outputs connected to speaker without filter circuit

8.5 Class D with filter

In some applications, the shorter trace lengths are not possible because of speaker size limitations and other layout reasons. In these applications, the long traces will cause EMI issues. There are two types of filter circuits available to reduce the EMI effects. These are ferrite bead and LC filters.

Ferrite Bead filter

The ferrite bead filters are used to reduce the high frequency emissions. The typical circuit diagram is shown in the figure.

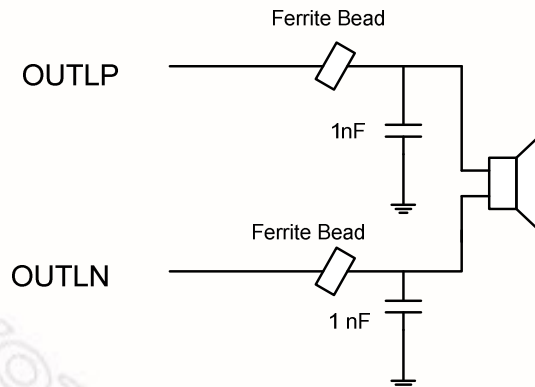

NAU8223 outputs connected to speaker with Ferrite Bead filter

The characteristic of ferrite bead is such that it offers higher impedance at high frequencies. For better EMI performance select ferrite bead which offers highest impedance at high frequencies, so that it will attenuate the signals at higher frequencies. Usually the ferrite beads have low impedance in the audio range, so it will act as a pass through filter in the audio frequency range.

LC filter

The LC filter is used to suppress the low frequency emissions. The following diagram shows the NAU8223 outputs connected to the speaker with LC filter circuit. R_L is the resistance of the speaker coil.

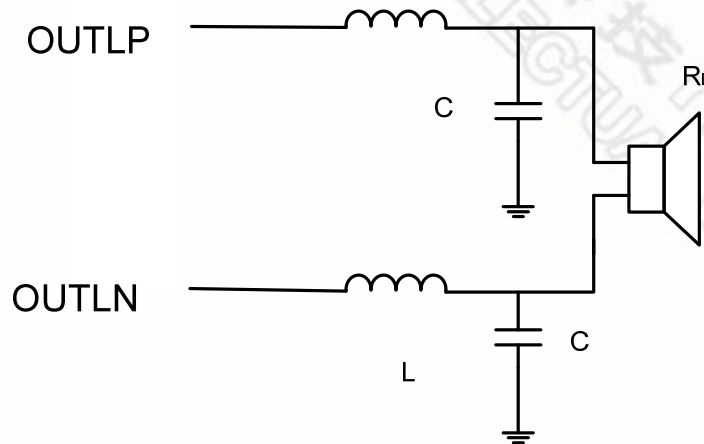

NAU8223 outputs connected to speaker with LC filter

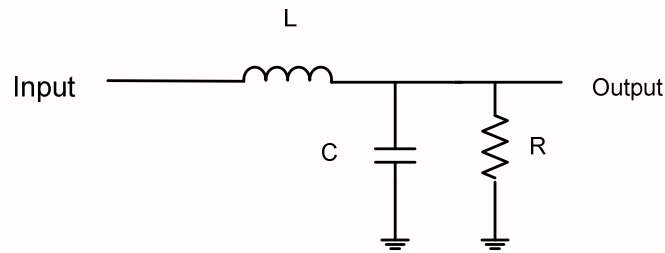

Standard Low pass LCR filter

The following are the equations for the critically damped ($\zeta = 0.707$) standard low pass LCR filter

$$2\pi f_c = \frac{1}{\sqrt{LC}} \quad f_c \text{ is the cutoff frequency}$$

$$\zeta = 0.707 = \frac{1}{2R} * \sqrt{\frac{L}{C}}$$

The L and C values for differential configuration can be calculated by duplicating the single ended configuration values and substituting $R_L = 2R$.

8.6 NAU8223 EMI performance

The NAU8223 includes a spread spectrum oscillator for reduced EMI. The PWM oscillator frequency typically sweeps in a range of 300 kHz +/- 15 kHz in order to spread the energy of the PWM pulses over a larger frequency band. In addition, slew rate control on the output drivers allows the application of 'filter less' loads, while suppressing EMI at high frequencies. The below graph shows the EMI performance of NAU8223 with ferrite beads and speaker cable length of 30cm.

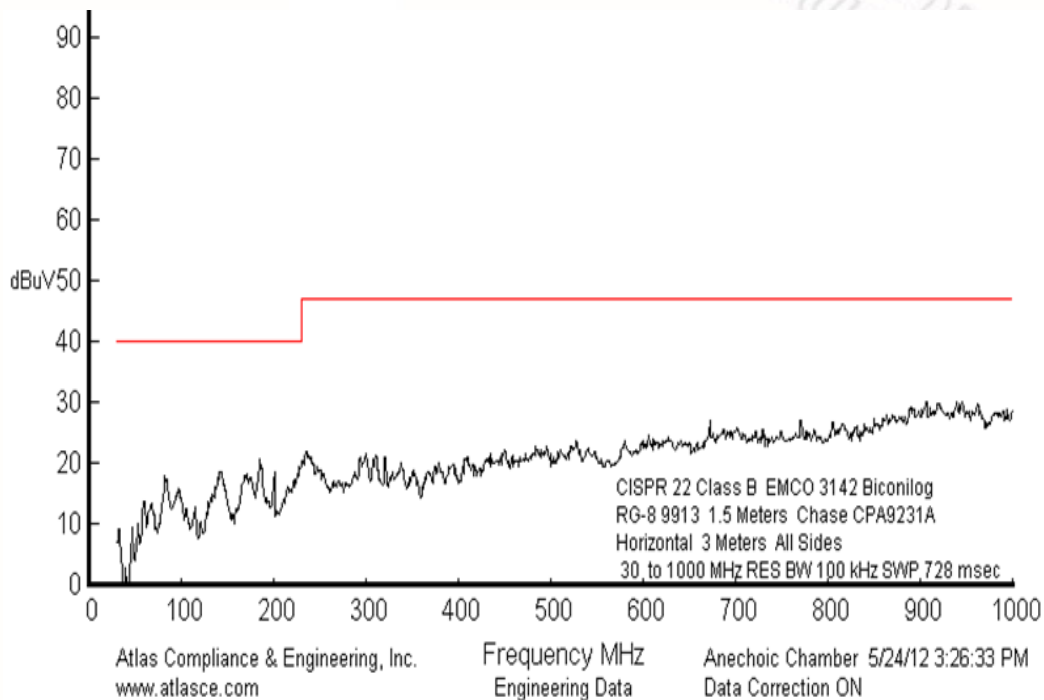

9 Package Dimensions

9.1 QFN20L 4X4 MM², Pitch:0.50 MM

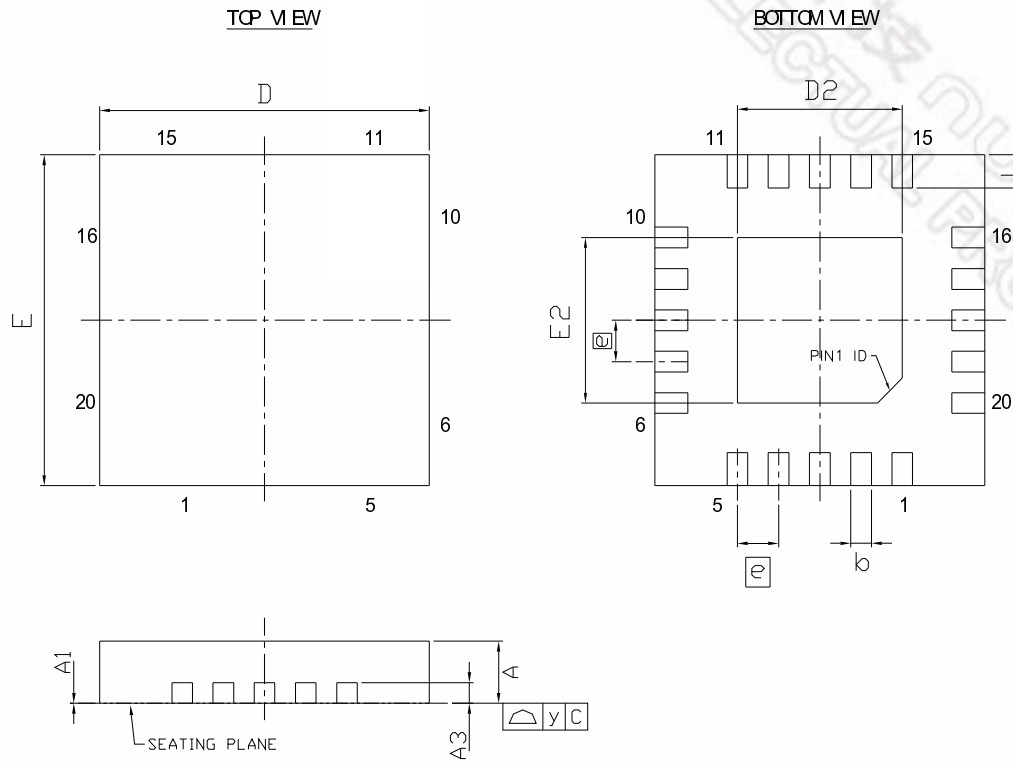

Controlling Dimension :Millimeters

SYMBOL	DIMENSION (MM)			DIMENSION (Inch)		
	MIN.	NOM.	MAX.	MIN.	NOM.	MAX.
A	0.70	0.75	0.80	0.02756	0.02953	0.03150
A1	0	0.02	0.05	0	0.0079	0.00197
A3	0.203 REF			0.0079 REF		
b	0.18	0.25	0.30	0.00709	0.00984	0.01181
D	3.90	4.00	4.10	0.1535	0.1575	0.1614
D2	1.90	2.00	2.10	0.0748	0.0787	0.0827
E	3.90	4.00	4.10	0.1535	0.1575	0.1614
E2	1.90	2.00	2.10	0.0748	0.0787	0.0827
e	0.50 BSC			0.01969 BSC		
L	0.30	0.40	0.50	0.01181	0.01574	0.01969
y	0.08			0.00315		

Note:D2,E2 by die size difference .

9.2 TSSOP20L 4.4X6.5 MM², Pitch:0.65 MM

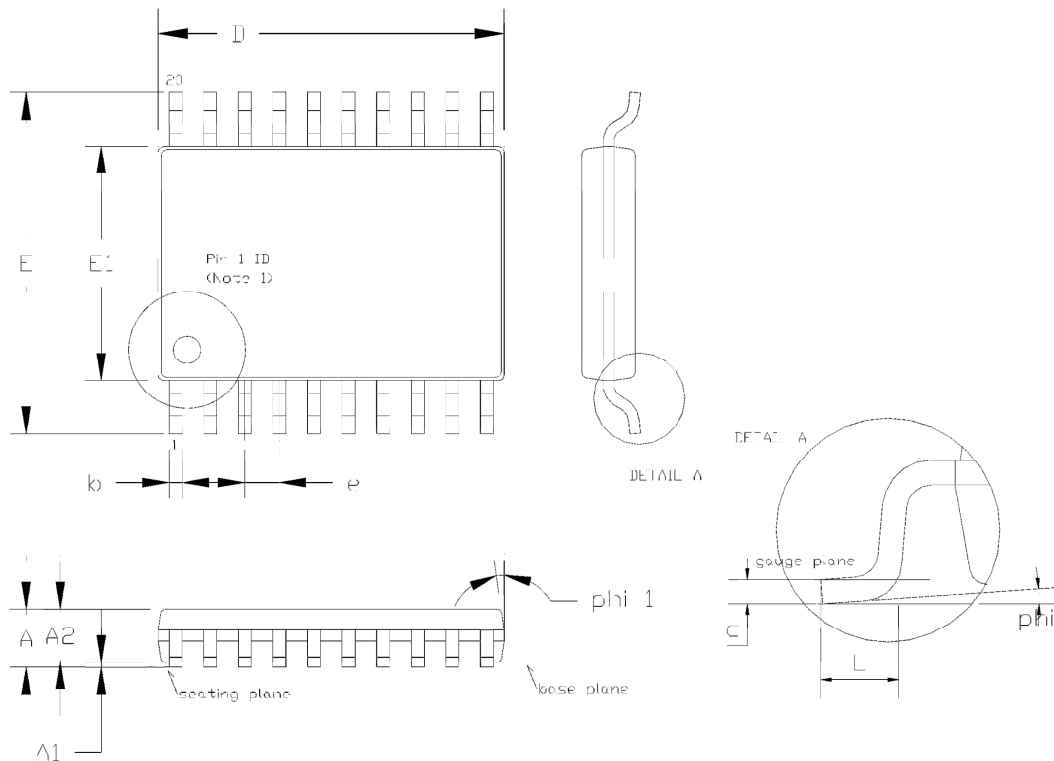

Description	Symbol	mm			inch		
		min	typ	max	min	typ	max
Package height	A	--	--	1.20	--	--	0.047
Stand off	A1	0.05	--	0.15	0.002	--	0.006
Package body thickness	A2	0.80	1.00	1.05	0.031	0.039	0.041
Width of terminal leads, inclusive lead finish	b	0.19	--	0.30	0.007	--	0.012
Thickness of terminal leads, inclusive lead finish	c	0.09	--	0.20	0.004	--	0.008
Package length	D	6.40	6.50	6.60	0.252	0.256	0.260
Package width	E	6.40 BSC			0.252 BSC		
Package body width	E1	4.30	4.40	4.50	0.169	0.173	0.177
Lead pitch	e	0.65 BSC			0.026 BSC		
Length of terminal for soldering to substrate	L	0.45	0.60	0.75	0.018	0.024	0.030
Angle of lead mounting area	phi [°]	0	--	8	0	--	8
mold release angle	phi1 [°]	12 REF			12 REF		
Number of terminal positions	N	20			20		

Note: the mm values are valid, the inch values contains rounding errors

10 Ordering Information

Nuvoton Part Number Description

NAU8223 **G**

Package Material:

G = Pb-free Package

Package Type:

Y = 20-Pin QFN Package

W = 20-Pin TSSOP Package

Version History

VERSION	DATE	PAGE	DESCRIPTION
Rev1.0	March, 2012	P.8, P.9	Preliminary Revision Updated typical characteristics
Rev1.1	March, 2012	P.2, P.10	Updated Pin No. Added application diagrams
Rev1.2	May, 2012	NA	Updated Electrical Characteristics
Rev1.3	July, 2012	P.4, P.5, P.10-P.18	Added Application information section Added/Modified Typical operating Characteristics Updated Electrical Characteristics
Rev1.4	August, 2013	P.4, P.5, P.22,P.23	Added TSSOP20 Package information section

Table 1: Version History

Important Notice

Nuvoton products are not designed, intended, authorized or warranted for use as components in systems or equipment intended for surgical implantation, atomic energy control instruments, airplane or spaceship instruments, transportation instruments, traffic signal instruments, combustion control instruments, or for other applications intended to support or sustain life. Furthermore, Nuvoton products are not intended for applications wherein failure of Nuvoton products could result or lead to a situation wherein personal injury, death or severe property or environmental damage could occur.

Nuvoton customers using or selling these products for use in such applications do so at their own risk and agree to fully indemnify Nuvoton for any damages resulting from such improper use or sales.