



Chipsmall Limited consists of a professional team with an average of over 10 year of expertise in the distribution of electronic components. Based in Hongkong, we have already established firm and mutual-benefit business relationships with customers from,Europe,America and south Asia,supplying obsolete and hard-to-find components to meet their specific needs.

With the principle of “Quality Parts,Customers Priority,Honest Operation,and Considerate Service”,our business mainly focus on the distribution of electronic components. Line cards we deal with include Microchip,ALPS,ROHM,Xilinx,Pulse,ON,Everlight and Freescale. Main products comprise IC,Modules,Potentiometer,IC Socket,Relay,Connector.Our parts cover such applications as commercial,industrial, and automotives areas.

We are looking forward to setting up business relationship with you and hope to provide you with the best service and solution. Let us make a better world for our industry!



Contact us

Tel: +86-755-8981 8866 Fax: +86-755-8427 6832

Email & Skype: info@chipsmall.com Web: www.chipsmall.com

Address: A1208, Overseas Decoration Building, #122 Zhenhua RD., Futian, Shenzhen, China



NB2870A

Low Power, Reduced EMI Clock Synthesizer

The NB2870A is a versatile spread spectrum frequency modulator designed specifically for a wide range of clock frequencies. The NB2870A reduces ElectroMagnetic Interference (EMI) at the clock source, allowing system wide reduction of EMI of all clock dependent signals. The NB2870A allows significant system cost savings by reducing the number of circuit board layers, ferrite beads and shielding that are traditionally required to pass EMI regulations.

The NB2870A uses the most efficient and optimized modulation profile approved by the FCC and is implemented by using a proprietary all digital method.

The NB2870A modulates the output of a single PLL in order to “spread” the bandwidth of a synthesized clock, and more importantly, decreases the peak amplitudes of its harmonics. This results in significantly lower system EMI compared to the typical narrow band signal produced by oscillators and most frequency generators. Lowering EMI by increasing a signal’s bandwidth is called ‘spread spectrum clock generation’.

The NB2870A is targeted towards all portable devices with very low power requirements like MP3 players, Notebooks and digital still cameras.

Features

- Generates an EMI Optimized Clocking Signal at the Output
- Integrated Loop Filter Components
- Operates with a 3.3 V / 2.5 V Supply
- Operating Current less than 4.0 mA
- Low Power CMOS Design
- Input Frequency Range: 13 MHz to 30 MHz
- Generates a 1X Low EMI Spread Spectrum clock of the Input Frequency
- Frequency Deviation $\pm 0.75\%$ (TYP) @ 22 MHz
- Available in TSOP-6 Package (TSOT-23-6)
- Pb-Free Package is Available



ON Semiconductor®

<http://onsemi.com>

MARKING DIAGRAM*

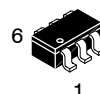

TSOP-6
(TSOT-23-6)
SN SUFFIX
CASE 318G

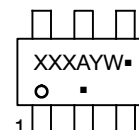

E09 = Specific Device Code
A = Assembly Location
Y = Year
W = Work Week
▪ = Pb-Free Package

(Note: Microdot may be in either location)

*For additional marking information, refer to Application Note AND8002/D.

ORDERING INFORMATION

See detailed ordering and shipping information in the package dimensions section on page 7 of this data sheet.

NB2870A

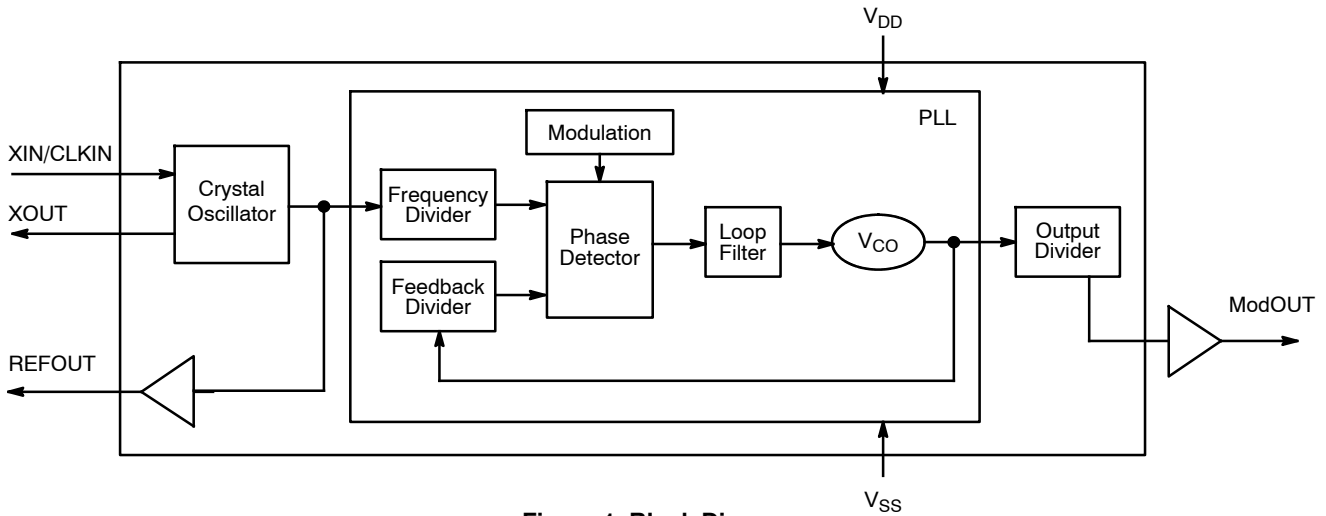

Figure 1. Block Diagram

Table 1. KEY SPECIFICATIONS

Description	Specification
Supply Voltages	$V_{DD} = 3.3 \text{ V} / 2.5 \text{ V}$
Frequency Range	$13 \text{ MHz} < \text{CLKIN} < 30 \text{ MHz}$
Cycle-to-Cycle Jitter	200 ps (maximum)
Output Duty Cycle	45/55% (worst case)
Modulation Equation	$F_{IN}/640$
Frequency Deviation	$\pm 0.75\%$ (TYP) @ 22 MHz

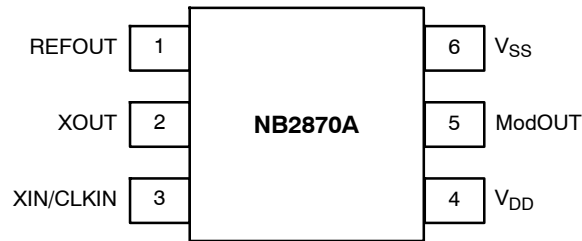

Figure 2. Pin Configuration

Table 2. PIN DESCRIPTION

Pin #	Pin Name	Type	Description
1	REFOUT	O	Buffered output of the input frequency.
2	XOUT	O	Crystal connection. If using an external reference, this pin must be left unconnected.
3	XIN/CLKIN	I	Crystal connection or external reference frequency input. This pin has dual functions. It can be connected either to an external crystal or an external reference clock
4	V_{DD}	P	Power supply for the entire chip.
5	ModOUT	O	Spread spectrum clock output.
6	V_{SS}	P	Ground connection.

NB2870A

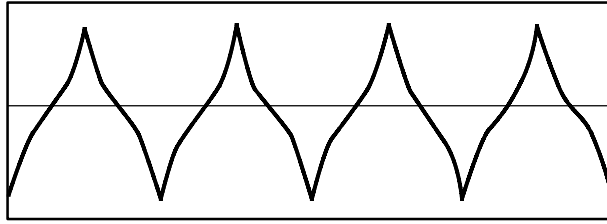

Figure 3. Modulation Profile

Table 3. MAXIMUM RATINGS

Symbol	Description	Rating	Unit
V_{DD}, V_{IN}	Voltage on any pin with respect to Ground	0.5 to + 7.0	V
T_{STG}	Storage Temperature	-65 to +125	°C
T_A	Operating Temperature	0 to 70	°C
T_s	Max. Soldering Temperature (10 sec)	260	°C
T_J	Junction Temperature	150	°C
T_{DV}	Static Discharge Voltage (As per MIL-STD-883, Method 3015)	2	kV

Stresses exceeding Maximum Ratings may damage the device. Maximum Ratings are stress ratings only. Functional operation above the Recommended Operating Conditions is not implied. Extended exposure to stresses above the Recommended Operating Conditions may affect device reliability.

NB2870A

Table 4. DC ELECTRICAL CHARACTERISTICS FOR 2.5 V SUPPLY (Test Conditions: All parameters are measured at room temperature 25°C)

Symbol	Description	Min	Typ	Max	Unit
V _{IL}	Input LOW Voltage	GND - 0.3		0.8	V
V _{IH}	Input HIGH Voltage	2.0		V _{DD} + 0.3	V
I _{IL}	Input LOW Current			-35	μA
I _{IH}	Input HIGH Current			35	μA
I _{XOL}	XOUT Output LOW Current (@ 0.5 V, V _{DD} = 2.5 V)		3.0		mA
I _{XOH}	XOUT Output HIGH Current (@ 1.8 V, V _{DD} = 2.5 V)		3.0		mA
V _{OL}	Output LOW Voltage (V _{DD} = 2.5 V, I _{OL} = 8.0 mA)			0.6	V
V _{OH}	Output HIGH Voltage (V _{DD} = 2.5 V, I _{OH} = 8.0 mA)	1.8			V
I _{DD}	Static Supply Current (Note 1)		1.0		mA
I _{CC}	Dynamic Supply Current (2.5 V, 22 MHz, and No Load)		3.0		mA
V _{DD}	Operating Voltage	2.375	2.5	2.625	V
t _{ON}	Powerup Time (first locked cycle after powerup) (Note 2)			5.0	mS
Z _{OUT}	Clock Output Impedance		50		Ω

NOTE: Device will meet the specifications after thermal equilibrium has been established when mounted in a test socket or printed circuit board with maintained transverse airflow greater than 500 lfm. Electrical parameters are guaranteed only over the declared operating temperature range. Functional operation of the device exceeding these conditions is not implied. Device specification limit values are applied individually under normal operating conditions and not valid simultaneously.

1. XIN/CLKIN pin is pulled low.
2. V_{DD} and XIN/CLKIN input are stable.

Table 5. AC ELECTRICAL CHARACTERISTICS FOR 2.5 V SUPPLY

Symbol	Description	Min	Typ	Max	Unit
CLKIN	Input Frequency	13		30	MHz
ModOUT	Output Frequency	13		30	MHz
f _d	Frequency Deviation Input Frequency = 13 MHz Input Frequency = 30 MHz			±1.20 ±0.47	%
t _{LH} (Note 3)	Output Rise Time (measured at 0.7 V to 1.7 V)	0.7	1.4	1.6	ns
t _{HL} (Note 3)	Output Fall Time (measured at 1.7 V to 0.7 V)	0.4	0.8	1.0	ns
t _{JC}	Jitter (Cycle-to-Cycle)			200	ps
t _D	Output Duty Cycle	45	50	55	%

NOTE: Device will meet the specifications after thermal equilibrium has been established when mounted in a test socket or printed circuit board with maintained transverse airflow greater than 500 lfm. Electrical parameters are guaranteed only over the declared operating temperature range. Functional operation of the device exceeding these conditions is not implied. Device specification limit values are applied individually under normal operating conditions and not valid simultaneously.

3. t_{LH} and t_{HL} are measured at capacitive load of 15 pF.

NB2870A

Table 6. DC ELECTRICAL CHARACTERISTICS FOR 3.3 V SUPPLY (Test Conditions: All parameters are measured at room temperature 25°C)

Symbol	Description	Min	Typ	Max	Unit
V _{IL}	Input LOW Voltage	GND - 0.3		0.8	V
V _{IH}	Input HIGH Voltage	2.0		V _{DD} + 0.3	V
I _{IL}	Input LOW Current			-35	μA
I _{IH}	Input HIGH Current			35	μA
I _{XOL}	XOUT Output LOW Current (@ 0.4 V, V _{DD} = 3.3 V)		3		mA
I _{XOH}	XOUT Output HIGH Current (@ 2.5 V, V _{DD} = 3.3 V)		3		mA
V _{OL}	Output LOW Voltage (V _{DD} = 3.3 V, I _{OL} = 8.0 mA)			0.4	V
V _{OH}	Output HIGH Voltage (V _{DD} = 3.3 V, I _{OH} = 8.0 mA)	2.5			V
I _{DD}	Static Supply Current (Note 4)		1.2		mA
I _{CC}	Dynamic Supply Current (3.3 V, 22 MHz, and No Load)		4.0		mA
V _{DD}	Operating Voltage	2.7	3.3	3.6	V
t _{ON}	Powerup Time (first locked cycle after powerup) (Note 5)			5.0	mS
Z _{OUT}	Clock Output Impedance		45		Ω

NOTE: Device will meet the specifications after thermal equilibrium has been established when mounted in a test socket or printed circuit board with maintained transverse airflow greater than 500 lfm. Electrical parameters are guaranteed only over the declared operating temperature range. Functional operation of the device exceeding these conditions is not implied. Device specification limit values are applied individually under normal operating conditions and not valid simultaneously.

4. XIN/CLKIN pin is pulled low.
5. V_{DD} and XIN/CLKIN input are stable.

Table 7. AC ELECTRICAL CHARACTERISTICS FOR 3.3 V SUPPLY

Symbol	Description	Min	Typ	Max	Unit
CLKIN	Input Frequency	13		30	MHz
ModOUT	Output Frequency	13		30	MHz
f _d	Frequency Deviation Input Frequency = 13 MHz Input Frequency = 30 MHz			±1.20 ±0.47	%
t _{LH} (Note 6)	Output Rise Time (measured at 0.8 V to 2.0 V)	0.4	1.2	1.5	ns
t _{HL} (Note 6)	Output Fall Time (measured at 2.0 V to 0.8 V)	0.3	0.8	1.1	ns
t _{JC}	Jitter (Cycle-to-Cycle)			200	ps
t _D	Output Duty Cycle	45	50	55	%

NOTE: Device will meet the specifications after thermal equilibrium has been established when mounted in a test socket or printed circuit board with maintained transverse airflow greater than 500 lfm. Electrical parameters are guaranteed only over the declared operating temperature range. Functional operation of the device exceeding these conditions is not implied. Device specification limit values are applied individually under normal operating conditions and not valid simultaneously.

6. t_{LH} and t_{HL} are measured at capacitive load of 15 pF.

NB2870A

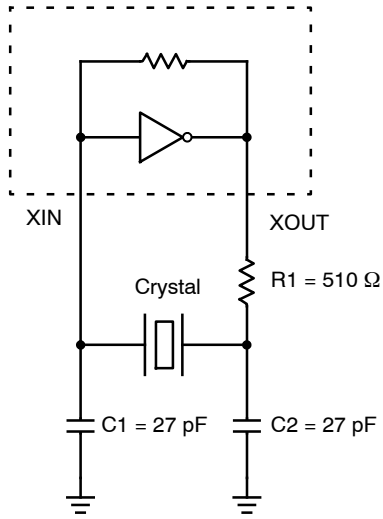

Figure 4. Typical Crystal Oscillator Circuit

Table 8. TYPICAL CRYSTAL SPECIFICATIONS

Fundamental AT Cut Parallel Resonant Crystal	
Nominal Frequency	14.31818 MHz
Frequency Tolerance	±50 ppm or better at 25°C
Operating Temperature Range	-25°C to +85°C
Storage Temperature	-40°C to +85°C
Load Capacitance	18 pF
Shunt Capacitance	7 pF Maximum
ESR	25 Ω

NB2870A

ORDERING INFORMATION

Device	Marking	Temperature Range	Package	Shipping [†]	Availability
NB2870ASNR2	E09	0°C - 70°C	TSOP-6 (TSOT-23-6)	2500 Tape & Reel	<i>Now</i>
NB2870ASNR2G	E09	0°C - 70°C	TSOP-6 (TSOT-23-6) (Pb-Free)	2500 Tape & Reel	<i>Contact Sales Representative</i>

[†]For information on tape and reel specifications, including part orientation and tape sizes, please refer to our Tape and Reel Packaging Specifications Brochure, BRD8011/D.

NB2870A

PACKAGE DIMENSIONS

TSOP-6 CASE 318G-02 ISSUE U

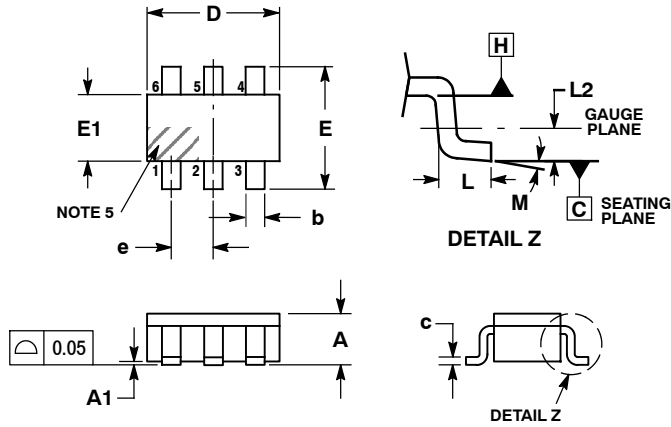

NOTES:

1. DIMENSIONING AND TOLERANCING PER ASME Y14.5M, 1994.
2. CONTROLLING DIMENSION: MILLIMETERS.
3. MAXIMUM LEAD THICKNESS INCLUDES LEAD FINISH. MINIMUM LEAD THICKNESS IS THE MINIMUM THICKNESS OF BASE MATERIAL.
4. DIMENSIONS D AND E1 DO NOT INCLUDE MOLD FLASH, PROTRUSIONS, OR GATE BURRS. MOLD FLASH, PROTRUSIONS, OR GATE BURRS SHALL NOT EXCEED 0.15 PER SIDE. DIMENSIONS D AND E1 ARE DETERMINED AT DATUM H.
5. PIN ONE INDICATOR MUST BE LOCATED IN THE INDICATED ZONE.

DIM	MILLIMETERS		
	MIN	NOM	MAX
A	0.90	1.00	1.10
A1	0.01	0.06	0.10
b	0.25	0.38	0.50
c	0.10	0.18	0.26
D	2.90	3.00	3.10
E	2.50	2.75	3.00
E1	1.30	1.50	1.70
e	0.85	0.95	1.05
L	0.20	0.40	0.60
L2	0.25 BSC		
M	0°	-	10°

RECOMMENDED SOLDERING FOOTPRINT*

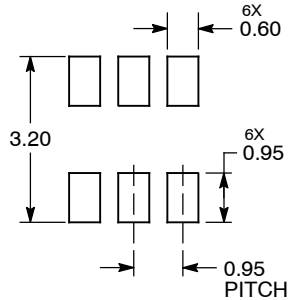

DIMENSIONS: MILLIMETERS

*For additional information on our Pb-Free strategy and soldering details, please download the ON Semiconductor Soldering and Mounting Techniques Reference Manual, SOLDERRM/D.

ON Semiconductor and are registered trademarks of Semiconductor Components Industries, LLC (SCILLC). SCILLC reserves the right to make changes without further notice to any products herein. SCILLC makes no warranty, representation or guarantee regarding the suitability of its products for any particular purpose, nor does SCILLC assume any liability arising out of the application or use of any product or circuit, and specifically disclaims any and all liability, including without limitation special, consequential or incidental damages. "Typical" parameters which may be provided in SCILLC data sheets and/or specifications can and do vary in different applications and actual performance may vary over time. All operating parameters, including "Typicals" must be validated for each customer application by customer's technical experts. SCILLC does not convey any license under its patent rights nor the rights of others. SCILLC products are not designed, intended, or authorized for use as components in systems intended for surgical implant into the body, or other applications intended to support or sustain life, or for any other application in which the failure of the SCILLC product could create a situation where personal injury or death may occur. Should Buyer purchase or use SCILLC products for any such unintended or unauthorized application, Buyer shall indemnify and hold SCILLC and its officers, employees, subsidiaries, affiliates, and distributors harmless against all claims, costs, damages, and expenses, and reasonable attorney fees arising out of, directly or indirectly, any claim of personal injury or death associated with such unintended or unauthorized use, even if such claim alleges that SCILLC was negligent regarding the design or manufacture of the part. SCILLC is an Equal Opportunity/Affirmative Action Employer. This literature is subject to all applicable copyright laws and is not for resale in any manner.

PUBLICATION ORDERING INFORMATION

LITERATURE FULFILLMENT:
Literature Distribution Center for ON Semiconductor
P.O. Box 5163, Denver, Colorado 80217 USA
Phone: 303-675-2175 or 800-344-3860 Toll Free USA/Canada
Fax: 303-675-2176 or 800-344-3867 Toll Free USA/Canada
Email: orderlit@onsemi.com

N. American Technical Support: 800-282-9855 Toll Free
USA/Canada
Europe, Middle East and Africa Technical Support:
Phone: 421 33 790 2910
Japan Customer Focus Center
Phone: 81-3-5773-3850

ON Semiconductor Website: www.onsemi.com
Order Literature: <http://www.onsemi.com/orderlit>

For additional information, please contact your local Sales Representative