



Chipsmall Limited consists of a professional team with an average of over 10 year of expertise in the distribution of electronic components. Based in Hongkong, we have already established firm and mutual-benefit business relationships with customers from,Europe,America and south Asia,supplying obsolete and hard-to-find components to meet their specific needs.

With the principle of “Quality Parts,Customers Priority,Honest Operation,and Considerate Service”,our business mainly focus on the distribution of electronic components. Line cards we deal with include Microchip,ALPS,ROHM,Xilinx,Pulse,ON,Everlight and Freescale. Main products comprise IC,Modules,Potentiometer,IC Socket,Relay,Connector.Our parts cover such applications as commercial,industrial, and automotives areas.

We are looking forward to setting up business relationship with you and hope to provide you with the best service and solution. Let us make a better world for our industry!



Contact us

Tel: +86-755-8981 8866 Fax: +86-755-8427 6832

Email & Skype: info@chipsmall.com Web: www.chipsmall.com

Address: A1208, Overseas Decoration Building, #122 Zhenhua RD., Futian, Shenzhen, China



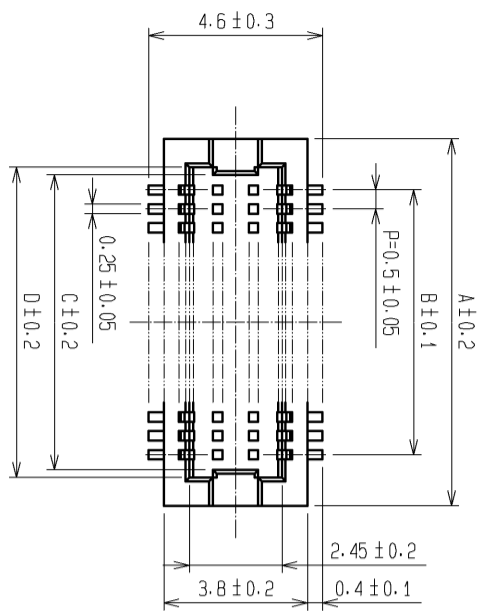

F-F (10:1)

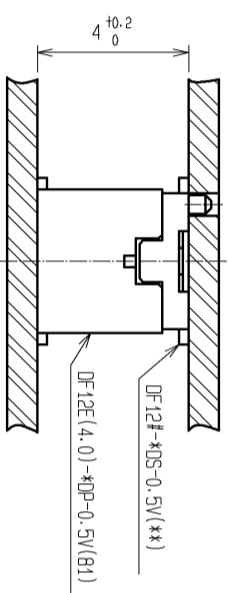
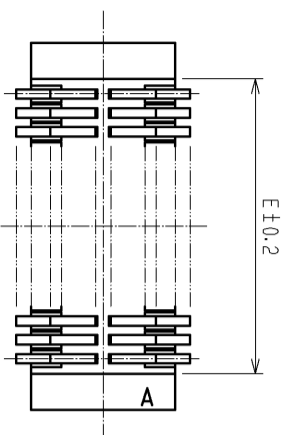
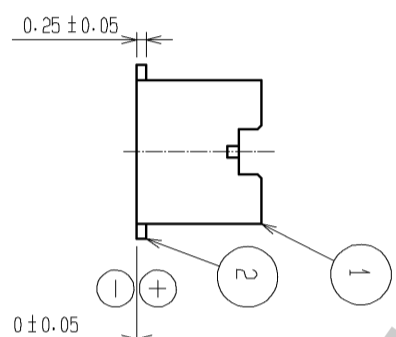
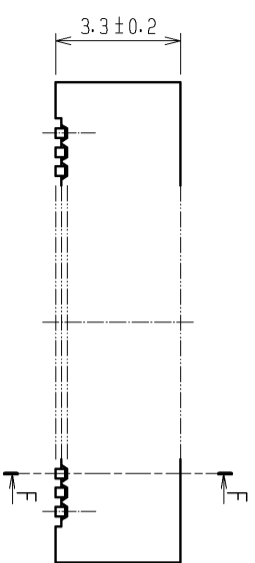
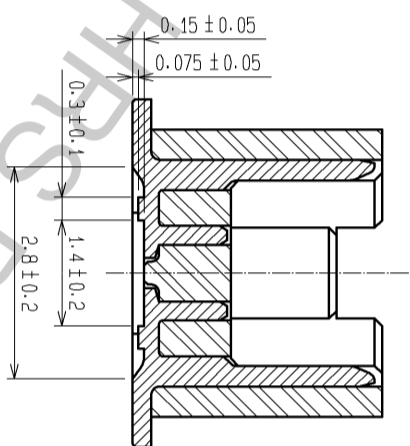

CODE NO.	CONTACT	A	B	C	D	E
CL537-0553-7-81	20	7.2	4.5	5.3	5.7	5.3
CL537-0555-2-81	30	9.7	7.0	7.8	8.2	7.8
CL537-0929-0-81	32	10.2	7.5	8.3	8.7	8.3
CL537-0556-5-81	36	11.2	8.5	9.3	9.7	9.3
CL537-0557-8-81	40	12.2	9.5	10.3	10.7	10.3
CL537-0559-3-81	50	14.7	12.0	12.8	13.2	12.8
CL537-0561-5-81	60	17.2	14.5	15.3	15.7	15.3

RECOMMEND METAL MASK PATTERN (10:1)

RECOMMENDED LAND PATTERN (10:1)

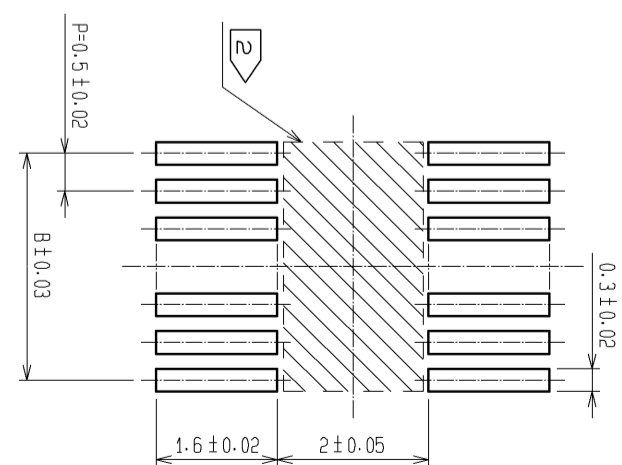
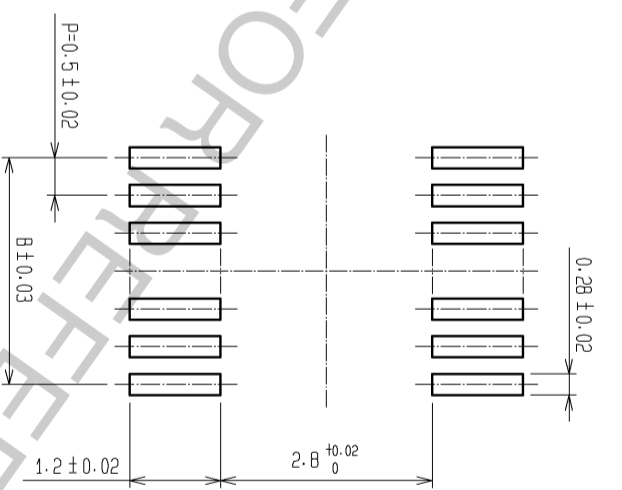

RECOMMENDED THICKNESS OF METAL MASK : 120 ÅM

RECOMMENDED THICKNESS OF SOLDER PASTE : 120 ÅM

NOTES 1 LEAD CO-PLANARITY SHALL BE 0.08 mm MAX.
 2 IF THERE IS PATTERN ON PART, THERE IS A POSSIBILITY THAT IT WILL MAKE CONTACT WITH THE LEADS.

NO.	MATERIAL	FINISH	REMARKS	NO.	MATERIAL	FINISH	REMARKS
1	POLYAMIDE	UL94V-0, NATURAL (BEIGE)		3	PS	CLEAR (EMBOSSED CARRIER TAPE)	
2	PHOSPHOR BRONZE	CONTACT AREA: GOLD PLATED 0.2µm min LEAD AREA: GOLD PLATED 0.015µm min OTHERS (UNDER PLATING): NICKEL PLATED 2µm min		4	PS	CLEAR (COVER TAPE)	
				5	PS	BLACK (PLASTIC REEL)	

UNITS	SCALE	COUNT	DESCRIPTION OF REVISIONS	DESIGNED	CHECKED	DATE
mm	5:1					

APPROVED	CHECKED	DESIGNED	DRAWN	DRAWING NO.	PART NO.	CODE
KH. IKEDA	YH. MICHIDA	YN. SAKAMOTO	YN. SAKAMOTO	12.04.17	12.04.16	12.04.13

EDC3-163513-77	DF12E(4.0)-*DP-0.5V(81)	CL537

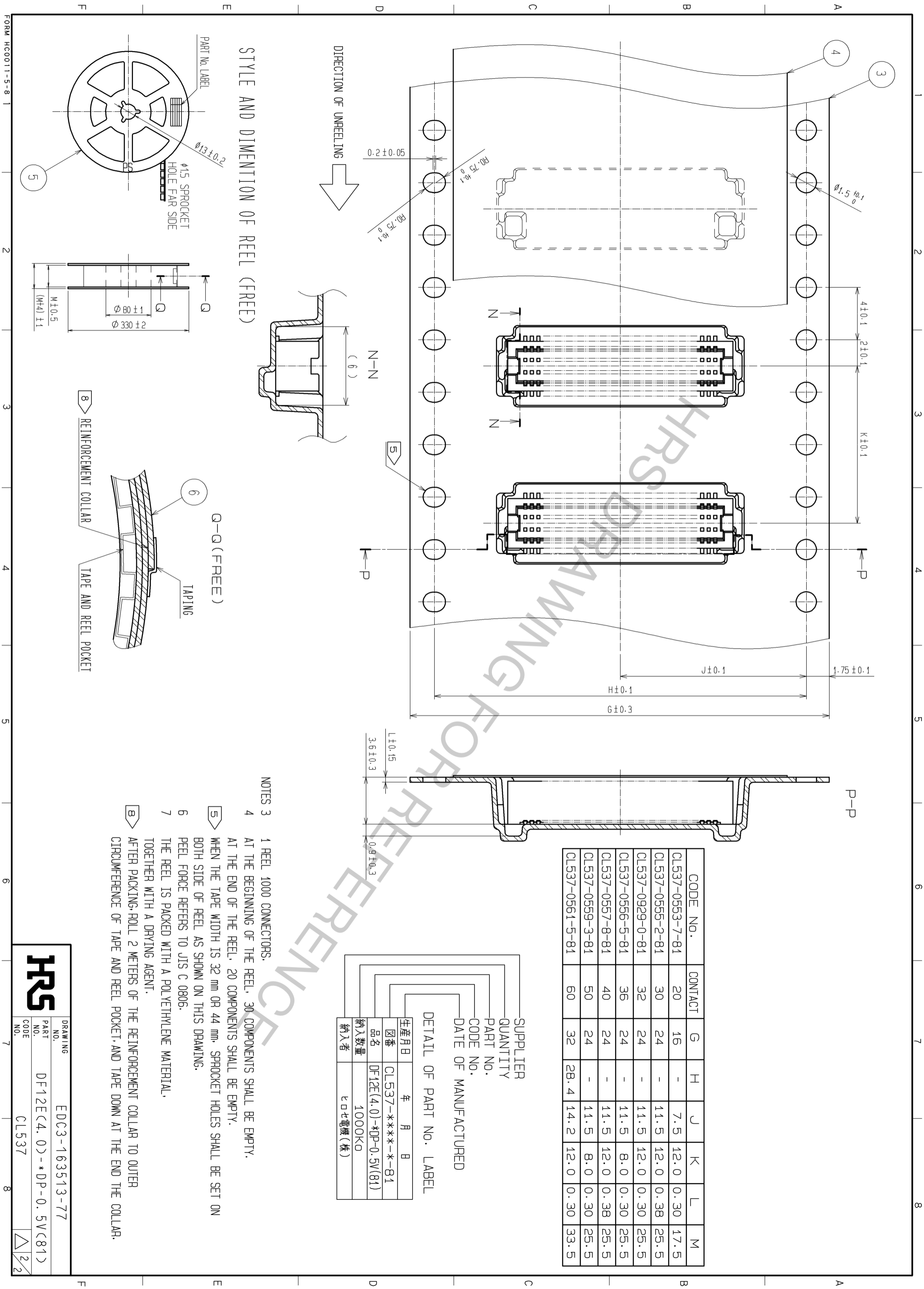

STYLE AND DIMENTION OF REEL (FREE)

DIRECTION OF UNREELING

Q-Q (FREE)

NOTES

- 1 REEL 1000 CONNECTORS.
- 2 AT THE BEGINNING OF THE REEL, 30 COMPONENTS SHALL BE EMPTY.
- 3 AT THE END OF THE REEL, 20 COMPONENTS SHALL BE EMPTY.
- 4 WHEN THE TAPE WIDTH IS 32 mm OR 44 mm, SPROCKET HOLES SHALL BE SET ON BOTH SIDE OF REEL AS SHOWN ON THIS DRAWING.
- 5 PEEL FORCE REFERS TO JIS C 0806.
- 6 THE REEL IS PACKED WITH A POLYETHYLENE MATERIAL.
- 7 TOGETHER WITH A DRYING AGENT.
- 8 AFTER PACKING, ROLL 2 METERS OF THE REINFORCEMENT COLLAR TO OUTER CIRCUMFERENCE OF TAPE AND REEL POCKET, AND TAPE DOWN AT THE END THE COLLAR.

CODE No.	CONTACT	G	H	J	K	L	M
CL537-0553-7-81	20	16	-	7.5	12.0	0.30	17.5
CL537-0555-2-81	30	24	-	11.5	12.0	0.38	25.5
CL537-0929-0-81	32	24	-	11.5	12.0	0.30	25.5
CL537-0556-5-81	36	24	-	11.5	8.0	0.30	25.5
CL537-0557-8-81	40	24	-	11.5	12.0	0.38	25.5
CL537-0559-3-81	50	24	-	11.5	8.0	0.30	25.5
CL537-0561-5-81	60	32	28.4	14.2	12.0	0.30	33.5

SUPPLIER
QUANTITY
PART NO.
CODE NO.
DATE OF MANUFACTURED

DETAIL OF PART NO. LABEL

生産月日	年	月	日
図番	CL537-***-*-81		
品名	DF12E(4.0)*DP-0.5V(81)		
納入数量	1000K0		
納入者	ヒロセ電機(株)		

HRS

DRAWING NO. EDC3-163513-77

PART NO. DF12E(4.0)*DP-0.5V(81)

CODE CL537

2/2