



Chipsmall Limited consists of a professional team with an average of over 10 year of expertise in the distribution of electronic components. Based in Hongkong, we have already established firm and mutual-benefit business relationships with customers from,Europe,America and south Asia,supplying obsolete and hard-to-find components to meet their specific needs.

With the principle of “Quality Parts,Customers Priority,Honest Operation,and Considerate Service”,our business mainly focus on the distribution of electronic components. Line cards we deal with include Microchip,ALPS,ROHM,Xilinx,Pulse,ON,Everlight and Freescale. Main products comprise IC,Modules,Potentiometer,IC Socket,Relay,Connector.Our parts cover such applications as commercial,industrial, and automotives areas.

We are looking forward to setting up business relationship with you and hope to provide you with the best service and solution. Let us make a better world for our industry!



Contact us

Tel: +86-755-8981 8866 Fax: +86-755-8427 6832

Email & Skype: info@chipsmall.com Web: www.chipsmall.com

Address: A1208, Overseas Decoration Building, #122 Zhenhua RD., Futian, Shenzhen, China



NCP1083QBCGEVB

Compact, high efficiency, 30 W Reference platform with the NCP1083 Evaluation Board User's Manual



ON Semiconductor®

<http://onsemi.com>

EVAL BOARD USER'S MANUAL

Board Details

The NCP1083QBCGEVB implements a PoE module that converts the power from the Ethernet cable to a lower voltage. The board also supports getting its power from an auxiliary input, in case PoE network is not available.

Warnings

Close to the switching MOSFET voltages on the board may exceed 200 V (@250 kHz). Temperature of board and its components may exceed 85°C during normal operation. The Evaluation board was designed to operate correctly under these conditions.

The input voltage should never exceed 57 V nor should the evaluation board be loaded with loads higher than the specified 30 W. Exceeding the specified input and output values could permanently damage the board.



Figure 1. Front Side of EVB

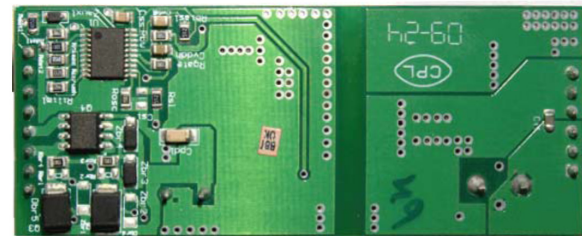

Figure 2. Back Side of EVB

Table 1. EVALUATION BOARD SPECIFICATIONS

Characteristic	Min	Typ	Max	Unit
Input Voltage, PoE Input	36	–	57	V
Input Voltage, Auxiliary Input	24	–	57	V
Output Voltage	–	12	–	V
Output Current	–	–	2.5	A
Oscillator Frequency	–	250	–	kHz
Output Ripple	–	–	170	mV
Efficiency	–	–	88	%

NCP1083QBCGEVB

Table 2. BOARD CONNECTOR DESCRIPTION

Connector	Pin	Description
P1	1	nClassAT, Notification Towards External Processor that IEEE802.3at, 2 nd Event Classification Has Completed
	2	Not Connected
	3	Vin, PoE, Pair 1
	4	Vin, PoE, Pair 1
	5	Vin, PoE, Pair 2
	6	Vin, PoE, Pair 2
	7	Vaux, Positive Auxiliary Input Supply
	8	Vaux_gnd, Auxiliary Input Supply Ground
Jout	1	12 V Regulated Output
	2	12 V Regulated Output
	3	12 V Regulated Output
	4	GND Regulated Output
	5	GND Regulated Output
	6	GND Regulated Output

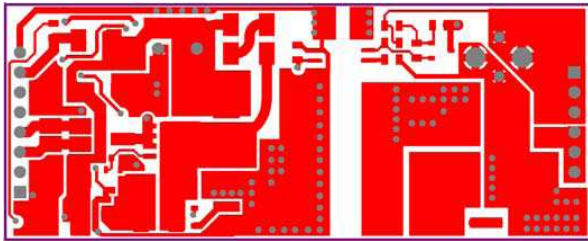

Figure 3. Layout Front

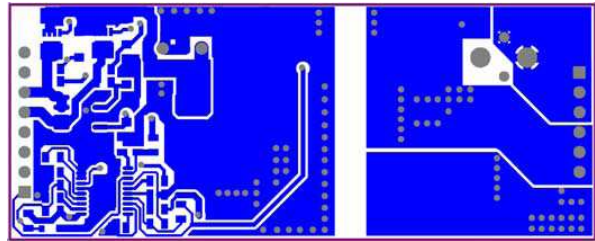

Figure 4. Layout Back

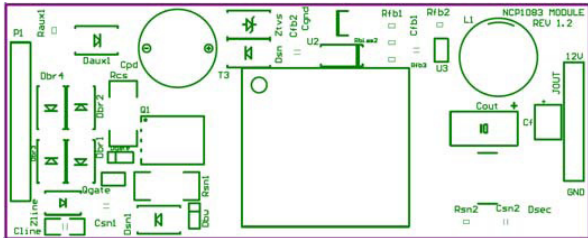

Figure 5. Silkscreen Front

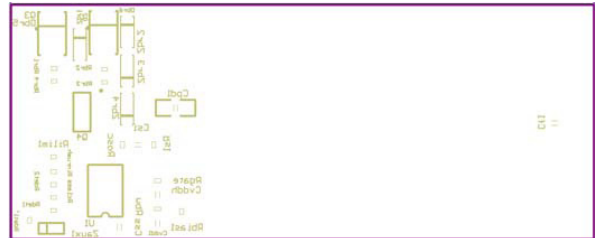

Figure 6. Silkscreen Back

NCP1083QBCGEVB

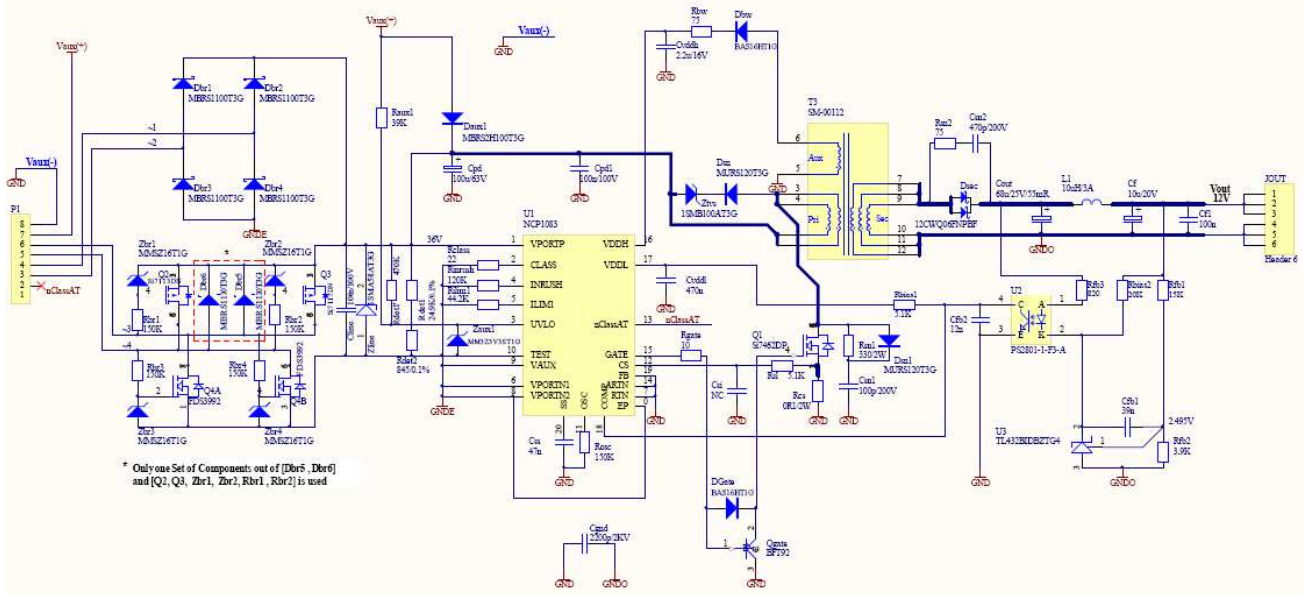

Figure 7. Schematic

Table 3. BILL OF MATERIALS

Designator	Quantity	Description	Value	Tolerance	Footprint	Manufacturer	Manufacturer Part Number	Substitution Allowed	Lead Free
U1	1	Power over Ethernet controller	NCP1083		TSSOPEP 20	ON Semiconductor	NCP1083DEG	No	Yes
Cf1	1	Capacitor SMD	0.1u/50V	10%	0805-C-S	Walsin	0805B104K500CT	Yes	Yes
Cline, Cpd1	2	Capacitor SMD	100n/100V	10%	1206-C	AVX	12061C104KAT2A	Yes	Yes
Csn1	1	Capacitor SMD	100p/200V	10%	0805-C-S	AVX	08052A101JAT2A	Yes	Yes
Cfb2	1	Capacitor SMD	12n/50V	10%	0805-C-S	AVX	08055C123KAT2A	Yes	Yes
Cvdh	1	Capacitor SMD	2.2u/16V	(+80%) to (-20%)	0805-C-S	AVX	0805YC225MAT2A	Yes	Yes
Cgnd	1	Capacitor SMD	2200p/2kV	10%	1812	Walsin	1812B222K202LT	Yes	Yes
Cfb1	1	Capacitor SMD	39n/50V	10%	0805-C-S	AVX	08055C393KAT2A	Yes	Yes
Cvddl	1	Capacitor SMD	470n/50V	10%	0805-C-S	AVX	08055C474KAZ2A	No	Yes
Csn2	1	Capacitor SMD	470p/200V	10%	0805-C-S	AVX	08052C47KJAT2A	Yes	Yes
Ccss	1	Capacitor SMD	47n/50V	10%	0805-C-S	AVX	08055C473KAT2A	Yes	Yes
Cpd	1	Electrolytic Capacitor	100u/63V	20%	CRD10.0L 17.0RM5.0	Hitano	EXR101M63	No	Yes
Cf	1	Capacitor Polar	10u/20V	10%	C-TANT-B	AVX	TAJB106K020R	Yes	Yes
Cout	1	Capacitor Polar	68u/25V/5 5mR	10%	C-TANT-E	AVX	TPME686K025R0055	No	Yes
T3	1	PoE Plus Transformer	SM-00112		EFD20	NUFLUX	SM-00112	No	Yes
Daux1	1	SMD Schottky Rectifier	MBRS2H100T3G		403A-03	ON Semiconductor	MBRS2H100T3G	No	Yes

NCP1083QBCGEVB

Table 3. BILL OF MATERIALS

Designator	Quantity	Description	Value	Tolerance	Footprint	Manufacturer	Manufacturer Part Number	Substitution Allowed	Lead Free
Dsn, Dsn1	2	SMD Ultrafast Rectifiers	MURS120 T3G		403A-03	ON Semiconductor	MURS120T3G	No	Yes
Dbr1, Dbr2, Dbr3, Dbr4, Dbr5, Dbr6,	6	SMD Schottky Rectifier	MBRS110 0T3G		403A-03	ON Semiconductor	MBRS1100T3G	No	Yes
Dbw, Dgate	2	SMD Switching Diode	BAS16HT 1G		SOD323	ON Semiconductor	BAS16HT1G	Yes	Yes
Dsec	1	SMD Schottky Rectifier	12CWQ06 FNPBF		DPAK	Vishay	12CWQ06FNPBF	No	Yes
Ztvs	1	SMD TVS Zener	1SMB100 AT3G		403A-03	ON Semiconductor / Multicomp	1SMB100AT3G / SMAJ58A	Yes	Yes
Zaux1	1	SMD Zener	MM3Z3V3 ST1G		SOD323	ON Semiconductor	MM3Z3V3ST1G	Yes	Yes
Zbr3, Zbr4	2	SMD Zener	MMSZ16T 1G		SOD123	ON Semiconductor	MMSZ16T1G	Yes	Yes
Zline	1	SMD TVS Zener	1SMA58A T3G		SMA	ON Semiconductor / Multicomp	1SMA58AT3G / SMAJ58A	Yes	Yes
JOUT	1	Header, 6-Pin	Header 6		HDR1X6	FCI	8614-00-36-1-Y0-10	Yes	Yes
P1	1	Header, 8-Pin	Header 8		HDR1X8	FCI	8614-00-36-1-Y0-10	Yes	Yes
L1	1	Drum Core Choke	10uH/3A		10X12	Prismatic	9404037403	No	Yes
Q1	1	MOSFET N-CHANNEL	Si7462DP		SOPP8	Vishay Siliconix	Si7462DP	No	Yes
Q4	1	MOSFET N-CHANNEL	FDS3992		SO-8	Fairchild	FDS3992	No	Yes
Qgate	1	Transistor PNP	BFT92		SOT23	Philips	BFT92	Yes	Yes
U2	1	HIGH ISOLATION VOLTAGE SSOP PHOTOCOUP LER	PS2801-1-F3-A		SSOP4	CEL	PS2801-1	No	Yes
U3	1	Programmable Shunt Voltage Reference	TL432BID BZTG4		SOT23	Texas-Instruments	TL432BIDBZTG4	No	Yes
Rcs	1	Resistor SMD	0.1/3W	1%	2512-S	Bourns	CRA2512-FZ-R100ELF	Yes	Yes
Rgate	1	Resistor SMD	10	1%	0805-R-S	Walsin	WR08X10R0FTL	Yes	Yes
Rinrush	1	Resistor SMD	121k	1%	0805-R-S	Walsin	WR08X1213FTL	Yes	Yes
Rbr3, Rbr4, Rosc	3	Resistor SMD	150k	1%	0805-R-S	Walsin	WR08X1503FTL	Yes	Yes
Rfb1	1	Resistor SMD	15k	1%	0805-R-S	Walsin	WR08X1502FTL	Yes	Yes
Rbias2	1	Resistor SMD	20k	1%	0805-R-S	Walsin	WR08X2002FTL	Yes	Yes
Rclass	1	Resistor SMD	30.1	1%	0805-R-S	Yageo	RC0805FR-0730R1L	Yes	Yes
Rdet1	1	Resistor SMD	24.9k	1%	0805-R-S	Walsin	WR08X2492FTL	Yes	Yes
Rfb2	1	Resistor SMD	3.92k	1%	0805-R-S	Walsin	WR08X3921FTL	Yes	Yes
Rsn1	1	Resistor SMD	330 /1W	5%	2512-S	Walsin	WR25X331JTL	Yes	Yes
Raux1	1	Resistor SMD	39.2k	1%	0805-R-S	Walsin	WR08X3922FTL	Yes	Yes
Rilim1	1	Resistor SMD	44.2K	1%	0805-R-S	Walsin	WR08X4422FTL	Yes	Yes
Rbias1, Rsl	2	Resistor SMD	5.1k	5%	0805-R-S	Walsin	WR08X512JTL	Yes	Yes

NCP1083QBCGEVB

Table 3. BILL OF MATERIALS

Designator	Quantity	Description	Value	Tolerance	Footprint	Manufacturer	Manufacturer Part Number	Substitution Allowed	Lead Free
Rbw, Rsn2	2	Resistor SMD	75	1%	0805-R-S	Walsin	WR08X750JTL	Yes	Yes
Rfb3	1	Resistor SMD	820	1%	0805-R-S	Yageo	RC0805FR-07820RL	Yes	Yes
Rdet2	1	Resistor SMD	845	1%	0805-R-S	Yageo	RC0805FR-07845RL	Yes	Yes
Rdet1	1	Resistor SMD	NC		0805-R-S				
Rbr1, Rbr2	2	Resistor SMD	NC	1%	0805-R-S				
Q2, Q3	2	P-Channel 30V (D-S) MOSFET	NC		POWERP ACK 1212-8	Vishay	Si7113		
Csi	1	Capacitor SMD	NC		0805-C-S				
Zbr1, Zbr2	2	SMD Zener	NC		SOD123	ON Semiconductor	MMSZ16T1G		

ON Semiconductor and  are registered trademarks of Semiconductor Components Industries, LLC (SCILLC). SCILLC reserves the right to make changes without further notice to any products herein. SCILLC makes no warranty, representation or guarantee regarding the suitability of its products for any particular purpose, nor does SCILLC assume any liability arising out of the application or use of any product or circuit, and specifically disclaims any and all liability, including without limitation special, consequential or incidental damages. "Typical" parameters which may be provided in SCILLC data sheets and/or specifications can and do vary in different applications and actual performance may vary over time. All operating parameters, including "Typicals" must be validated for each customer application by customer's technical experts. SCILLC does not convey any license under its patent rights nor the rights of others. SCILLC products are not designed, intended, or authorized for use as components in systems intended for surgical implant into the body, or other applications intended to support or sustain life, or for any other application in which the failure of the SCILLC product could create a situation where personal injury or death may occur. Should Buyer purchase or use SCILLC products for any such unintended or unauthorized application, Buyer shall indemnify and hold SCILLC and its officers, employees, subsidiaries, affiliates, and distributors harmless against all claims, costs, damages, and expenses, and reasonable attorney fees arising out of, directly or indirectly, any claim of personal injury or death associated with such unintended or unauthorized use, even if such claim alleges that SCILLC was negligent regarding the design or manufacture of the part. SCILLC is an Equal Opportunity/Affirmative Action Employer. This literature is subject to all applicable copyright laws and is not for resale in any manner.

PUBLICATION ORDERING INFORMATION

LITERATURE FULFILLMENT:
 Literature Distribution Center for ON Semiconductor
 P.O. Box 5163, Denver, Colorado 80217 USA
Phone: 303-675-2175 or 800-344-3860 Toll Free USA/Canada
Fax: 303-675-2176 or 800-344-3867 Toll Free USA/Canada
Email: orderlit@onsemi.com

N. American Technical Support: 800-282-9855 Toll Free
 USA/Canada
Europe, Middle East and Africa Technical Support:
 Phone: 421 33 790 2910
Japan Customer Focus Center
 Phone: 81-3-5817-1050

ON Semiconductor Website: www.onsemi.com
Order Literature: <http://www.onsemi.com/orderlit>

For additional information, please contact your local Sales Representative