



Chipsmall Limited consists of a professional team with an average of over 10 year of expertise in the distribution of electronic components. Based in Hongkong, we have already established firm and mutual-benefit business relationships with customers from,Europe,America and south Asia,supplying obsolete and hard-to-find components to meet their specific needs.

With the principle of “Quality Parts,Customers Priority,Honest Operation,and Considerate Service”,our business mainly focus on the distribution of electronic components. Line cards we deal with include Microchip,ALPS,ROHM,Xilinx,Pulse,ON,Everlight and Freescale. Main products comprise IC,Modules,Potentiometer,IC Socket,Relay,Connector.Our parts cover such applications as commercial,industrial, and automotives areas.

We are looking forward to setting up business relationship with you and hope to provide you with the best service and solution. Let us make a better world for our industry!



Contact us

Tel: +86-755-8981 8866 Fax: +86-755-8427 6832

Email & Skype: info@chipsmall.com Web: www.chipsmall.com

Address: A1208, Overseas Decoration Building, #122 Zhenhua RD., Futian, Shenzhen, China



NCP160

250 mA, Ultra-Low Noise and High PSRR LDO Regulator for RF and Analog Circuits

The NCP160 is a linear regulator capable of supplying 250 mA output current. Designed to meet the requirements of RF and analog circuits, the NCP160 device provides low noise, high PSRR, low quiescent current, and very good load/line transients. The device is designed to work with a 1 μF input and a 1 μF output ceramic capacitor. It is available in two thickness ultra-small 0.35P, 0.65 mm x 0.65 mm Chip Scale Package (CSP) and XDFN-4 0.65P, 1 mm x 1 mm.

Features

- Operating Input Voltage Range: 1.9 V to 5.5 V
- Available in Fixed Voltage Option: 1.8 V to 5.14 V
- $\pm 2\%$ Accuracy Over Load/Temperature
- Ultra Low Quiescent Current Typ. 18 μA
- Standby Current: Typ. 0.1 μA
- Very Low Dropout: 80 mV at 250 mA
- Ultra High PSRR: Typ. 98 dB at 20 mA, $f = 1$ kHz
- Ultra Low Noise: 10 μVRMS
- Stable with a 1 μF Small Case Size Ceramic Capacitors
- Available in –WLCSP4 0.65 mm x 0.65 mm x 0.4 mm
–WLCSP4 0.65 mm x 0.65 mm x 0.33 mm
–XDFN4 1 mm x 1 mm x 0.4 mm
- These Devices are Pb-Free, Halogen Free/BFR Free and are RoHS Compliant

Typical Applications

- Battery-powered Equipment
- Wireless LAN Devices
- Smartphones, Tablets
- Cameras, DVRs, STB and Camcorders

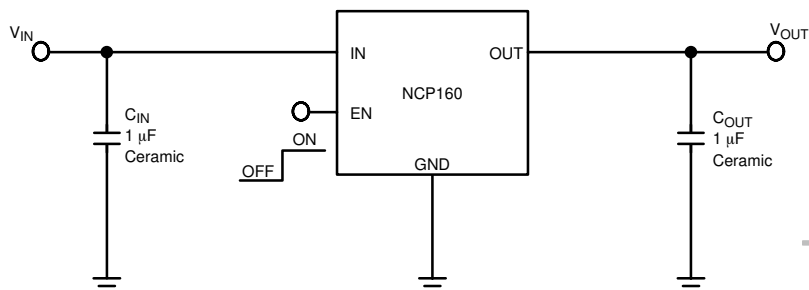

Figure 1. Typical Application Schematics



ON Semiconductor®

www.onsemi.com

MARKING DIAGRAMS

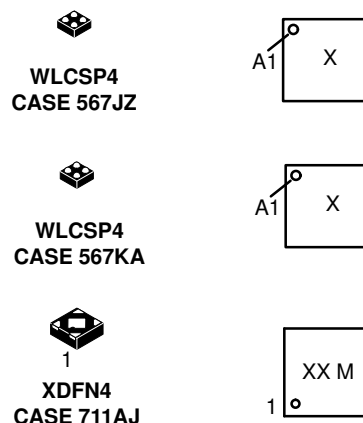

X or XX = Specific Device Code
M = Date Code

PIN CONNECTIONS

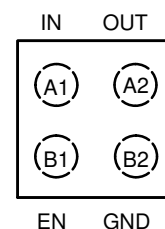

(Top View)

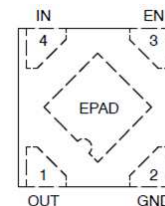

(Top View)

ORDERING INFORMATION

See detailed ordering, marking and shipping information on page 16 of this data sheet.

NCP160

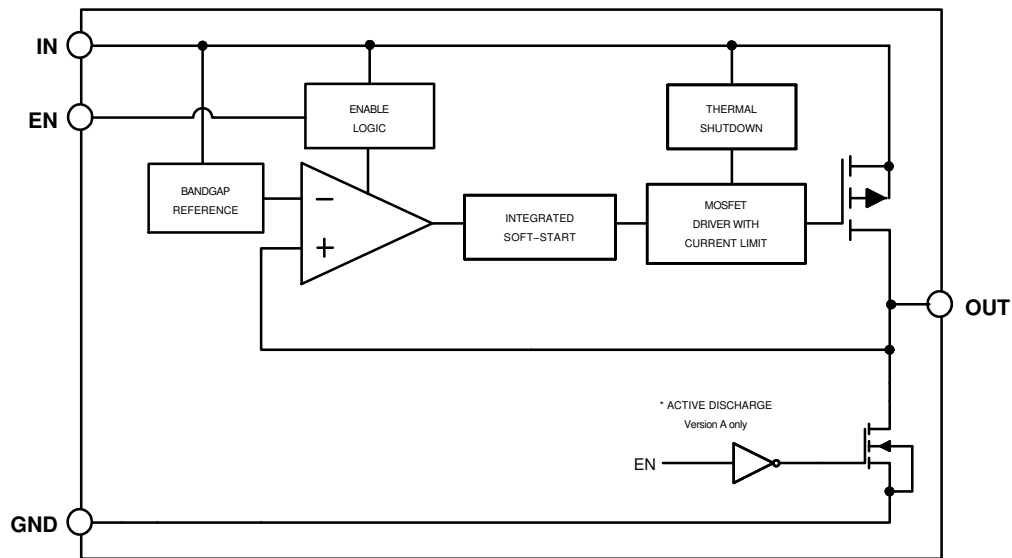

Figure 2. Simplified Schematic Block Diagram

PIN FUNCTION DESCRIPTION

Pin No. CSP4	Pin No. XDFN4	Pin Name	Description
A1	4	IN	Input voltage supply pin
A2	1	OUT	Regulated output voltage. The output should be bypassed with small 1 μ F ceramic capacitor.
B1	3	EN	Chip enable: Applying $V_{EN} < 0.4$ V disables the regulator, Pulling $V_{EN} > 1.2$ V enables the LDO.
B2	2	GND	Common ground connection
-	EPAD	EPAD	Expose pad can be tied to ground plane for better power dissipation

ABSOLUTE MAXIMUM RATINGS

Rating	Symbol	Value	Unit
Input Voltage (Note 1)	V_{IN}	-0.3 V to 6	V
Output Voltage	V_{OUT}	-0.3 to $V_{IN} + 0.3$, max. 6 V	V
Chip Enable Input	V_{CE}	-0.3 to $V_{IN} + 0.3$, max. 6 V	V
Output Short Circuit Duration	t_{SC}	unlimited	s
Maximum Junction Temperature	T_J	150	$^{\circ}$ C
Storage Temperature	T_{STG}	-55 to 150	$^{\circ}$ C
ESD Capability, Human Body Model (Note 2)	ESD_{HBM}	2000	V
ESD Capability, Machine Model (Note 2)	ESD_{MM}	200	V

Stresses exceeding those listed in the Maximum Ratings table may damage the device. If any of these limits are exceeded, device functionality should not be assumed, damage may occur and reliability may be affected.

1. Refer to ELECTRICAL CHARACTERISTICS and APPLICATION INFORMATION for Safe Operating Area.

2. This device series incorporates ESD protection and is tested by the following methods:

ESD Human Body Model tested per EIA/JESD22-A114

ESD Machine Model tested per EIA/JESD22-A115

Latchup Current Maximum Rating tested per JEDEC standard: JESD78.

THERMAL CHARACTERISTICS

Rating	Symbol	Value	Unit
Thermal Characteristics, CSP4 (Note 3) Thermal Resistance, Junction-to-Air	$R_{\theta JA}$	108	$^{\circ}$ C/W
Thermal Characteristics, XDFN4 (Note 3) Thermal Resistance, Junction-to-Air		198.1	

3. Measured according to JEDEC board specification. Detailed description of the board can be found in JESD51-7

NCP160

ELECTRICAL CHARACTERISTICS $-40^{\circ}\text{C} \leq T_J \leq 125^{\circ}\text{C}$; $V_{IN} = V_{OUT(NOM)} + 1\text{ V}$; $I_{OUT} = 1\text{ mA}$, $C_{IN} = C_{OUT} = 1\text{ }\mu\text{F}$, unless otherwise noted. $V_{EN} = 1.2\text{ V}$. Typical values are at $T_J = +25^{\circ}\text{C}$ (Note 4).

Parameter	Test Conditions		Symbol	Min	Typ	Max	Unit
Operating Input Voltage			V_{IN}	1.9		5.5	V
Output Voltage Accuracy	$V_{IN} = V_{OUT(NOM)} + 1\text{ V}$ $0\text{ mA} \leq I_{OUT} \leq 250\text{ mA}$		V_{OUT}	-2		+2	%
Line Regulation	$V_{OUT(NOM)} + 1\text{ V} \leq V_{IN} \leq 5.5\text{ V}$		$Line_{Reg}$		0.02		%/V
Load Regulation	$I_{OUT} = 1\text{ mA to } 250\text{ mA}$		$Load_{Reg}$		0.001		%/mA
Dropout Voltage (Note 5)	$I_{OUT} = 250\text{ mA}$	$V_{OUT(NOM)} = 1.8\text{ V}$	V_{DO}		180	250	mV
		$V_{OUT(NOM)} = 2.5\text{ V}$			110	175	
		$V_{OUT(NOM)} = 2.8\text{ V}$			95	160	
		$V_{OUT(NOM)} = 2.85\text{ V}$			95	160	
		$V_{OUT(NOM)} = 3.0\text{ V}$			90	155	
		$V_{OUT(NOM)} = 3.2\text{ V}$			85	149	
		$V_{OUT(NOM)} = 3.3\text{ V}$			80	145	
		$V_{OUT(NOM)} = 3.5\text{ V}$			75	140	
		$V_{OUT(NOM)} = 4.5\text{ V}$			65	120	
		$V_{OUT(NOM)} = 5.0\text{ V}$			75	105	
$V_{OUT(NOM)} = 5.14\text{ V}$		60	105				
Output Current Limit	$V_{OUT} = 90\% V_{OUT(NOM)}$		I_{CL}	250	700		mA
Short Circuit Current	$V_{OUT} = 0\text{ V}$		I_{SC}		690		
Quiescent Current	$I_{OUT} = 0\text{ mA}$		I_Q		18	23	μA
Shutdown Current	$V_{EN} \leq 0.4\text{ V}$, $V_{IN} = 4.8\text{ V}$		I_{DIS}		0.01	1	μA
EN Pin Threshold Voltage	EN Input Voltage "H"		V_{ENH}	1.2			V
	EN Input Voltage "L"		V_{ENL}			0.4	
EN Pull Down Current	$V_{EN} = 4.8\text{ V}$		I_{EN}		0.2	0.5	μA
Turn-On Time	$C_{OUT} = 1\text{ }\mu\text{F}$, From assertion of V_{EN} to $V_{OUT} = 95\% V_{OUT(NOM)}$				120		μs
Power Supply Rejection Ratio	$I_{OUT} = 20\text{ mA}$	$f = 100\text{ Hz}$ $f = 1\text{ kHz}$ $f = 10\text{ kHz}$ $f = 100\text{ kHz}$	PSRR		91 98 82 48		dB
Output Voltage Noise	$f = 10\text{ Hz to } 100\text{ kHz}$	$I_{OUT} = 1\text{ mA}$ $I_{OUT} = 250\text{ mA}$	V_N		14 10		μV_{RMS}
Thermal Shutdown Threshold	Temperature rising		T_{SDH}		160		$^{\circ}\text{C}$
	Temperature falling		T_{SDL}		140		$^{\circ}\text{C}$
Active Output Discharge Resistance	$V_{EN} < 0.4\text{ V}$, Version A only		R_{DIS}		280		Ω
Line Transient (Note 6)	$V_{IN} = (V_{OUT(NOM)} + 1\text{ V})$ to $(V_{OUT(NOM)} + 1.6\text{ V})$ in $30\text{ }\mu\text{s}$, $I_{OUT} = 1\text{ mA}$		$Tran_{LINE}$	-1			mV
	$V_{IN} = (V_{OUT(NOM)} + 1.6\text{ V})$ to $(V_{OUT(NOM)} + 1\text{ V})$ in $30\text{ }\mu\text{s}$, $I_{OUT} = 1\text{ mA}$					+1	
Load Transient (Note 6)	$I_{OUT} = 1\text{ mA to } 200\text{ mA}$ in $10\text{ }\mu\text{s}$		$Tran_{LOAD}$	-40			mV
	$I_{OUT} = 200\text{ mA to } 1\text{ mA}$ in $10\text{ }\mu\text{s}$					+40	

Product parametric performance is indicated in the Electrical Characteristics for the listed test conditions, unless otherwise noted. Product performance may not be indicated by the Electrical Characteristics if operated under different conditions.

4. Performance guaranteed over the indicated operating temperature range by design and/or characterization. Production tested at $T_A = 25^{\circ}\text{C}$.

Low duty cycle pulse techniques are used during the testing to maintain the junction temperature as close to ambient as possible.

5. Dropout voltage is characterized when V_{OUT} falls 100 mV below $V_{OUT(NOM)}$.

6. Guaranteed by design.

NCP160

TYPICAL CHARACTERISTICS

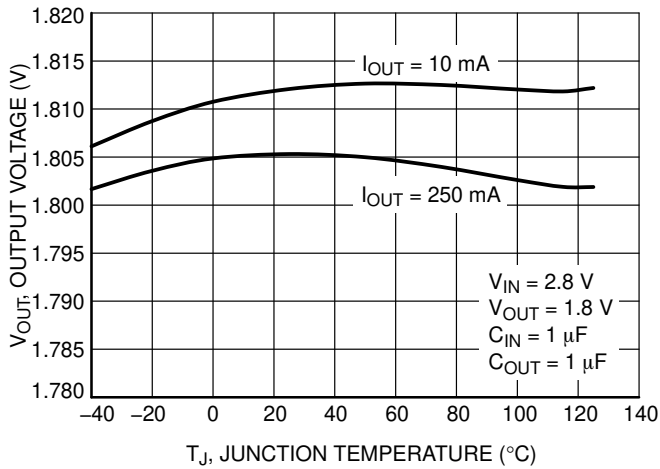

Figure 3. Output Voltage vs. Temperature – $V_{OUT} = 1.8\text{ V}$ – XDFN Package

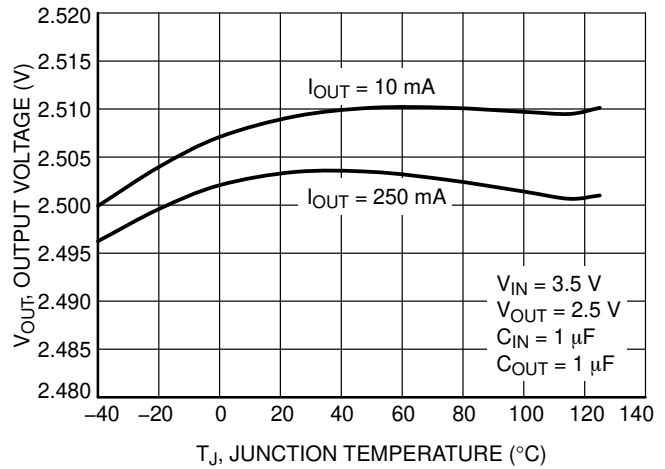

Figure 4. Output Voltage vs. Temperature – $V_{OUT} = 2.5\text{ V}$ – XDFN Package

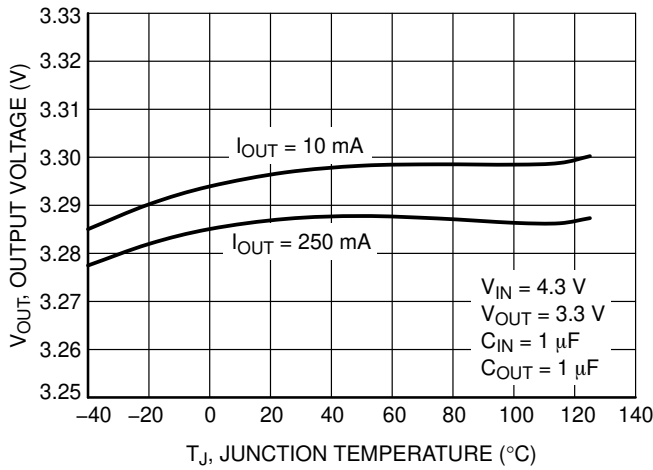

Figure 5. Output Voltage vs. Temperature – $V_{OUT} = 3.3\text{ V}$ – XDFN Package

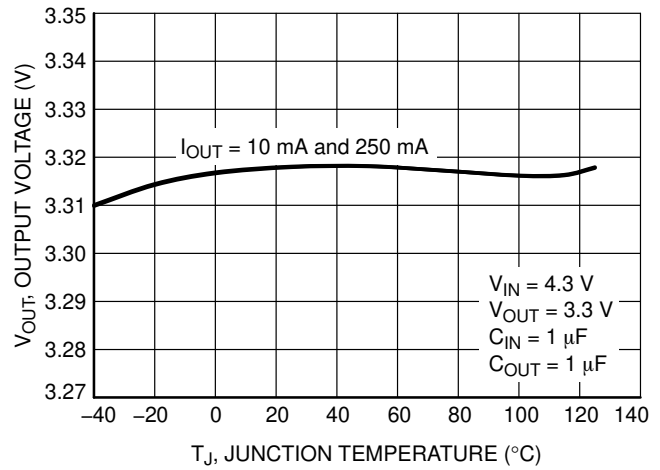

Figure 6. Output Voltage vs. Temperature – $V_{OUT} = 3.3\text{ V}$ – CSP Package

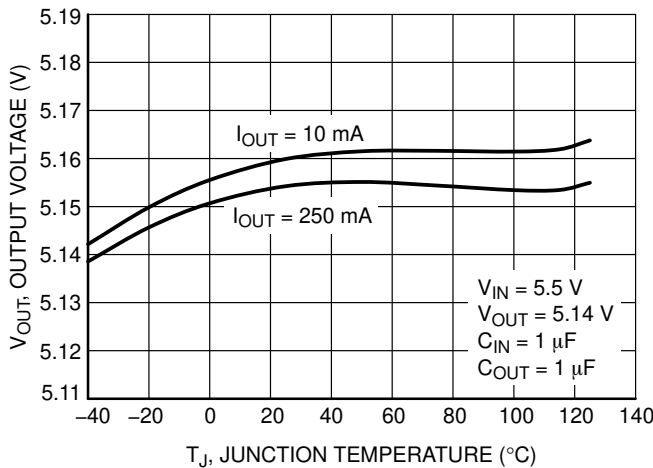

Figure 7. Output Voltage vs. Temperature – $V_{OUT} = 5.14\text{ V}$ – XDFN Package

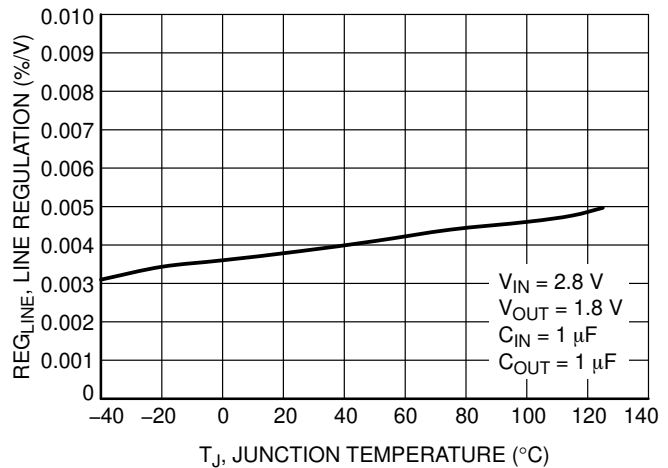

Figure 8. Line Regulation vs. Temperature – $V_{OUT} = 1.8\text{ V}$

NCP160

TYPICAL CHARACTERISTICS

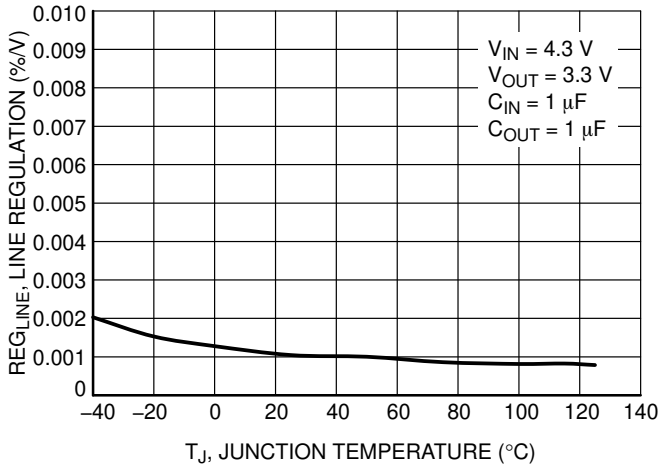

Figure 9. Line Regulation vs. Temperature – $V_{OUT} = 3.3\text{ V}$

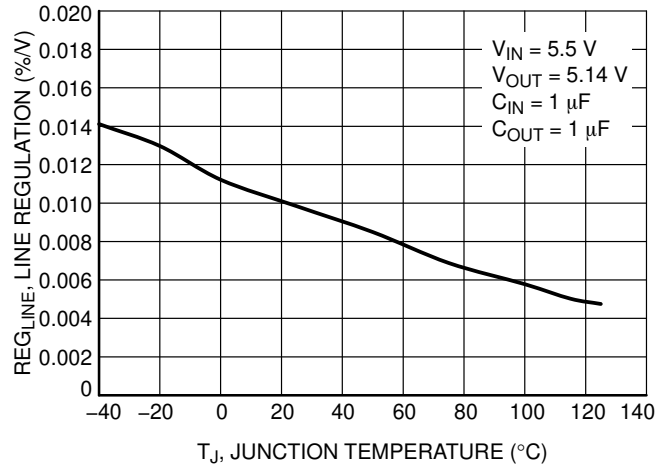

Figure 10. Line Regulation vs. Temperature – $V_{OUT} = 5.14\text{ V}$

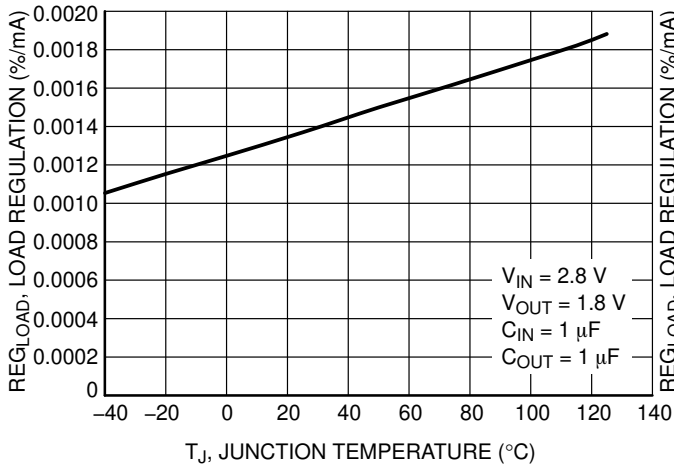

Figure 11. Load Regulation vs. Temperature – $V_{OUT} = 1.8\text{ V}$

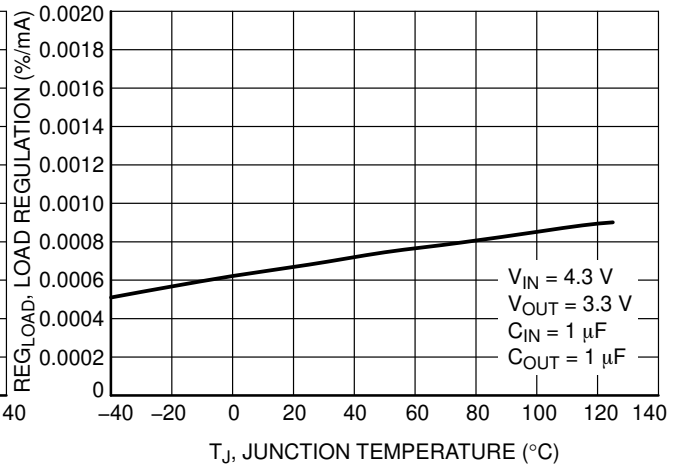

Figure 12. Load Regulation vs. Temperature – $V_{OUT} = 3.3\text{ V}$

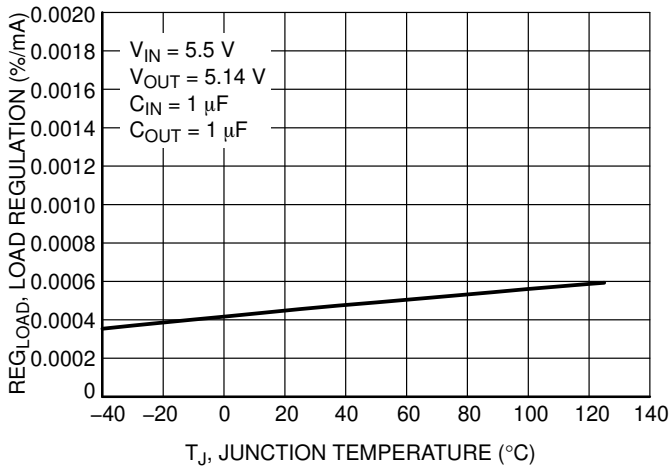

Figure 13. Load Regulation vs. Temperature – $V_{OUT} = 5.14\text{ V}$

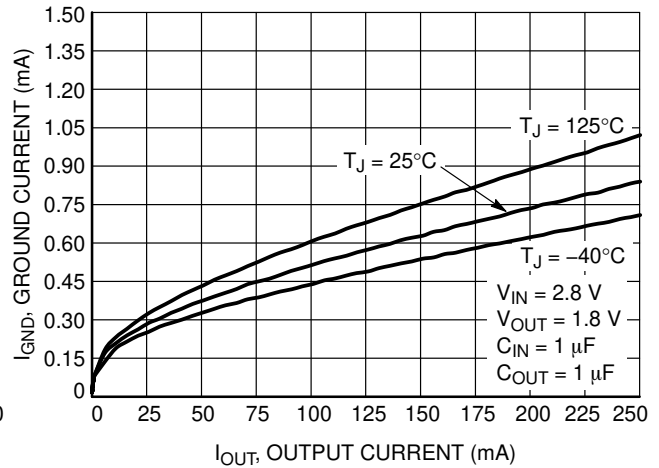

Figure 14. Ground Current vs. Load Current – $V_{OUT} = 1.8\text{ V}$

NCP160

TYPICAL CHARACTERISTICS

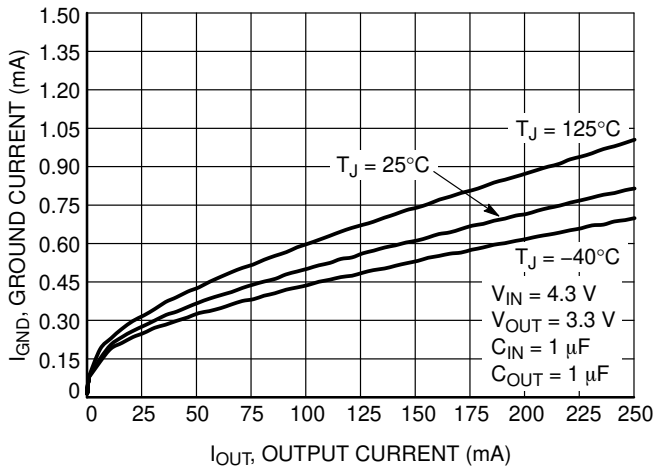

Figure 15. Ground Current vs. Load Current – $V_{OUT} = 3.3\text{ V}$

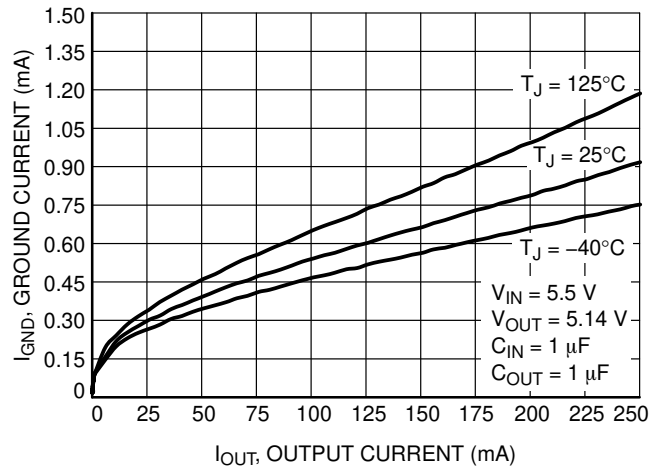

Figure 16. Ground Current vs. Load Current – $V_{OUT} = 5.14\text{ V}$

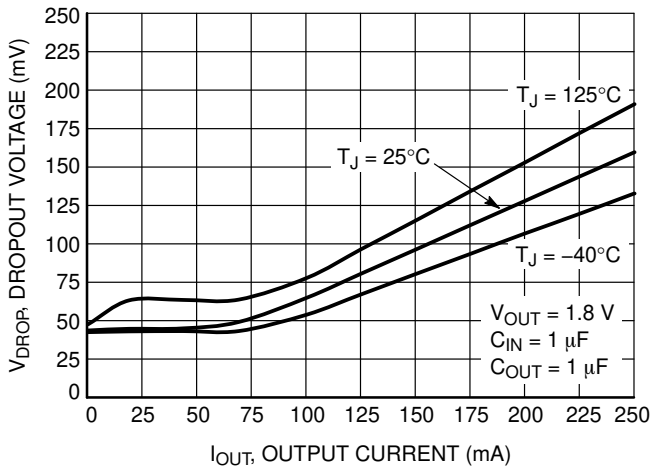

Figure 17. Dropout Voltage vs. Load Current – $V_{OUT} = 1.8\text{ V}$

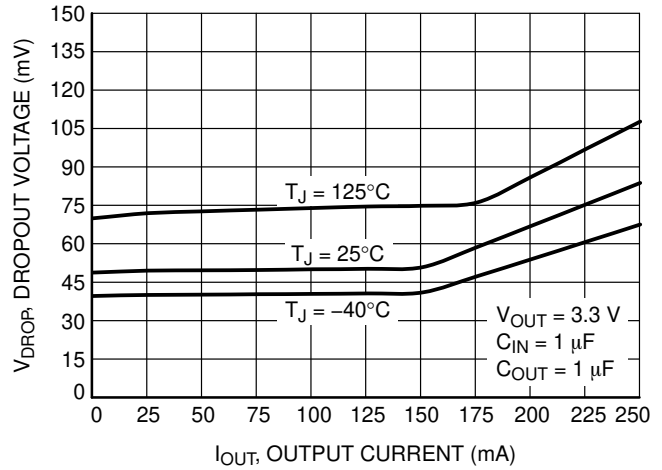

Figure 18. Dropout Voltage vs. Load Current – $V_{OUT} = 3.3\text{ V}$

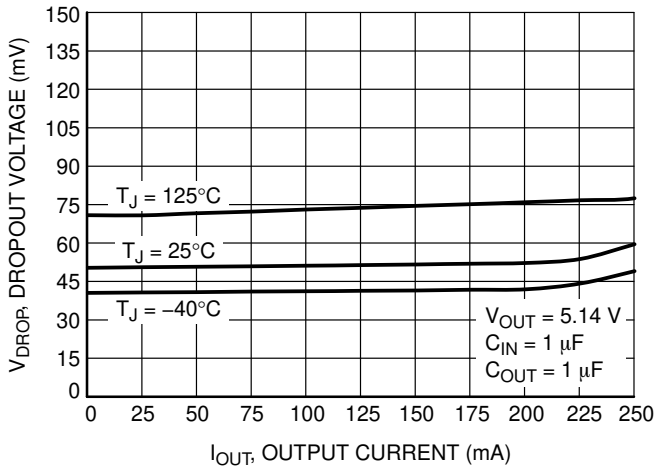

Figure 19. Dropout Voltage vs. Load Current – $V_{OUT} = 5.14\text{ V}$

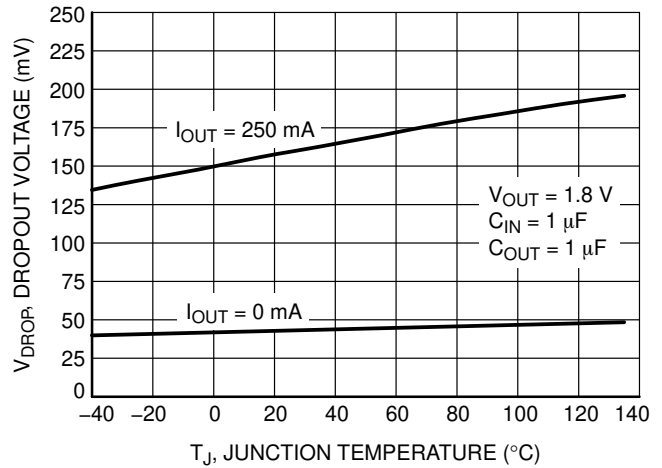

Figure 20. Dropout Voltage vs. Temperature – $V_{OUT} = 1.8\text{ V}$

NCP160

TYPICAL CHARACTERISTICS

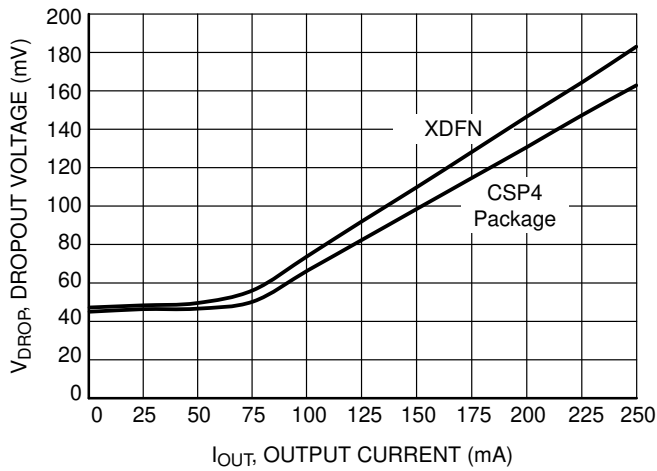

Figure 21. Comparison Dropout for XDFN and CSP – 1.8 V

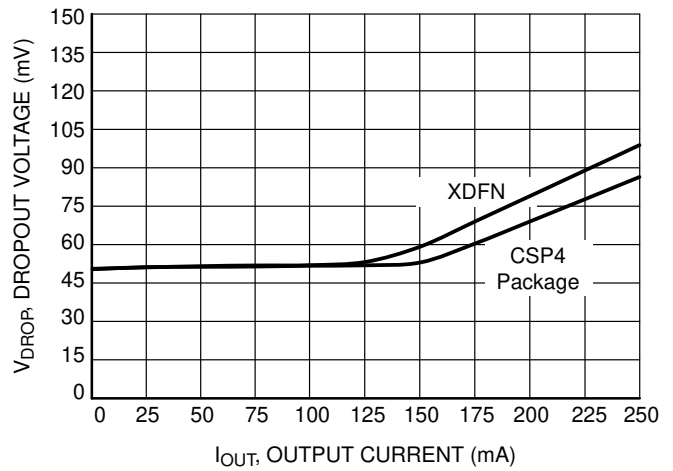

Figure 22. Comparison Dropout for XDFN and CSP – 3.3 V

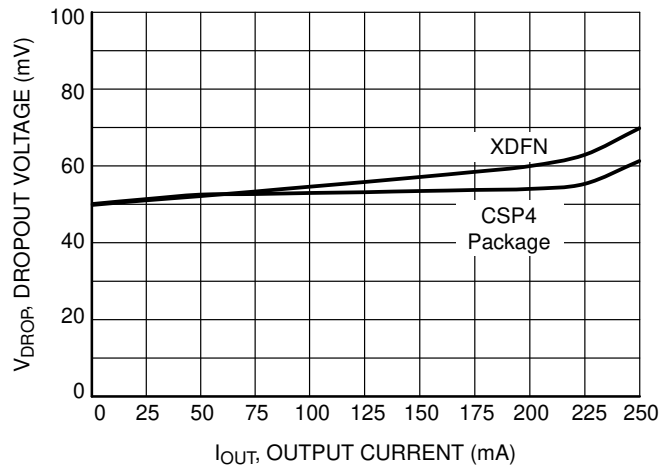
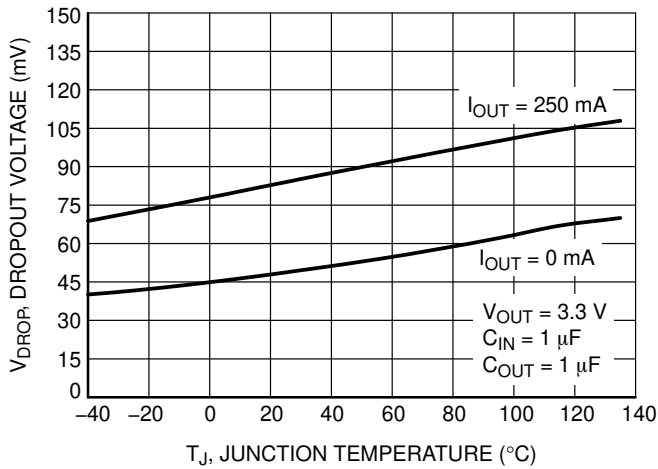

Figure 23. Comparison Dropout for XDFN and CSP – 5.14 V

NCP160

TYPICAL CHARACTERISTICS



**Figure 24. Dropout Voltage vs. Temperature—
V_{OUT} = 3.3 V**

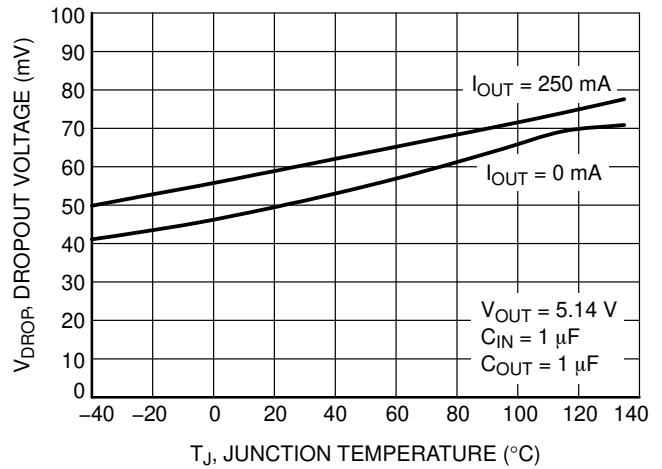

**Figure 25. Dropout Voltage vs. Temperature—
V_{OUT} = 5.14 V**

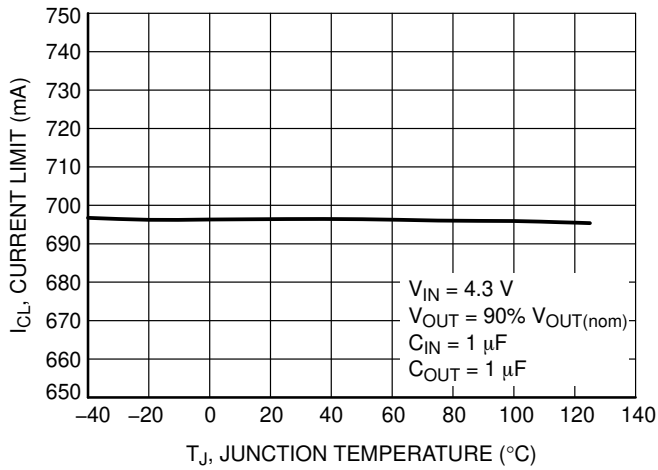
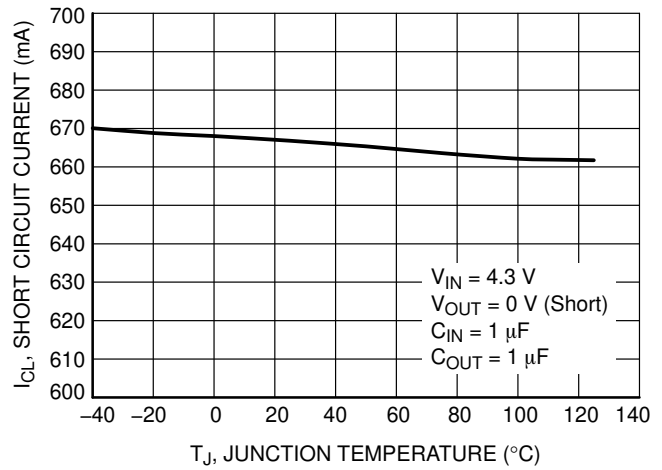
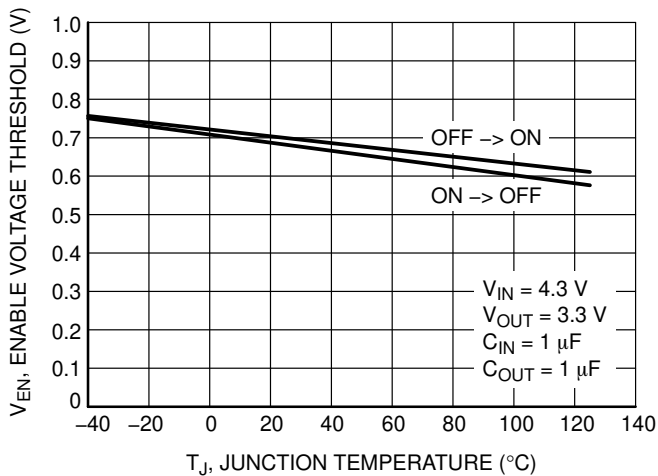

Figure 26. Current Limit vs. Temperature



**Figure 27. Short Circuit Current vs.
Temperature**



**Figure 28. Enable Threshold Voltage vs.
Temperature**

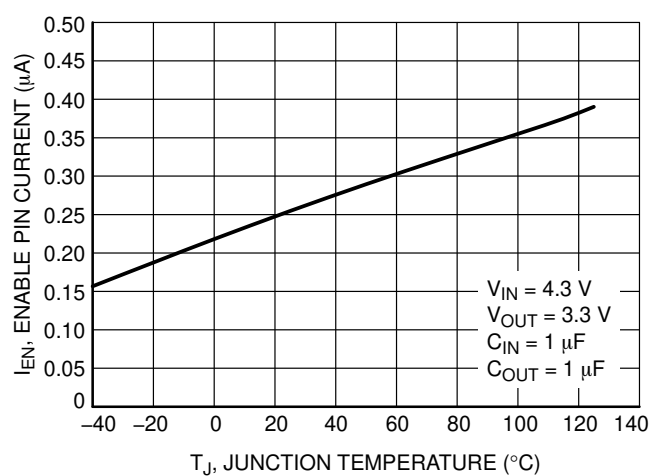

Figure 29. Enable Current Temperature

NCP160

TYPICAL CHARACTERISTICS

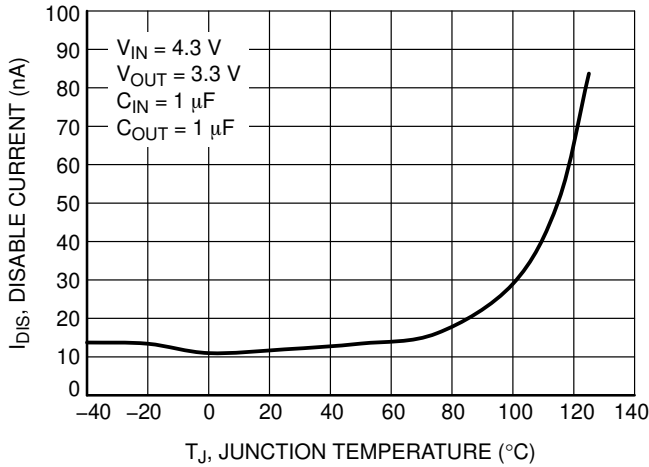

Figure 30. Disable Current vs. Temperature

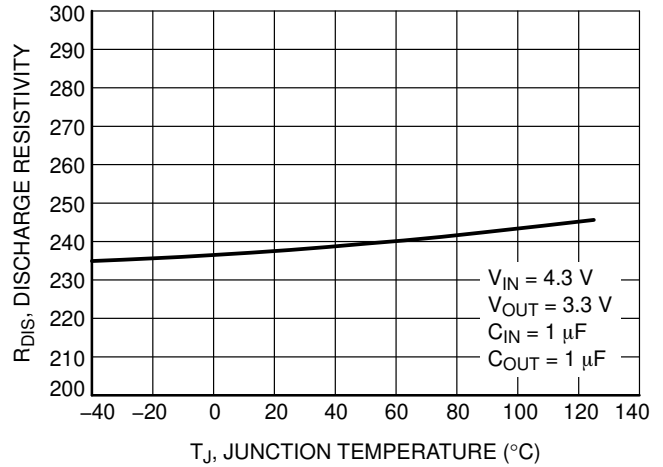

Figure 31. Discharge Resistivity vs. Temperature

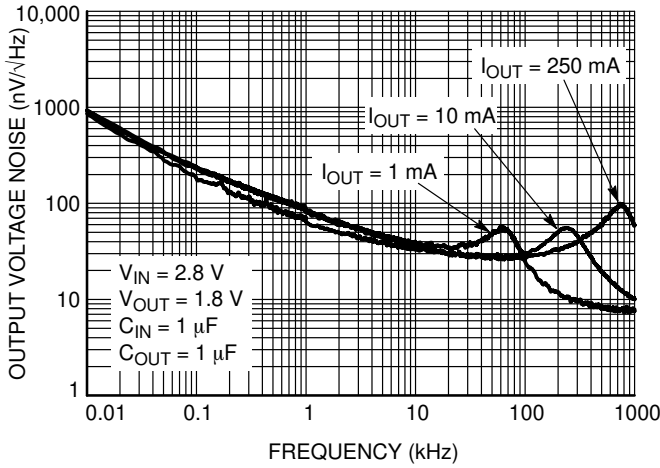

Figure 32. Output Voltage Noise Spectral Density – $V_{OUT} = 1.8\text{ V}$

I_{OUT}	RMS Output Noise (μV)	
	10 Hz – 100 kHz	100 Hz – 100 kHz
1 mA	14.62	14.10
10 mA	11.12	10.48
250 mA	10.37	9.82

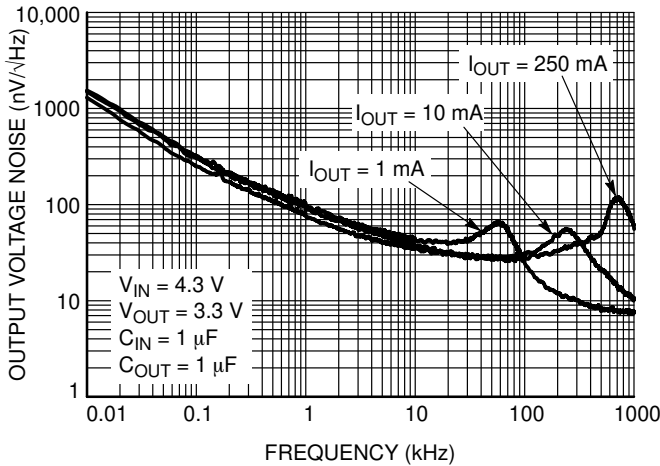

Figure 33. Output Voltage Noise Spectral Density – $V_{OUT} = 3.3\text{ V}$

I_{OUT}	RMS Output Noise (μV)	
	10 Hz – 100 kHz	100 Hz – 100 kHz
1 mA	16.9	15.79
10 mA	12.64	11.13
250 mA	11.96	10.64

TYPICAL CHARACTERISTICS

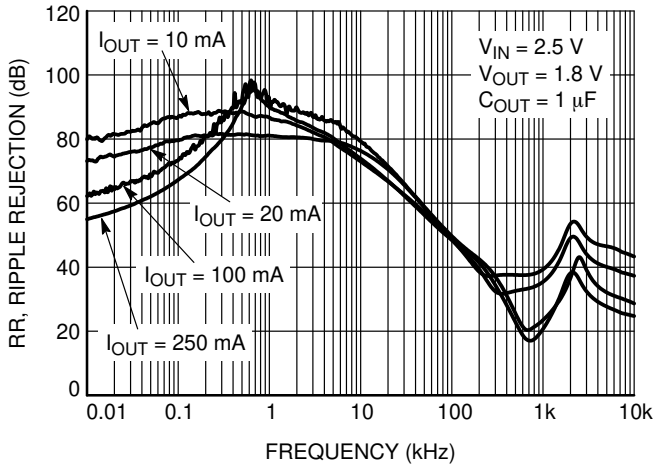

Figure 34. Power Supply Rejection Ratio, $V_{OUT} = 1.8\text{ V}$

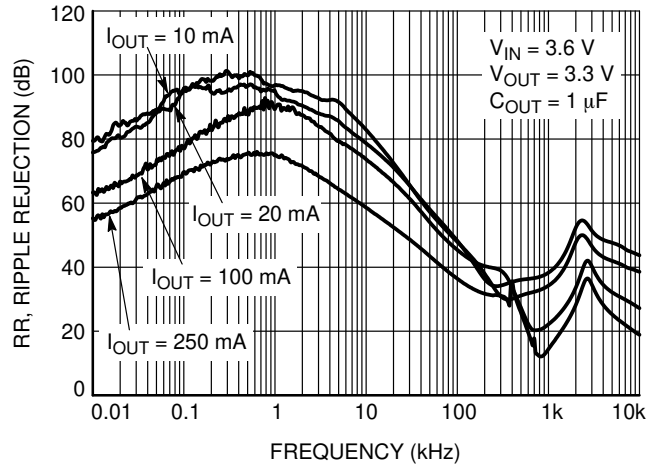

Figure 35. Power Supply Rejection Ratio, $V_{OUT} = 3.3\text{ V}$

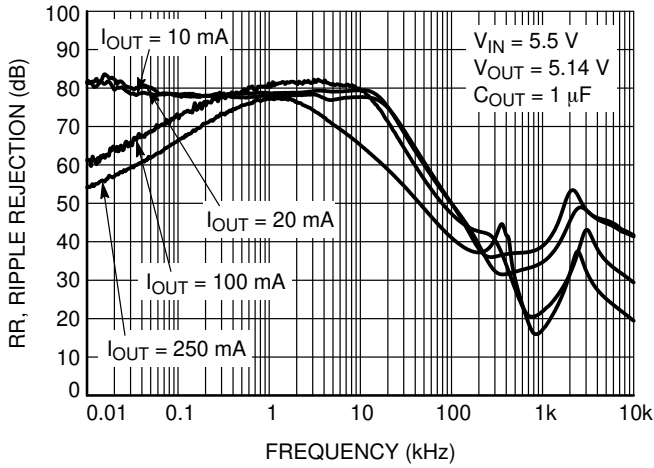

Figure 36. Power Supply Rejection Ratio, $V_{OUT} = 5.14\text{ V}$

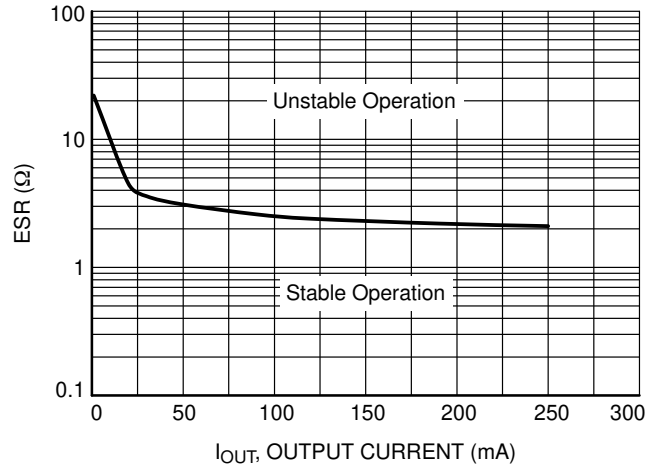

Figure 37. Stability vs. ESR

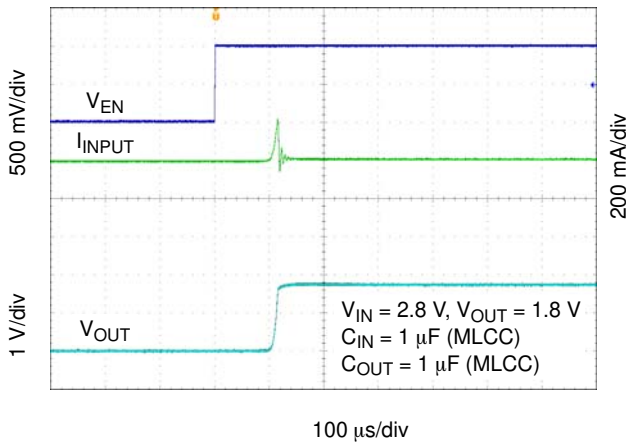

Figure 38. Enable Turn-on Response – $C_{OUT} = 1\text{ }\mu\text{F}$, $I_{OUT} = 10\text{ mA}$

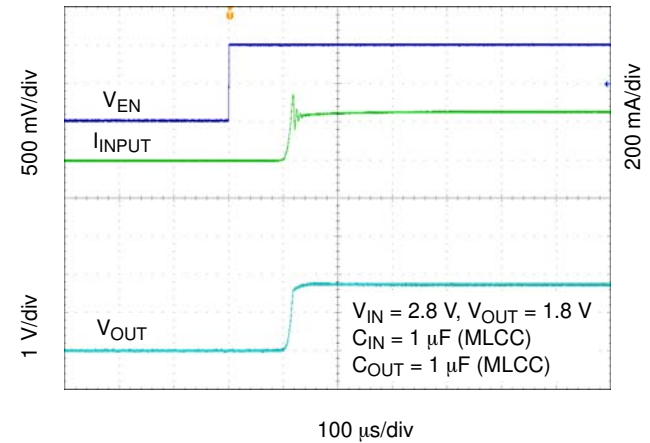

Figure 39. Enable Turn-on Response – $C_{OUT} = 1\text{ }\mu\text{F}$, $I_{OUT} = 250\text{ mA}$

TYPICAL CHARACTERISTICS

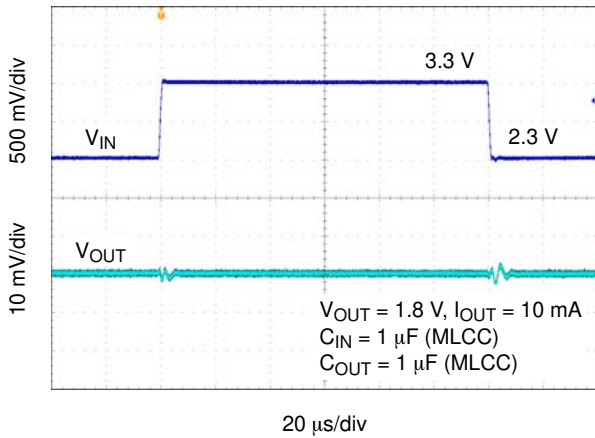

Figure 40. Line Transient Response – $V_{OUT} = 1.8\text{ V}$

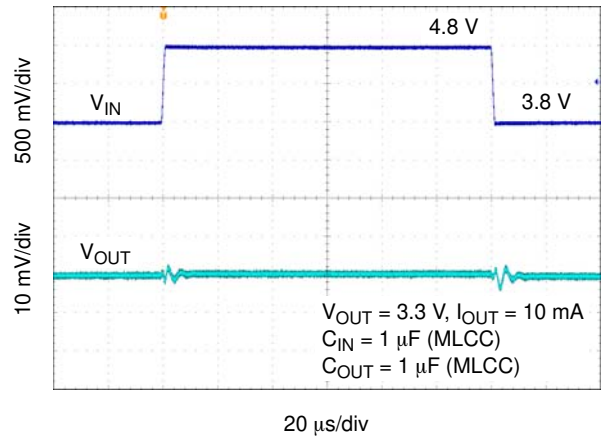

Figure 41. Line Transient Response – $V_{OUT} = 3.3\text{ V}$

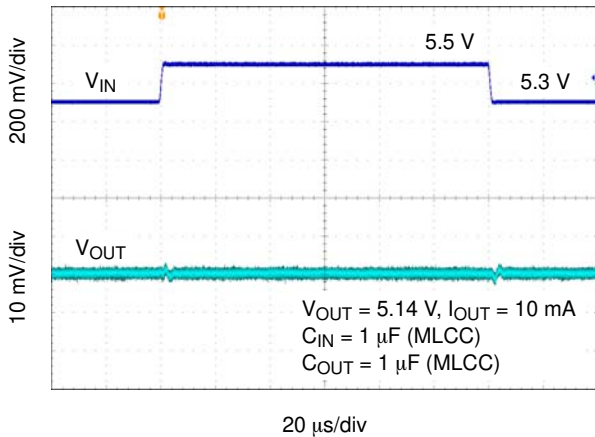

Figure 42. Line Transient Response – $V_{OUT} = 5.14\text{ V}$

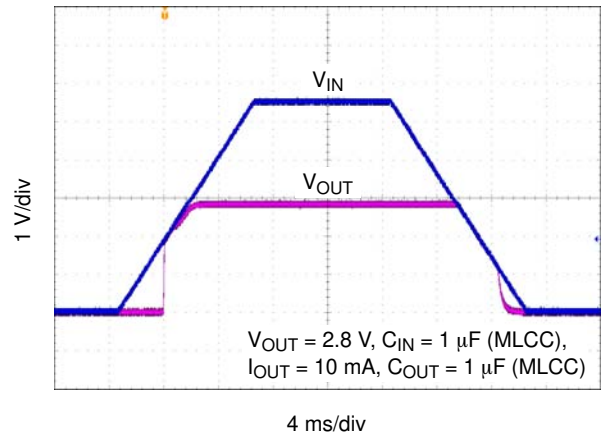

Figure 43. Turn-on/off – Slow Rising V_{IN}

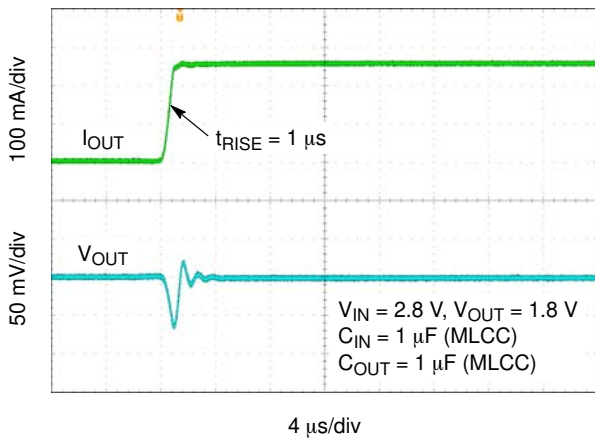

Figure 44. Load Transient Response – 1 mA to 250 mA – $V_{OUT} = 1.8\text{ V}$

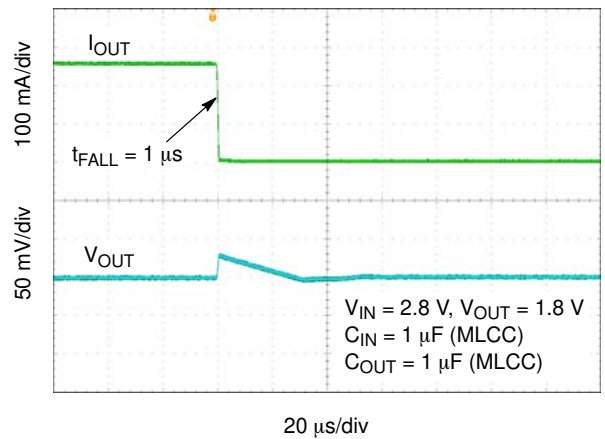

Figure 45. Load Transient Response – 250 mA to 1 mA – $V_{OUT} = 1.8\text{ V}$

NCP160

TYPICAL CHARACTERISTICS

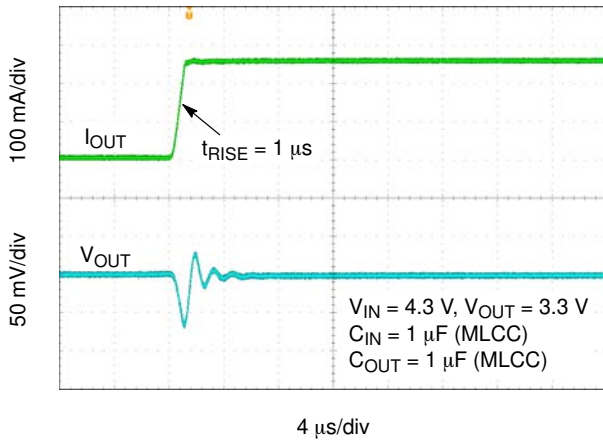

Figure 46. Load Transient Response – 1 mA to 250 mA – $V_{OUT} = 3.3$ V

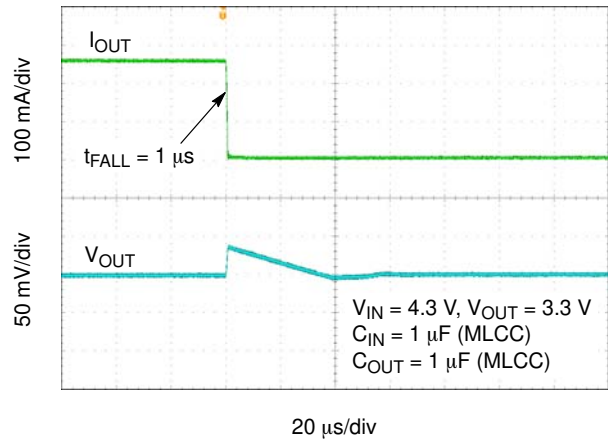

Figure 47. Load Transient Response – 250 mA to 1 mA – $V_{OUT} = 3.3$ V

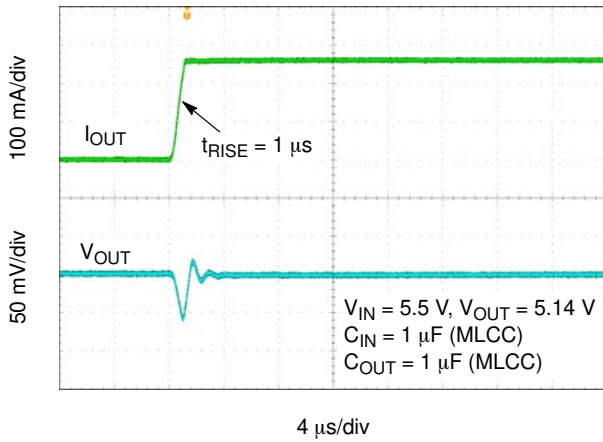

Figure 48. Load Transient Response – 1 mA to 250 mA – $V_{OUT} = 5.14$ V

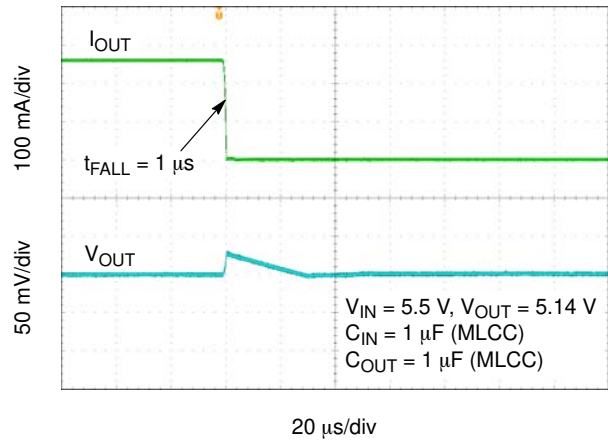

Figure 49. Load Transient Response – 250 mA to 1 mA – $V_{OUT} = 5.14$ V

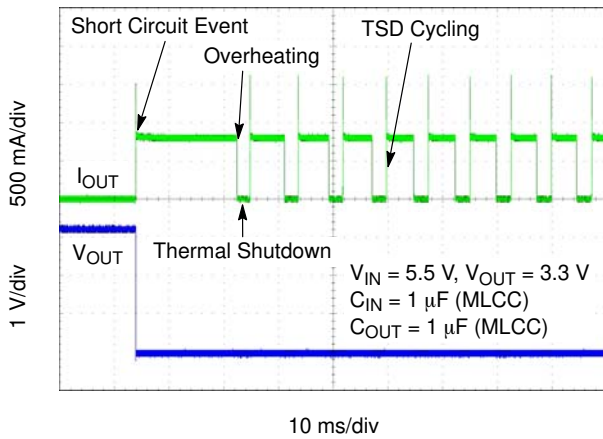

Figure 50. Short Circuit and Thermal Shutdown

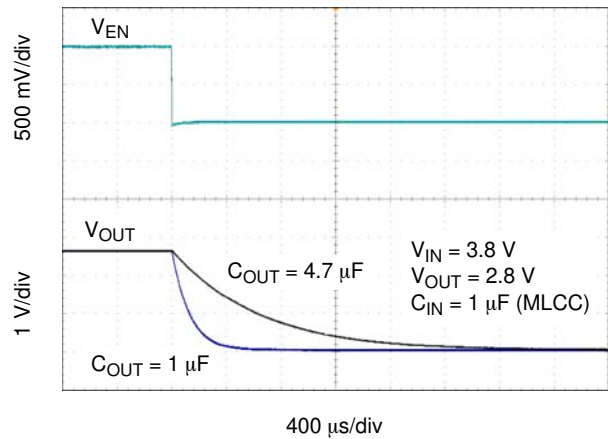

Figure 51. Enable Turn-off

APPLICATIONS INFORMATION

General

The NCP160 is an ultra–low noise 250 mA low dropout regulator designed to meet the requirements of RF applications and high performance analog circuits. The NCP160 device provides very high PSRR and excellent dynamic response. In connection with low quiescent current this device is well suitable for battery powered application such as cell phones, tablets and other. The NCP160 is fully protected in case of current overload, output short circuit and overheating.

Input Capacitor Selection (C_{IN})

Input capacitor connected as close as possible is necessary for ensure device stability. The X7R or X5R capacitor should be used for reliable performance over temperature range. The value of the input capacitor should be 1 μ F or greater to ensure the best dynamic performance. This capacitor will provide a low impedance path for unwanted AC signals or noise modulated onto constant input voltage. There is no requirement for the ESR of the input capacitor but it is recommended to use ceramic capacitors for their low ESR and ESL. A good input capacitor will limit the influence of input trace inductance and source resistance during sudden load current changes.

Output Decoupling (C_{OUT})

The NCP160 requires an output capacitor connected as close as possible to the output pin of the regulator. The recommended capacitor value is 1 μ F and X7R or X5R dielectric due to its low capacitance variations over the specified temperature range. The NCP160 is designed to remain stable with minimum effective capacitance of 0.7 μ F to account for changes with temperature, DC bias and package size. Especially for small package size capacitors such as 0201 the effective capacitance drops rapidly with the applied DC bias. Please refer Figure 52.



Figure 52. Capacity vs DC Bias Voltage

There is no requirement for the minimum value of Equivalent Series Resistance (ESR) for the C_{OUT} but the maximum value of ESR should be less than 2 Ω . Larger output capacitors and lower ESR could improve the load

transient response or high frequency PSRR. It is not recommended to use tantalum capacitors on the output due to their large ESR. The equivalent series resistance of tantalum capacitors is also strongly dependent on the temperature, increasing at low temperature.

Enable Operation

The NCP160 uses the EN pin to enable/disable its device and to deactivate/activate the active discharge function.

If the EN pin voltage is <0.4 V the device is guaranteed to be disabled. The pass transistor is turned–off so that there is virtually no current flow between the IN and OUT. The active discharge transistor is active so that the output voltage V_{OUT} is pulled to GND through a 280 Ω resistor. In the disable state the device consumes as low as typ. 10 nA from the V_{IN} .

If the EN pin voltage >1.2 V the device is guaranteed to be enabled. The NCP160 regulates the output voltage and the active discharge transistor is turned–off.

The EN pin has internal pull–down current source with typ. value of 200 nA which assures that the device is turned–off when the EN pin is not connected. In the case where the EN function isn’t required the EN should be tied directly to IN.

Output Current Limit

Output Current is internally limited within the IC to a typical 700 mA. The NCP60 will source this amount of current measured with a voltage drops on the 90% of the nominal V_{OUT} . If the Output Voltage is directly shorted to ground ($V_{OUT} = 0$ V), the short circuit protection will limit the output current to 690 mA (typ). The current limit and short circuit protection will work properly over whole temperature range and also input voltage range. There is no limitation for the short circuit duration.

Thermal Shutdown

When the die temperature exceeds the Thermal Shutdown threshold ($T_{SD} - 160^{\circ}\text{C}$ typical), Thermal Shutdown event is detected and the device is disabled. The IC will remain in this state until the die temperature decreases below the Thermal Shutdown Reset threshold ($T_{SDU} - 140^{\circ}\text{C}$ typical). Once the IC temperature falls below the 140°C the LDO is enabled again. The thermal shutdown feature provides the protection from a catastrophic device failure due to accidental overheating. This protection is not intended to be used as a substitute for proper heat sinking.

Power Dissipation

As power dissipated in the NCP160 increases, it might become necessary to provide some thermal relief. The maximum power dissipation supported by the device is dependent upon board design and layout. Mounting pad configuration on the PCB, the board material, and the ambient temperature affect the rate of junction temperature rise for the part.

NCP160

The maximum power dissipation the NCP160 can handle is given by:

$$P_{D(MAX)} = \frac{[125^{\circ}\text{C} - T_A]}{\theta_{JA}} \quad (\text{eq. 1})$$

The power dissipated by the NCP160 for given application conditions can be calculated from the following equations:

$$P_D \approx V_{IN} \cdot I_{GND} + I_{OUT}(V_{IN} - V_{OUT}) \quad (\text{eq. 2})$$

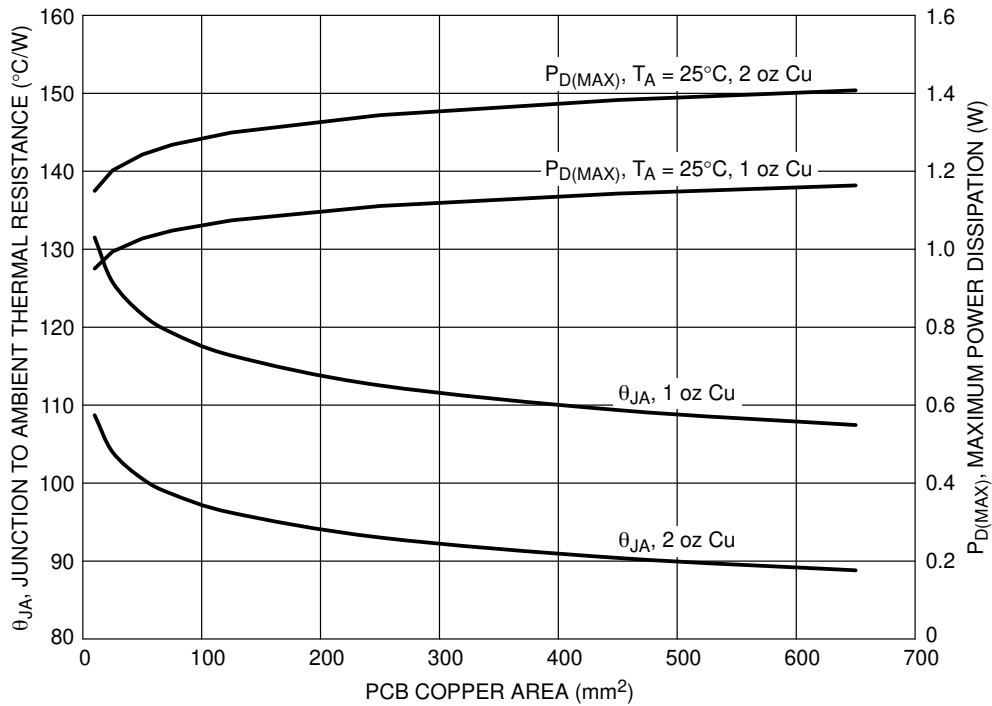

Figure 53. θ_{JA} and $P_{D(MAX)}$ vs. Copper Area (CSP4)

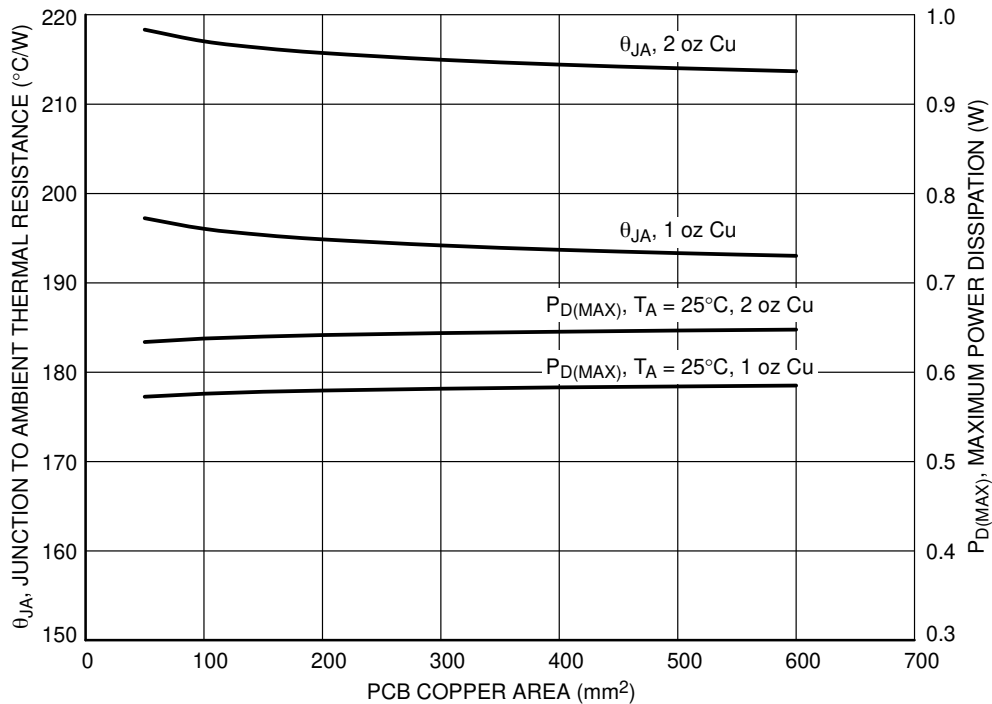

Figure 54. θ_{JA} and $P_{D(MAX)}$ vs. Copper Area (XDFN44)

NCP160

Reverse Current

The PMOS pass transistor has an inherent body diode which will be forward biased in the case that $V_{OUT} > V_{IN}$. Due to this fact in cases, where the extended reverse current condition can be anticipated the device may require additional external protection.

Power Supply Rejection Ratio

The NCP160 features very high Power Supply Rejection ratio. If desired the PSRR at higher frequencies in the range 100 kHz – 10 MHz can be tuned by the selection of C_{OUT} capacitor and proper PCB layout.

Turn-On Time

The turn-on time is defined as the time period from EN assertion to the point in which V_{OUT} will reach 98% of its nominal value. This time is dependent on various application conditions such as $V_{OUT(NOM)}$, C_{OUT} , T_A .

PCB Layout Recommendations

To obtain good transient performance and good regulation characteristics place C_{IN} and C_{OUT} capacitors close to the device pins and make the PCB traces wide. In order to minimize the solution size, use 0402 or 0201 capacitors with appropriate capacity. Larger copper area connected to the pins will also improve the device thermal resistance. The actual power dissipation can be calculated from the equation above (Equation 2). Expose pad can be tied to the GND pin for improvement power dissipation and lower device temperature.

NCP160

ORDERING INFORMATION

Device	Nominal Output Voltage	Description	Marking	Rotation	Package	Shipping†
NCP160AFCS180T2G	1.8 V	250 mA, Active Discharge	A	0°	WLCSP4 CASE 567KA (Pb-Free)	5000 / Tape & Reel
NCP160AFCS250T2G	2.5 V		D	0°		
NCP160AFCS270T2G	2.7 V		4	0°		
NCP160AFCS280T2G	2.8 V		E	0°		
NCP160AFCS285T2G	2.85 V		F	0°		
NCP160AFCS2925T2G	2.925 V		T	0°		
NCP160AFCS300T2G	3.0 V		J	0°		
NCP160AFCS320T2G	3.2 V		V	0°		
NCP160AFCS330T2G	3.3 V		K	0°		
NCP160AFCS350T2G	3.5 V		L	0°		
NCP160AFCS370T2G	3.7 V		Y	0°		
NCP160AFCS450T2G	4.5 V		P	0°		
NCP160AFCS500T2G	5.0 V		R	0°		
NCP160AFCS514T2G	5.14 V		Q	0°		
NCP160BFCS180T2G	1.8 V	250 mA, Non-Active Discharge	A	90°	WLCSP4 CASE 567KA (Pb-Free)	5000 / Tape & Reel
NCP160BFCS250T2G	2.5 V		D	90°		
NCP160BFCS280T2G	2.8 V		E	90°		
NCP160BFCS285T2G	2.85 V		F	90°		
NCP160BFCS2925T2G	2.925 V		T	90°		
NCP160BFCS300T2G	3.0 V		J	90°		
NCP160BFCS330T2G	3.3 V		K	90°		
NCP160BFCS350T2G	3.5 V		L	90°		
NCP160BFCS450T2G	4.5 V		P	90°		
NCP160BFCS500T2G	5.0 V		R	90°		
NCP160BFCS514T2G	5.14 V	Q	90°			
NCP160AFCT180T2G	1.8 V	250 mA, Active Discharge	A	0°	WLCSP4 CASE 567JZ (Pb-Free)	5000 / Tape & Reel
NCP160AFCT250T2G	2.5 V		D	0°		
NCP160AFCT270T2G	2.7 V		T	0°		
NCP160AFCT280T2G	2.8 V		E	0°		
NCP160AFCT285T2G	2.85 V		F	0°		
NCP160AFCT300T2G	3.0 V		J	0°		
NCP160AFCT330T2G	3.3 V		K	0°		
NCP160AFCTC330T2G	3.3 V	250 mA, Active Discharge, Backside Coating	K	0°		
NCP160AFCT350T2G	3.5 V	250 mA, Active Discharge	L	0°		
NCP160AFCT450T2G	4.5 V		P	0°		
NCP160AFCT500T2G	5.0 V		R	0°		
NCP160AFCT514T2G	5.14 V		Q	0°		
NCP160AFCTC180T2G	1.8 V	250 mA, Active Discharge, Backside Coating	A	0°		
NCP160BFCT180T2G	1.8 V	250 mA, Non-Active Discharge	A	90°		
NCP160BFCT210T2G	2.1 V		T	90°		
NCP160BFCT250T2G	2.5 V		D	90°		
NCP160BFCT280T2G	2.8 V		E	90°		
NCP160BFCT285T2G	2.85 V		F	90°		
NCP160BFCT300T2G	3.0 V		J	90°		
NCP160BFCT330T2G	3.3 V		K	90°		
NCP160BFCT350T2G	3.5 V		L	90°		
NCP160BFCT450T2G	4.5 V		P	90°		
NCP160BFCT500T2G	5.0 V		R	90°		
NCP160BFCT514T2G	5.14 V		Q	90°		

NCP160

ORDERING INFORMATION

Device	Nominal Output Voltage	Description	Marking	Package	Shipping
NCP160AMX180TBG	1.8 V	250 mA, Active Discharge	DF	XDFN4 (Pb-Free)	3000 / Tape & Reel
NCP160AMX1825TBG	1.825 V		D7		
NCP160AMX250TBG	2.5 V		DG		
NCP160AMX270TBG	2.7 V		D6		
NCP160AMX275TBG	2.75 V		D2		
NCP160AMX280TBG	2.8 V		DH		
NCP160AMX285TBG	2.85 V		DJ		
NCP160AMX290TBG	2.9 V		D4		
NCP160AMX300TBG	3.0 V		DK		
NCP160AMX320TBG	3.2 V		DY		
NCP160AMX310TBG	3.1 V		D3		
NCP160AMX330TBG	3.3 V		DA		
NCP160AMX350TBG	3.5 V		DL		
NCP160AMX450TBG	4.5 V		DM		
NCP160AMX500TBG	5.0 V		DW		
NCP160AMX514TBG	5.14 V		DC		
NCP160BMX180TBG	1.8 V	250 mA, Non-Active Discharge	EF	XDFN4 (Pb-Free)	3000 / Tape & Reel
NCP160BMX1825TBG	1.825 V		E7		
NCP160BMX250TBG	2.5 V		EG		
NCP160BMX275TBG	2.75 V		E2		
NCP160BMX280TBG	2.8 V		EH		
NCP160BMX285TBG	2.85 V		EJ		
NCP160BMX300TBG	3.0 V		EK		
NCP160BMX330TBG	3.3 V		EA		
NCP160BMX350TBG	3.5 V		EL		
NCP160BMX450TBG	4.5 V		EM		
NCP160BMX500TBG	5.0 V		EW		
NCP160BMX514TBG	5.14 V		EC		

†For information on tape and reel specifications, including part orientation and tape sizes, please refer to our Tape and Reel Packaging Specifications Brochure, BRD8011/D.

NCP160

PACKAGE DIMENSIONS

WLCSP4, 0.64x0.64
CASE 567JZ
ISSUE A

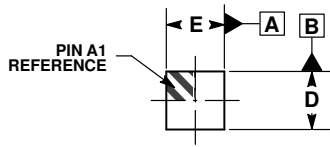

TOP VIEW

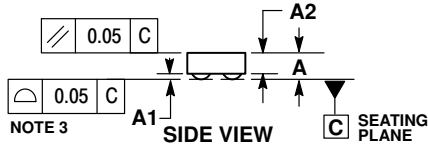

SIDE VIEW

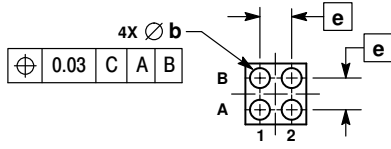

BOTTOM VIEW

NOTES:

1. DIMENSIONING AND TOLERANCING PER ASME Y14.5M, 1994.
2. CONTROLLING DIMENSION: MILLIMETERS.
3. COPLANARITY APPLIES TO SPHERICAL CROWNS OF SOLDER BALLS.

DIM	MILLIMETERS		
	MIN	NOM	MAX
A	---	---	0.33
A1	0.04	0.06	0.08
A2	0.23 REF		
b	0.195	0.210	0.225
D	0.610	0.640	0.670
E	0.610	0.640	0.670
e	0.35 BSC		

RECOMMENDED SOLDERING FOOTPRINT*

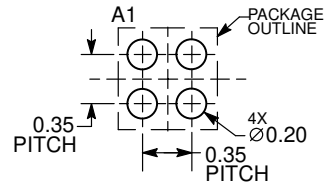

DIMENSIONS: MILLIMETERS

*For additional information on our Pb-Free strategy and soldering details, please download the ON Semiconductor Soldering and Mounting Techniques Reference Manual, SOLDERRM/D.

NCP160

PACKAGE DIMENSIONS

WLCSP4, 0.64x0.64
CASE 567KA
ISSUE A

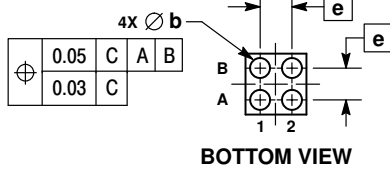
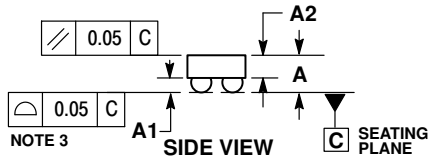
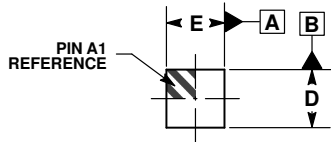

NOTES:

1. DIMENSIONING AND TOLERANCING PER ASME Y14.5M, 1994.
2. CONTROLLING DIMENSION: MILLIMETERS.
3. COPLANARITY APPLIES TO SPHERICAL CROWNS OF SOLDER BALLS.

DIM	MILLIMETERS		
	MIN	NOM	MAX
A	0.35	0.40	0.45
A1	0.14	0.16	0.18
A2	0.25 REF		
b	0.185	0.200	0.215
D	0.610	0.640	0.670
E	0.610	0.640	0.670
e	0.35 BSC		

RECOMMENDED SOLDERING FOOTPRINT*

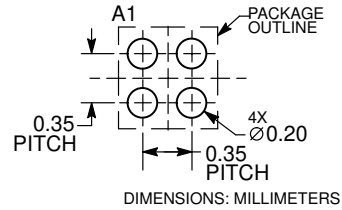

*For additional information on our Pb-Free strategy and soldering details, please download the ON Semiconductor Soldering and Mounting Techniques Reference Manual, SOLDERRM/D.

NCP160

PACKAGE DIMENSIONS

XDFN4 1.0x1.0, 0.65P
CASE 711AJ
ISSUE A

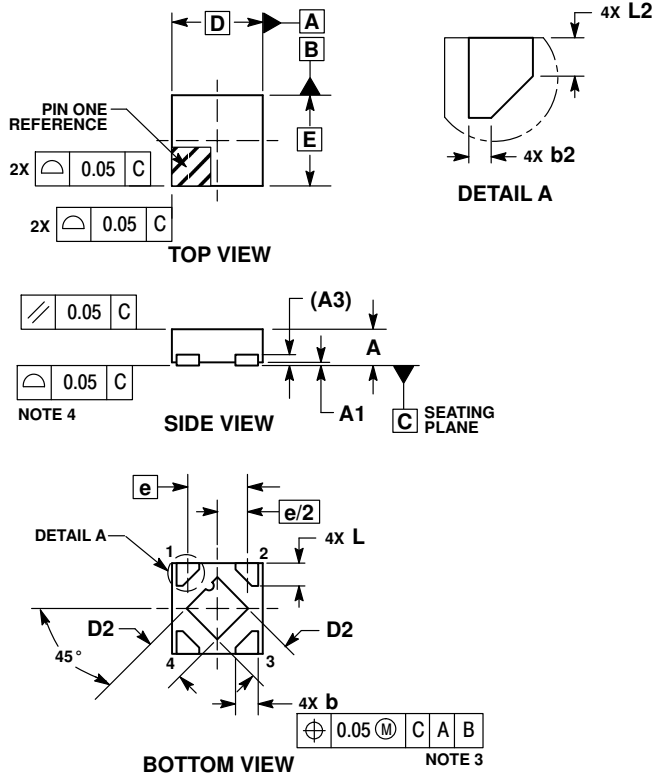

NOTES:

1. DIMENSIONING AND TOLERANCING PER ASME Y14.5M, 1994.
2. CONTROLLING DIMENSION: MILLIMETERS.
3. DIMENSION b APPLIES TO PLATED TERMINAL AND IS MEASURED BETWEEN 0.15 AND 0.20 mm FROM THE TERMINAL TIPS.
4. COPLANARITY APPLIES TO THE EXPOSED PAD AS WELL AS THE TERMINALS.

MILLIMETERS		
DIM	MIN	MAX
A	0.33	0.43
A1	0.00	0.05
A3	0.10	REF
b	0.15	0.25
b2	0.02	0.12
D	1.00	BSC
D2	0.43	0.53
E	1.00	BSC
e	0.65	BSC
L	0.20	0.30
L2	0.07	0.17

RECOMMENDED MOUNTING FOOTPRINT*

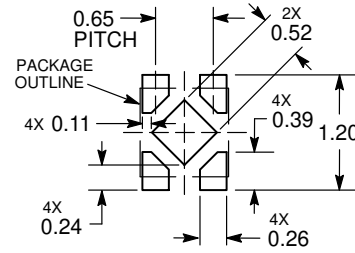

*For additional information on our Pb-Free strategy and soldering details, please download the ON Semiconductor Soldering and Mounting Techniques Reference Manual, SOLDERRM/D.

ON Semiconductor and are trademarks of Semiconductor Components Industries, LLC dba ON Semiconductor or its subsidiaries in the United States and/or other countries. ON Semiconductor owns the rights to a number of patents, trademarks, copyrights, trade secrets, and other intellectual property. A listing of ON Semiconductor's product/patent coverage may be accessed at www.onsemi.com/site/pdf/Patent-Marking.pdf. ON Semiconductor reserves the right to make changes without further notice to any products herein. ON Semiconductor makes no warranty, representation or guarantee regarding the suitability of its products for any particular purpose, nor does ON Semiconductor assume any liability arising out of the application or use of any product or circuit, and specifically disclaims any and all liability, including without limitation special, consequential or incidental damages. Buyer is responsible for its products and applications using ON Semiconductor products, including compliance with all laws, regulations and safety requirements or standards, regardless of any support or applications information provided by ON Semiconductor. "Typical" parameters which may be provided in ON Semiconductor data sheets and/or specifications can and do vary in different applications and actual performance may vary over time. All operating parameters, including "Typicals" must be validated for each customer application by customer's technical experts. ON Semiconductor does not convey any license under its patent rights nor the rights of others. ON Semiconductor products are not designed, intended, or authorized for use as a critical component in life support systems or any FDA Class 3 medical devices or medical devices with a same or similar classification in a foreign jurisdiction or any devices intended for implantation in the human body. Should Buyer purchase or use ON Semiconductor products for any such unintended or unauthorized application, Buyer shall indemnify and hold ON Semiconductor and its officers, employees, subsidiaries, affiliates, and distributors harmless against all claims, costs, damages, and expenses, and reasonable attorney fees arising out of, directly or indirectly, any claim of personal injury or death associated with such unintended or unauthorized use, even if such claim alleges that ON Semiconductor was negligent regarding the design or manufacture of the part. ON Semiconductor is an Equal Opportunity/Affirmative Action Employer. This literature is subject to all applicable copyright laws and is not for resale in any manner.

PUBLICATION ORDERING INFORMATION

LITERATURE FULFILLMENT:
Literature Distribution Center for ON Semiconductor
19521 E. 32nd Pkwy, Aurora, Colorado 80011 USA
Phone: 303-675-2175 or 800-344-3860 Toll Free USA/Canada
Fax: 303-675-2176 or 800-344-3867 Toll Free USA/Canada
Email: orderlit@onsemi.com

N. American Technical Support: 800-282-9855 Toll Free USA/Canada
Europe, Middle East and Africa Technical Support:
Phone: 421 33 790 2910
Japan Customer Focus Center
Phone: 81-3-5817-1050

ON Semiconductor Website: www.onsemi.com
Order Literature: <http://www.onsemi.com/orderlit>
For additional information, please contact your local Sales Representative