



Chipsmall Limited consists of a professional team with an average of over 10 year of expertise in the distribution of electronic components. Based in Hongkong, we have already established firm and mutual-benefit business relationships with customers from,Europe,America and south Asia,supplying obsolete and hard-to-find components to meet their specific needs.

With the principle of “Quality Parts,Customers Priority,Honest Operation,and Considerate Service”,our business mainly focus on the distribution of electronic components. Line cards we deal with include Microchip,ALPS,ROHM,Xilinx,Pulse,ON,Everlight and Freescale. Main products comprise IC,Modules,Potentiometer,IC Socket,Relay,Connector.Our parts cover such applications as commercial,industrial, and automotives areas.

We are looking forward to setting up business relationship with you and hope to provide you with the best service and solution. Let us make a better world for our industry!



Contact us

Tel: +86-755-8981 8866 Fax: +86-755-8427 6832

Email & Skype: info@chipsmall.com Web: www.chipsmall.com

Address: A1208, Overseas Decoration Building, #122 Zhenhua RD., Futian, Shenzhen, China



NCP186

Fast Transient Response Low Voltage 1 A LDO

The NCP186x series are CMOS LDO regulators featuring 1 A output current. The input voltage is as low as 1.8 V and the output voltage can be set from 1.2 V.

Features

- Operating Input Voltage Range: 1.8 V to 5.5 V
- Output Voltage Range: 1.2 to 3.9 V
- Quiescent Current typ. 90 μ A
- Low Dropout: 100 mV typ. at 1 A, $V_{OUT} = 3.0$ V
- High Output Voltage Accuracy $\pm 1\%$
- Stable with Small 1 μ F Ceramic Capacitors
- Over-current Protection
- Built-in Soft Start Circuit to Suppress Inrush Current
- Thermal Shutdown Protection: 165°C
- With (NCP186A) and Without (NCP186B) Output Discharge Function
- Available in Small xDFN8 1.2 x 1.6 mm Package
- These are Pb-free Devices

Typical Applications

- Battery Powered Equipment
- Portable Communication Equipment
- Cameras, Image Sensors and Camcorders

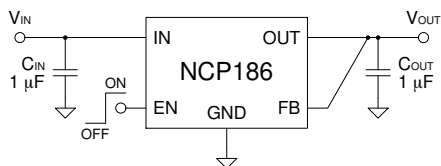

Figure 1. Typical Application Schematic



ON Semiconductor®

www.onsemi.com



XDFN8
MX SUFFIX
CASE 711AS

PIN CONNECTIONS

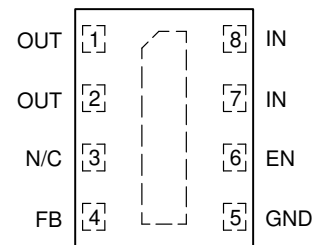

(Top View)

MARKING DIAGRAM

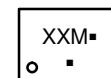

XX = Specific Device Code
M = Date Code
• = Pb-Free Package

(Note: Microdot may be in either location)

ORDERING INFORMATION

See detailed ordering and shipping information in the ordering information section on page 4 of this data sheet.

NCP186

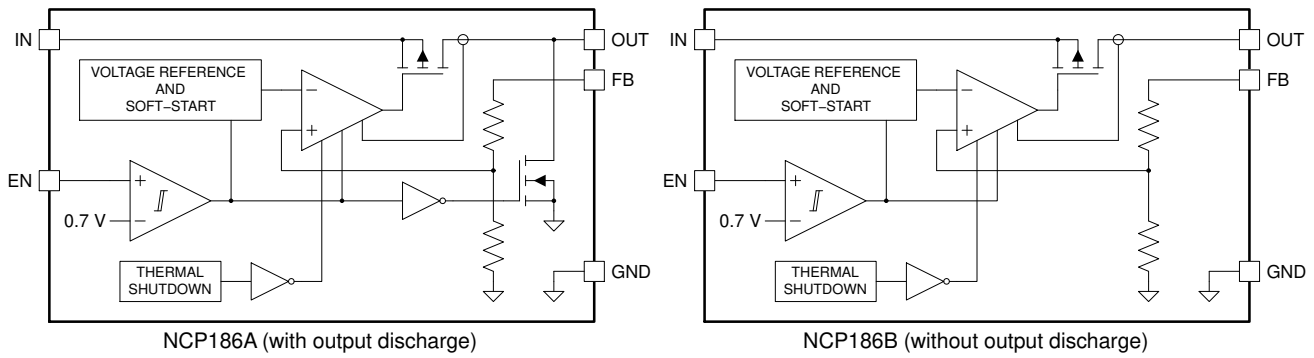

Figure 2. Internal Block Diagram

Table 1. PIN FUNCTION DESCRIPTION

Pin No. XDFN6	Pin Name	Description
1	OUT	LDO output pin
2		
3	N/C	Not internally connected. This pin can be tied to the ground plane to improve thermal dissipation.
4	FB	Feedback input pin
5	GND	Ground pin
6	EN	Chip enable input pin (active "H")
7	IN	Power supply input pin
8		
EPAD	EPAD	It's recommended to connect the EPAD to GND, but leaving it open is also acceptable

Table 2. ABSOLUTE MAXIMUM RATINGS

Rating	Symbol	Value	Unit
Input Voltage (Note 1)	IN	-0.3 to 6.0	V
Output Voltage	OUT	-0.3 to $V_{IN} + 0.3$	V
Chip Enable Input	EN	-0.3 to 6.0	V
Output Current	I_{OUT}	Internally Limited	mA
Maximum Junction Temperature	$T_{J(MAX)}$	150	°C
Storage Temperature	T_{STG}	-55 to 150	°C
ESD Capability, Human Body Model (Note 2)	ESD _{HBM}	2000	V
ESD Capability, Machine Model (Note 2)	ESD _{MM}	200	V

Stresses exceeding those listed in the Maximum Ratings table may damage the device. If any of these limits are exceeded, device functionality should not be assumed, damage may occur and reliability may be affected.

1. Refer to ELECTRICAL CHARACTERISTICS and APPLICATION INFORMATION for Safe Operating Area.

2. This device series incorporates ESD protection and is tested by the following methods:

ESD Human Body Model tested per AEC-Q100-002 (EIA/JESD22-A114)

ESD Machine Model tested per AEC-Q100-003 (EIA/JESD22-A115)

Latchup Current Maximum Rating tested per JEDEC standard: JESD78

Table 3. THERMAL CHARACTERISTICS

Rating	Symbol	Value	Unit
Thermal Resistance, Junction-to-Air, XDFN8 1.2 mm x 1.6 mm	$R_{\theta JA}$	111	°C/W

NCP186

Table 4. ELECTRICAL CHARACTERISTICS

$V_{IN} = V_{OUT_NOM} + 0.5\text{ V}$ or $V_{IN} = 1.8\text{ V}$ whichever is greater; $I_{OUT} = 1\text{ mA}$; $C_{IN} = C_{OUT} = 1.0\text{ }\mu\text{F}$ (effective capacitance) (Note 3); $V_{EN} = 1.2\text{ V}$; $T_J = 25^\circ\text{C}$; unless otherwise noted. The specifications in bold are guaranteed at $-40^\circ\text{C} \leq T_J \leq 125^\circ\text{C}$.

Parameter	Test Conditions	Symbol	Min	Typ	Max	Unit	
Operating Input Voltage		V_{IN}	1.8		5.5	V	
Output Voltage	$V_{OUT_NOM} + 0.5\text{ V} \leq V_{IN} \leq 5.5\text{ V}$, $I_{OUT} = 0\text{ to }1\text{ A}$, $-40^\circ\text{C} \leq T_J \leq 85^\circ\text{C}$	V_{OUT}	-1.0		1.0	%	
	$V_{OUT_NOM} + 0.5\text{ V} \leq V_{IN} \leq 5.5\text{ V}$, $I_{OUT} = 0\text{ to }1\text{ A}$, $-40^\circ\text{C} \leq T_J \leq 125^\circ\text{C}$		-2.0		1.0		
Load Regulation	$I_{OUT} = 1\text{ mA to }1000\text{ mA}$	LoadReg		0.7	5.0	mV	
Line Regulation	$V_{IN} = V_{OUT_NOM} + 0.5\text{ V to }5.0\text{ V}$	LineReg		0.002	0.1	%/V	
Dropout Voltage	$I_{OUT} = 1\text{ A}$ When V_{OUT} falls to $V_{OUT_NOM} - 100\text{ mV}$	V_{DO}		405	585	mV	
			$V_{OUT_NOM} = 1.2\text{ V}$		180		295
			$V_{OUT_NOM} = 1.75\text{ V}$		175		285
			$V_{OUT_NOM} = 1.8\text{ V}$		170		280
			$V_{OUT_NOM} = 1.85\text{ V}$		120		190
			$V_{OUT_NOM} = 2.5\text{ V}$		110		170
			$V_{OUT_NOM} = 2.8\text{ V}$		100		160
			$V_{OUT_NOM} = 3.0\text{ V}$		95		145
			$V_{OUT_NOM} = 3.3\text{ V}$		92		135
	$V_{OUT_NOM} = 3.5\text{ V}$		86	130			
Quiescent Current	$I_{OUT} = 0\text{ mA}$	I_Q		90	140	μA	
Standby Current	$V_{EN} = 0\text{ V}$	I_{STBY}		0.1	1.5	μA	
Output Current Limit	$V_{OUT} = 90\%$ of V_{OUT_NOM}	I_{OCL}	1100	1400		mA	
Output Short Circuit Current	$V_{OUT} = 0\text{ V}$	I_{OSC}	1100	1400		mA	
Enable Input Current		I_{EN}		0.15	0.6	μA	
Enable Threshold Voltage	EN Input Voltage "H"	V_{ENH}	1.0			V	
	EN Input Voltage "L"	V_{ENL}			0.4		
Power Supply Rejection Ratio	$V_{IN} = V_{OUT_NOM} + 1.0\text{ V}$, Ripple 0.2 Vp-p, $I_{OUT} = 30\text{ mA}$, $f = 1\text{ kHz}$	PSRR		75		dB	
Output Noise	$f = 10\text{ Hz to }100\text{ kHz}$	V_N		48		μV_{RMS}	
Output Discharge Resistance (NCP186A option only)	$V_{IN} = 5.5\text{ V}$, $V_{EN} = 0\text{ V}$, $V_{OUT} = 1.8\text{ V}$	R_{AD}		34		Ω	
Thermal Shutdown Temperature	Temperature rising from $T_J = +25^\circ\text{C}$	T_{SD}		165		$^\circ\text{C}$	
Thermal Shutdown Hysteresis	Temperature falling from T_{SD}	T_{SDH}		20		$^\circ\text{C}$	

Product parametric performance is indicated in the Electrical Characteristics for the listed test conditions, unless otherwise noted. Product performance may not be indicated by the Electrical Characteristics if operated under different conditions.

3. Effective capacitance, including the effect of DC bias, tolerance and temperature. See the Application Information section for more information.

NCP186

ORDERING INFORMATION TABLE

Part Number	Voltage Option	Marking	Option	Package	Shipping
NCP186AMX120TAG	1.2 V	FA	With active discharge	XDFN-8 (Pb-Free) 711AS	3000/Tape&Reel
NCP186AMX175TAG	1.75 V	FC	With active discharge		
NCP186AMX180TAG	1.8 V	FD	With active discharge		
NCP186AMX185TAG	1.85 V	FL	With active discharge		
NCP186AMX250TAG	2.5 V	FE	With active discharge		
NCP186AMX280TAG	2.8 V	FF	With active discharge		
NCP186AMX300TAG	3.0 V	FG	With active discharge		
NCP186AMX330TAG	3.3 V	FH	With active discharge		
NCP186AMX350TAG	3.5 V	FJ	With active discharge		
NCP186AMX390TAG	3.9 V	FK	With active discharge		
NCP186BMX120TAG	1.2 V	HA	Without active discharge	XDFN-8 (Pb-Free) 711AS	3000/Tape&Reel
NCP186BMX175TAG	1.75 V	HC	Without active discharge		
NCP186BMX180TAG	1.8 V	HD	Without active discharge		
NCP186BMX185TAG	1.85 V	HL	Without active discharge		
NCP186BMX250TAG	2.5 V	HE	Without active discharge		
NCP186BMX280TAG	2.8 V	HF	Without active discharge		
NCP186BMX300TAG	3.0 V	HG	Without active discharge		
NCP186BMX330TAG	3.3 V	HH	Without active discharge		
NCP186BMX350TAG	3.5 V	HJ	Without active discharge		
NCP186BMX390TAG	3.9 V	HK	Without active discharge		

NCP186

TYPICAL CHARACTERISTICS

$V_{IN} = V_{OUT-NOM} + 0.5 \text{ V}$ or $V_{IN} = 1.8 \text{ V}$, whichever is greater, $V_{EN} = 1.2 \text{ V}$, $I_{OUT} = 1 \text{ mA}$, $C_{IN} = C_{OUT} = 1.0 \mu\text{F}$, $T_J = 25^\circ\text{C}$.

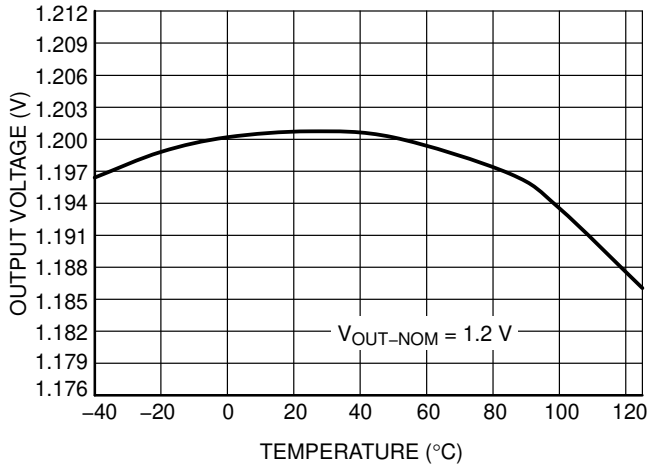

Figure 3. Output Voltage vs. Temperature

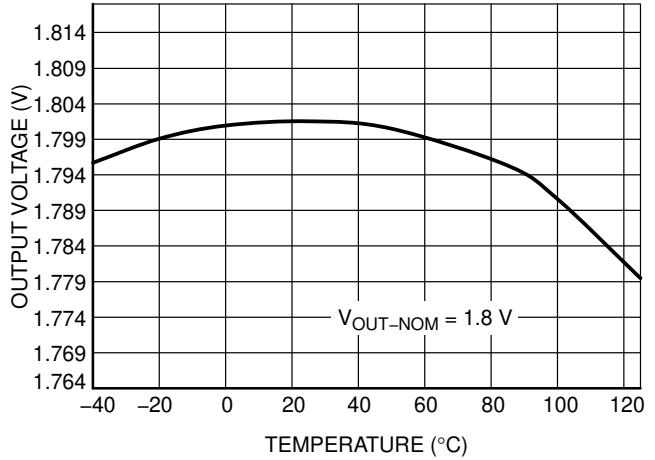

Figure 4. Output Voltage vs. Temperature

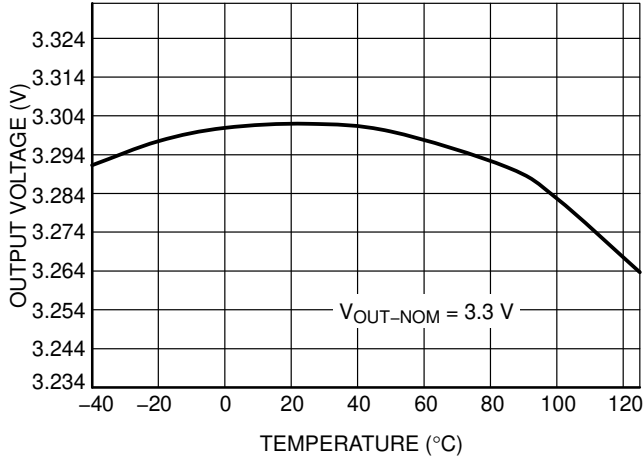

Figure 5. Output Voltage vs. Temperature

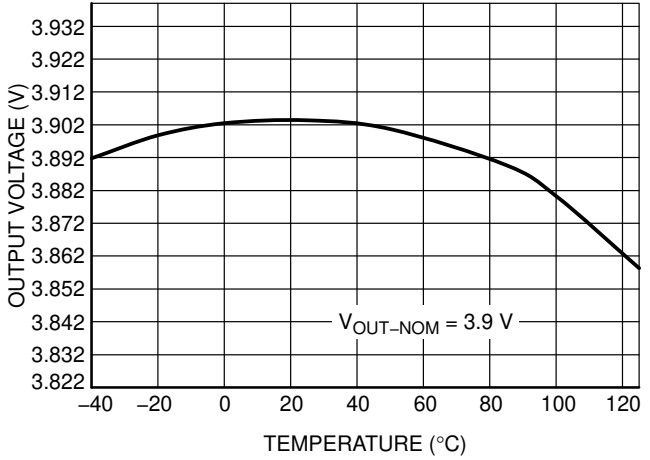

Figure 6. Output Voltage vs. Temperature

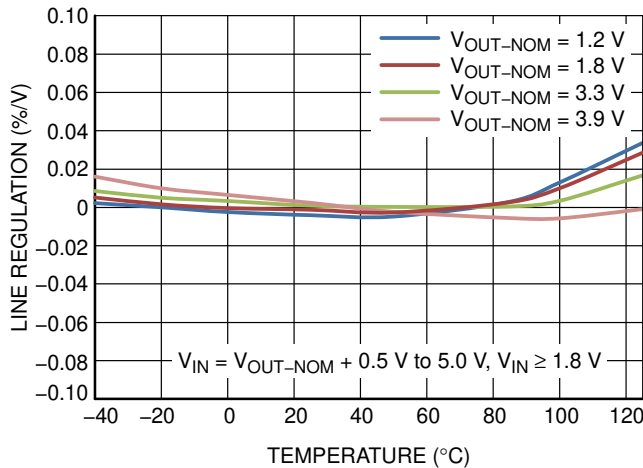

Figure 7. Line Regulation vs. Temperature

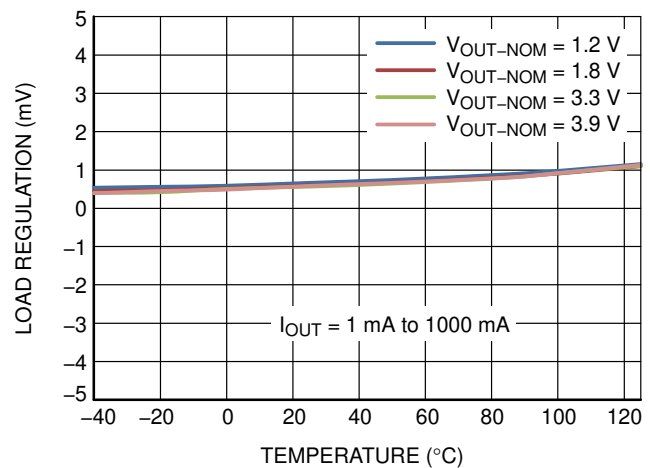

Figure 8. Load Regulation vs. Temperature

TYPICAL CHARACTERISTICS

$V_{IN} = V_{OUT-NOM} + 0.5\text{ V}$ or $V_{IN} = 1.8\text{ V}$, whichever is greater, $V_{EN} = 1.2\text{ V}$, $I_{OUT} = 1\text{ mA}$, $C_{IN} = C_{OUT} = 1.0\text{ }\mu\text{F}$, $T_J = 25^\circ\text{C}$.

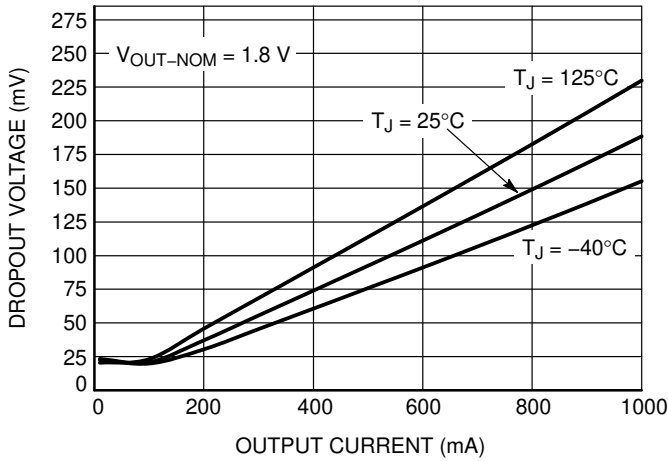

Figure 9. Dropout Voltage vs. Output Current

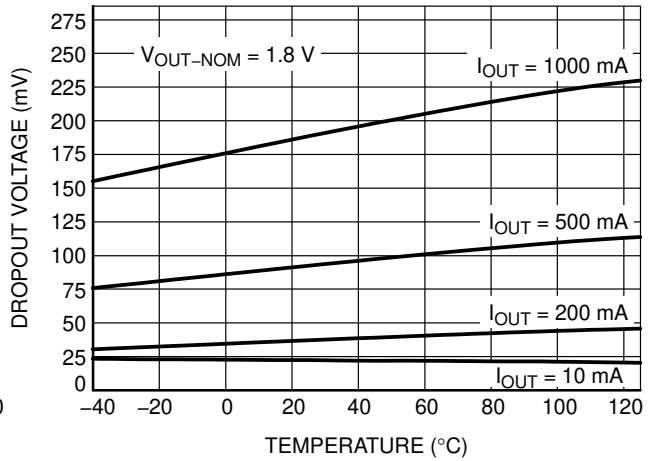

Figure 10. Dropout Voltage vs. Temperature

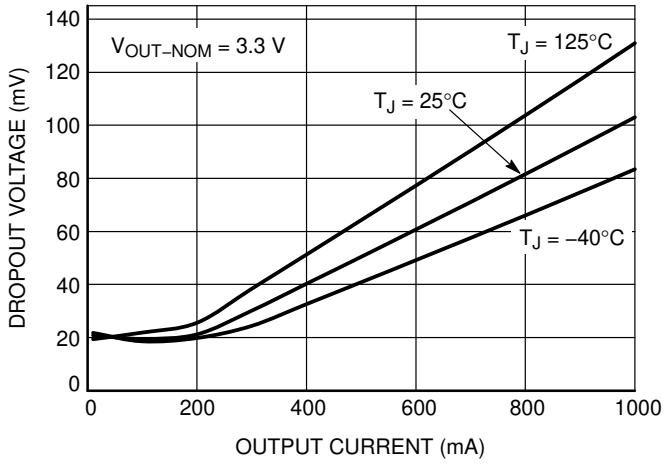

Figure 11. Dropout Voltage vs. Output Current

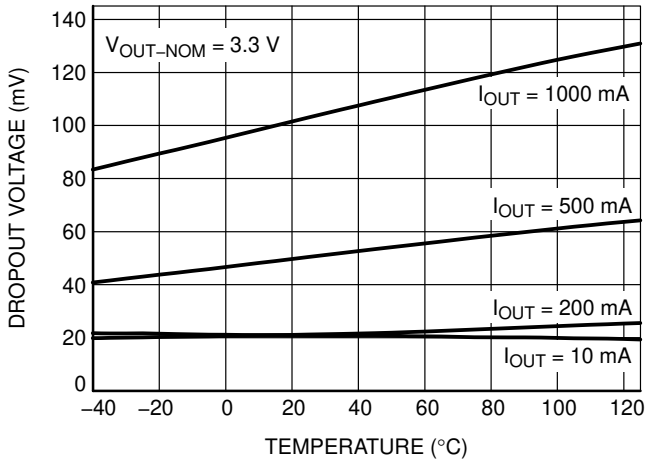

Figure 12. Dropout Voltage vs. Temperature

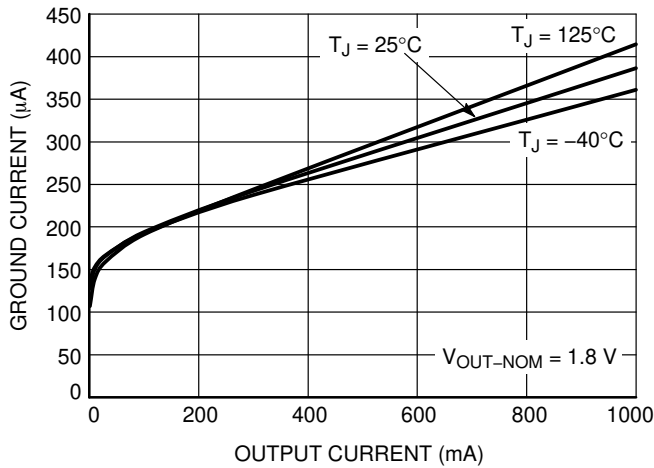

Figure 13. Ground Current vs. Output Current

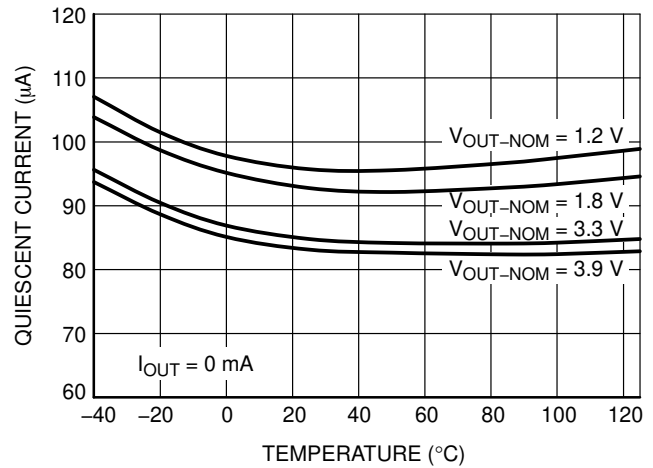

Figure 14. Quiescent Current vs. Temperature

TYPICAL CHARACTERISTICS

$V_{IN} = V_{OUT-NOM} + 0.5\text{ V}$ or $V_{IN} = 1.8\text{ V}$, whichever is greater, $V_{EN} = 1.2\text{ V}$, $I_{OUT} = 1\text{ mA}$, $C_{IN} = C_{OUT} = 1.0\text{ }\mu\text{F}$, $T_J = 25^\circ\text{C}$.

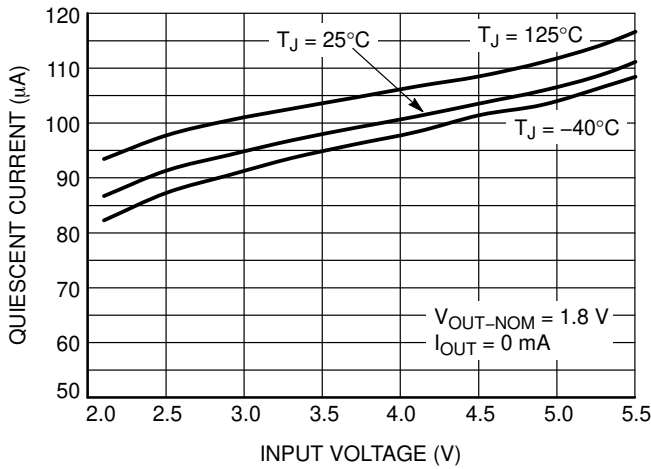

Figure 15. Quiescent Current vs. Input Voltage

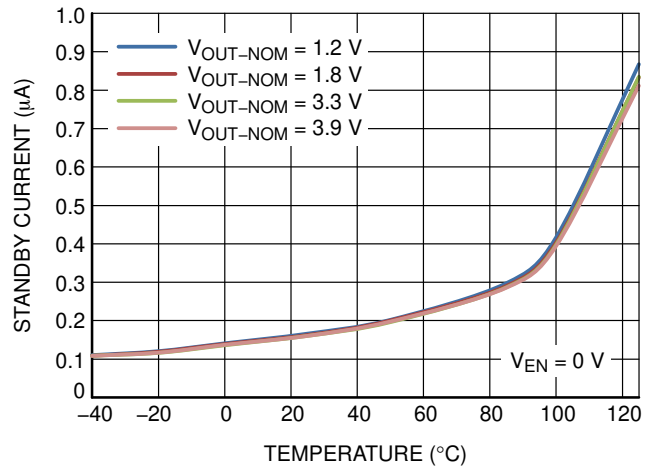

Figure 16. Standby Current vs. Temperature

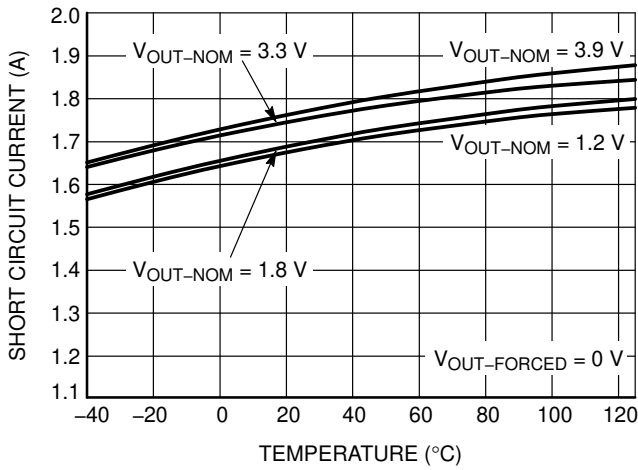

Figure 17. Short Circuit Current vs. Temperature

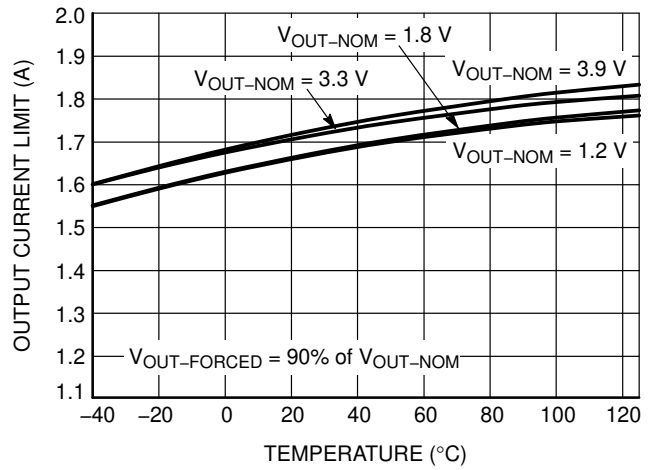

Figure 18. Output Current Limit vs. Temperature

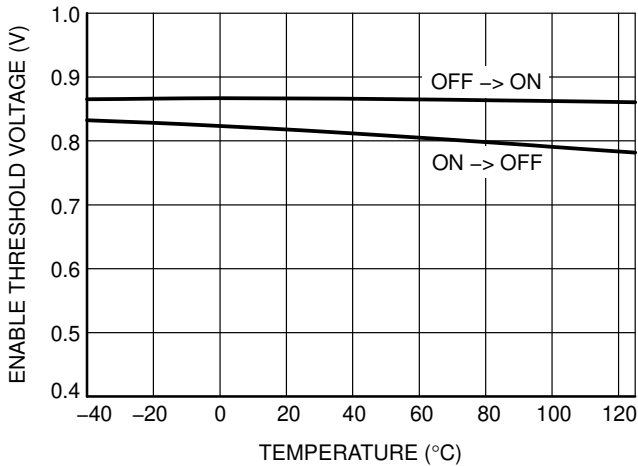

Figure 19. Enable Threshold Voltage vs. Temperature

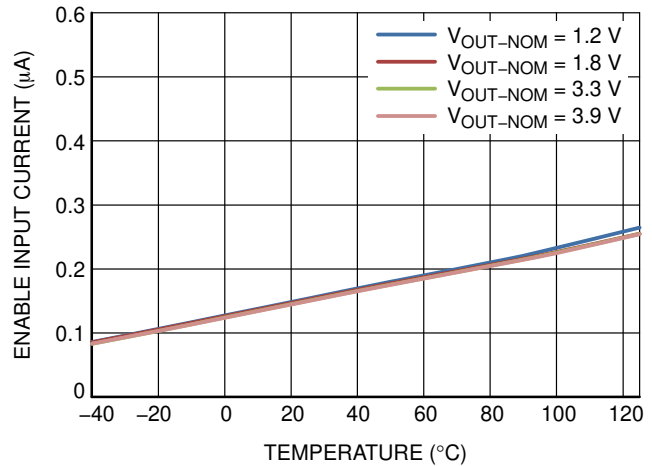

Figure 20. Enable Input Current vs. Temperature

NCP186

TYPICAL CHARACTERISTICS

$V_{IN} = V_{OUT-NOM} + 0.5 \text{ V}$ or $V_{IN} = 1.8 \text{ V}$, whichever is greater, $V_{EN} = 1.2 \text{ V}$, $I_{OUT} = 1 \text{ mA}$, $C_{IN} = C_{OUT} = 1.0 \mu\text{F}$, $T_J = 25^\circ\text{C}$.

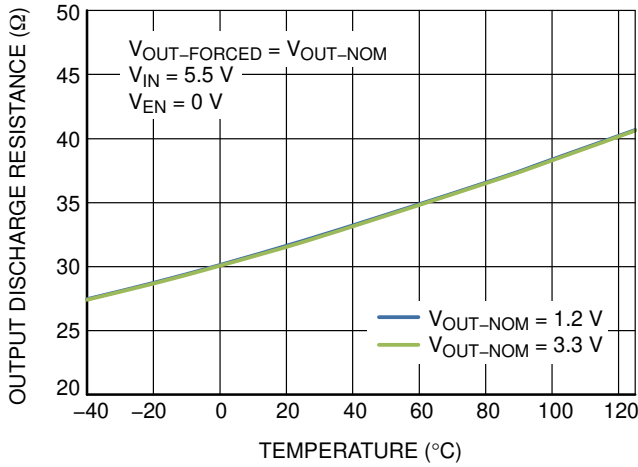

Figure 21. Output Discharge Resistance vs. Temperature (NCP186A option only)

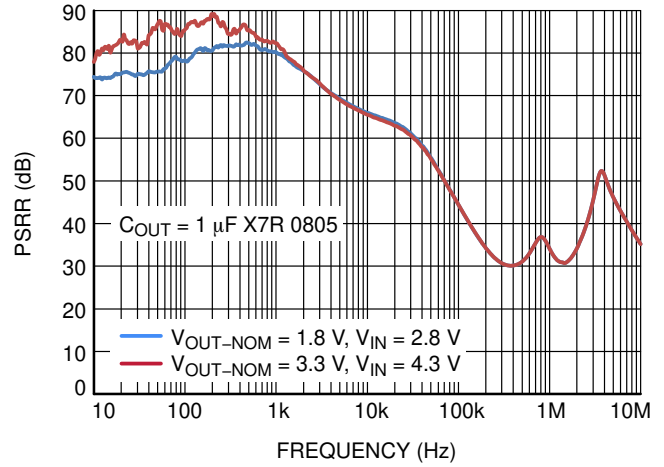

Figure 22. Power Supply Rejection Ratio

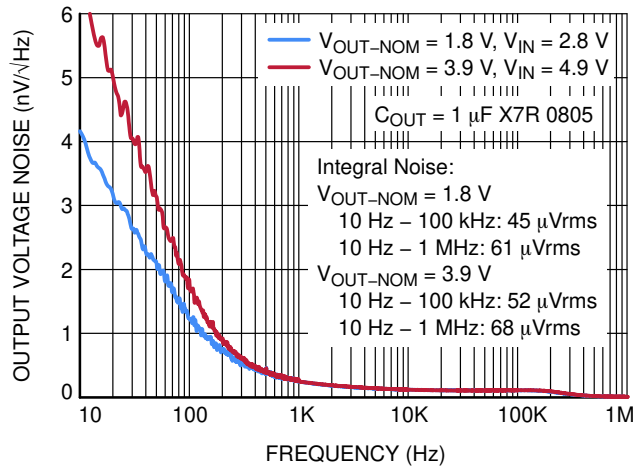

Figure 23. Output Voltage Noise Spectral Density

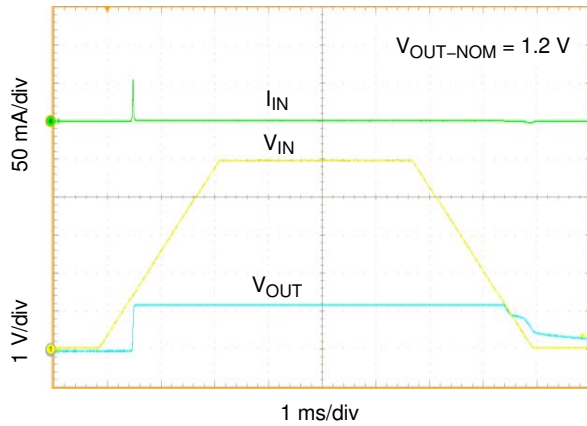

Figure 24. Turn-ON/OFF – VIN driven (slow)

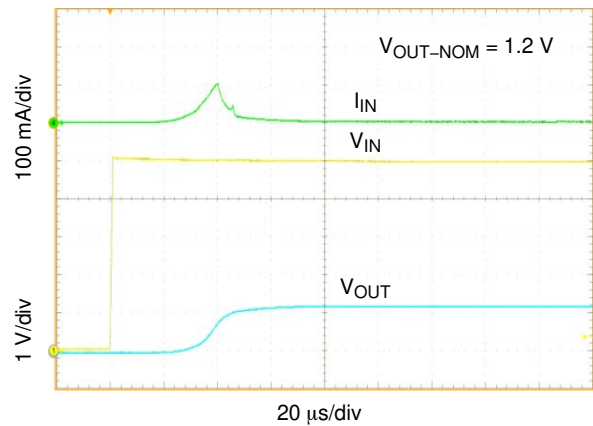

Figure 25. Turn-ON – VIN driven (fast)

TYPICAL CHARACTERISTICS

$V_{IN} = V_{OUT-NOM} + 0.5\text{ V}$ or $V_{IN} = 1.8\text{ V}$, whichever is greater, $V_{EN} = 1.2\text{ V}$, $I_{OUT} = 1\text{ mA}$, $C_{IN} = C_{OUT} = 1.0\text{ }\mu\text{F}$, $T_J = 25^\circ\text{C}$.

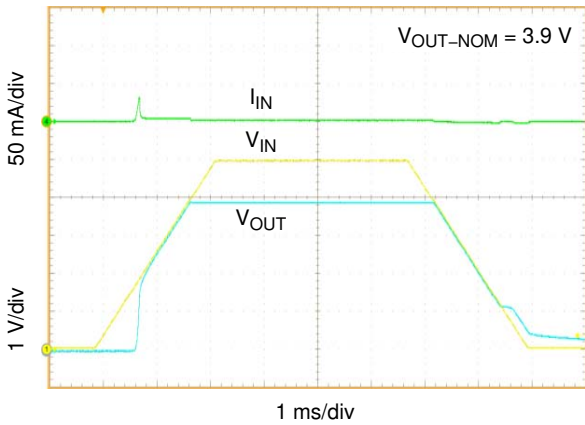

Figure 26. Turn-ON/OFF – VIN driven (slow)

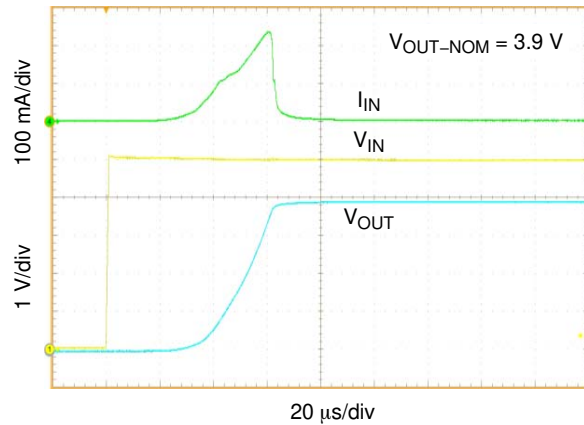

Figure 27. Turn-ON – VIN driven (fast)

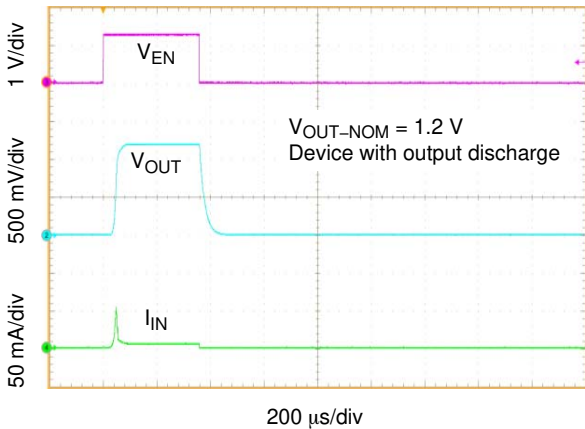

Figure 28. Turn-ON/OFF – EN driven

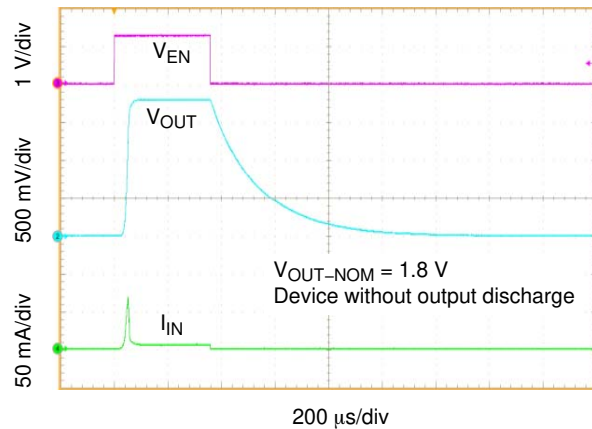

Figure 29. Turn-ON/OFF – EN driven

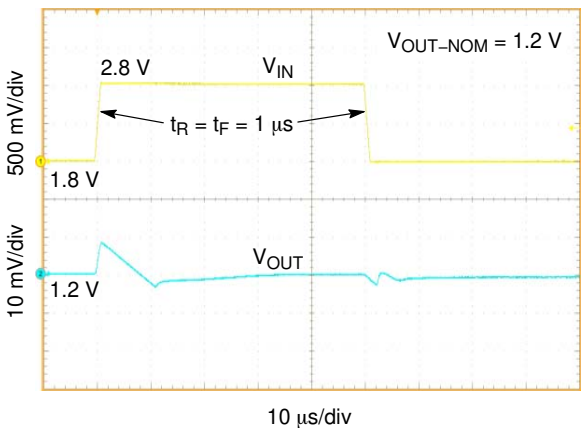

Figure 30. Line Transient Response

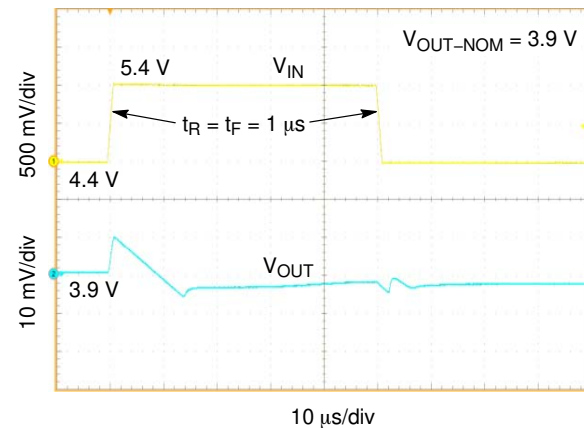

Figure 31. Line Transient Response

NCP186

TYPICAL CHARACTERISTICS

$V_{IN} = V_{OUT-NOM} + 0.5 \text{ V}$ or $V_{IN} = 1.8 \text{ V}$, whichever is greater, $V_{EN} = 1.2 \text{ V}$, $I_{OUT} = 1 \text{ mA}$, $C_{IN} = C_{OUT} = 1.0 \mu\text{F}$, $T_J = 25^\circ\text{C}$.

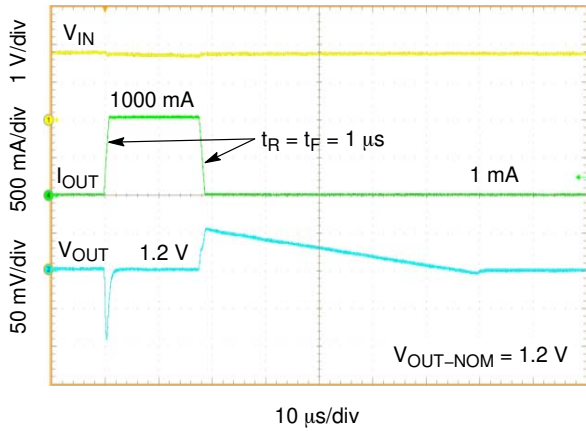

Figure 32. Load Transient Response

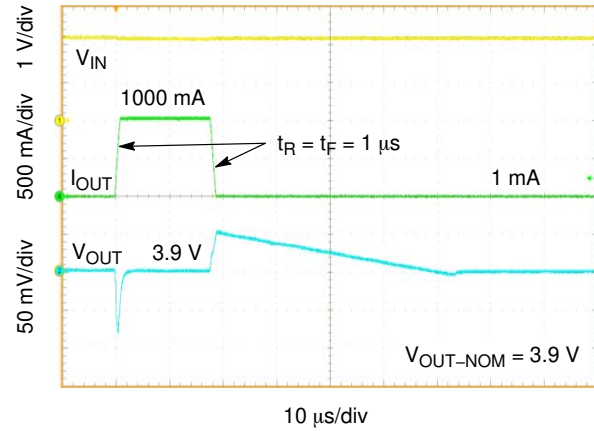

Figure 33. Load Transient Response

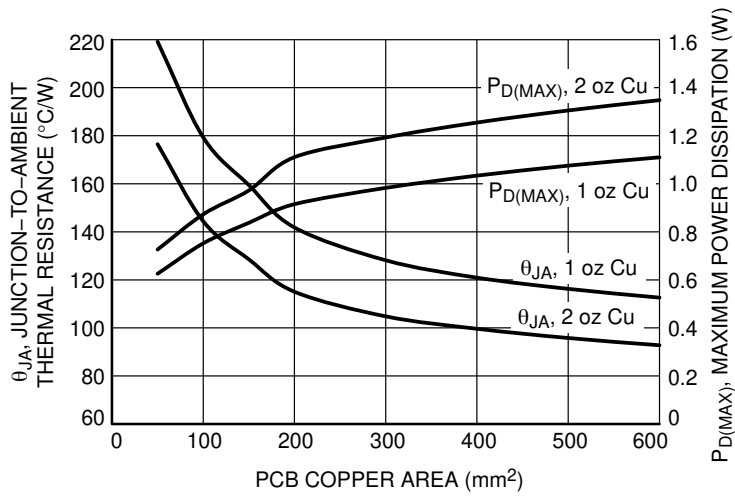

Figure 34. θ_{JA} and $P_{D(MAX)}$ vs. Copper Area

APPLICATIONS INFORMATION

General

The NCP186 is a high performance 1 A low dropout linear regulator (LDO) delivering excellent noise and dynamic performance. Thanks to its adaptive ground current behavior the device consumes only 90 μA typ. of quiescent current (no-load condition).

The regulator features low noise of 48 μV_{RMS} , PSRR of 75 dB at 1 kHz and very good line/load transient performance. Such excellent dynamic parameters, small dropout voltage and small package size make the device an ideal choice for powering the precision noise sensitive circuitry in portable applications.

A logic EN input provides ON/OFF control of the output voltage. When the EN is low the device consumes as low as 100 nA typ. from the IN pin.

The device is fully protected in case of output overload, output short circuit condition or overheating, assuring a very robust design.

Input Capacitor Selection (C_{IN})

Input capacitor connected as close as possible is necessary to ensure device stability. The X7R or X5R capacitor should be used for reliable performance over temperature range. The value of the input capacitor should be 1 μF or greater for the best dynamic performance. This capacitor will provide a low impedance path for unwanted AC signals or noise modulated onto the input voltage.

There is no requirement for the ESR of the input capacitor but it is recommended to use ceramic capacitor for its low ESR and ESL. A good input capacitor will limit the influence of input trace inductance and source resistance during load current changes.

Output Capacitor Selection (C_{OUT})

The LDO requires an output capacitor connected as close as possible to the output and ground pins. The recommended capacitor value is 1 μF , ceramic X7R or X5R type due to its low capacitance variations over the specified temperature range. The LDO is designed to remain stable with minimum effective capacitance of 0.8 μF . When selecting the capacitor the changes with temperature, DC bias and package size needs to be taken into account. Especially for small package size capacitors such as 0201 the effective capacitance drops rapidly with the applied DC bias voltage (refer the capacitor's datasheet for details).

There is no requirement for the minimum value of equivalent series resistance (ESR) for the C_{OUT} but the maximum value of ESR should be less than 0.5 Ω . Larger capacitance and lower ESR improves the load transient response and high frequency PSRR. Only ceramic capacitors are recommended, the other types like tantalum capacitors not due to their large ESR.

Enable Operation

The LDO uses the EN pin to enable/disable its operation and to deactivate/activate the output discharge function (A-version only).

If the EN pin voltage is $< 0.4\text{ V}$ the device is disabled and the pass transistor is turned off so there is no current flow between the IN and OUT pins. On A-version the active discharge transistor is active so the output voltage is pulled to GND through 34 Ω (typ.) resistor.

If the EN pin voltage is $> 1.0\text{ V}$ the device is enabled and regulates the output voltage. The active discharge transistor is turned off.

The EN pin has internal pull-down current source with value of 150 nA typ. which assures the device is turned off when the EN pin is unconnected. In case when the EN function isn't required the EN pin should be tied directly to IN pin.

Output Current Limit

Output current is internally limited to a 1.4 A typ. The LDO will source this current when the output voltage drops down from the nominal output voltage (test condition is $V_{\text{OUT-NOM}} - 100\text{mV}$). If the output voltage is shorted to ground, the short circuit protection will limit the output current to 1.4 A typ. The current limit and short circuit protection will work properly over the whole temperature and input voltage ranges. There is no limitation for the short circuit duration.

Thermal Shutdown

When the LDO's die temperature exceeds the thermal shutdown threshold value the device is internally disabled. The IC will remain in this state until the die temperature decreases by value called thermal shutdown hysteresis. Once the IC temperature falls this way the LDO is back enabled. The thermal shutdown feature provides the protection against overheating due to some application failure and it is not intended to be used as a normal working function.

Power Dissipation

Power dissipation caused by voltage drop across the LDO and by the output current flowing through the device needs to be dissipated out from the chip. The maximum power dissipation is dependent on the PCB layout, number of used Cu layers, Cu layers thickness and the ambient temperature. The maximum power dissipation can be computed by following equation:

$$P_{\text{D(MAX)}} = \frac{T_{\text{J}} - T_{\text{A}}}{\theta_{\text{JA}}} \text{ [W]} \quad (\text{eq. 1})$$

Where $(T_{\text{J}} - T_{\text{A}})$ is the temperature difference between the junction and ambient temperatures and θ_{JA} is the thermal resistance (dependent on the PCB as mentioned above).

The power dissipated by the LDO for given application conditions can be calculated by the next equation:

$$P_D = V_{IN} \cdot I_{GND} + (V_{IN} - V_{OUT}) \cdot I_{OUT} [W] \quad (\text{eq. 2})$$

Where I_{GND} is the LDO's ground current, dependent on the output load current.

Connecting the exposed pad and N/C pin to a large ground planes helps to dissipate the heat from the chip.

The relation of θ_{JA} and $P_{D(MAX)}$ to PCB copper area and Cu layer thickness could be seen on the Figure 34.

Reverse Current

The PMOS pass transistor has an inherent body diode which will be forward biased in the case when $V_{OUT} > V_{IN}$. Due to this fact in cases, where the extended reverse current condition can be anticipated the device may require additional external protection.

Power Supply Rejection Ratio

The LDO features very high power supply rejection ratio. The PSRR at higher frequencies (in the range above

100 kHz) can be tuned by the selection of C_{OUT} capacitor and proper PCB layout. A simple LC filter could be added to the LDO's IN pin for further PSRR improvement.

Enable Turn-On Time

The enable turn-on time is defined as the time from EN assertion to the point in which V_{OUT} will reach 98% of its nominal value. This time is dependent on various application conditions such as $V_{OUT-NOM}$, C_{OUT} and T_A .

PCB Layout Recommendations

To obtain good transient performance and good regulation characteristics place C_{IN} and C_{OUT} capacitors as close as possible to the device pins and make the PCB traces wide. In order to minimize the solution size, use 0402 or 0201 capacitors size with appropriate effective capacitance.

Larger copper area connected to the pins will also improve the device thermal resistance. The actual power dissipation can be calculated from the equation above (Power Dissipation section). Exposed pad and N/C pin should be tied to the ground plane for good power dissipation.

NCP186

PACKAGE DIMENSIONS

XDFN8 1.6x1.2, 0.4P CASE 711AS ISSUE A

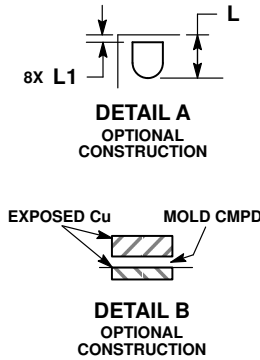
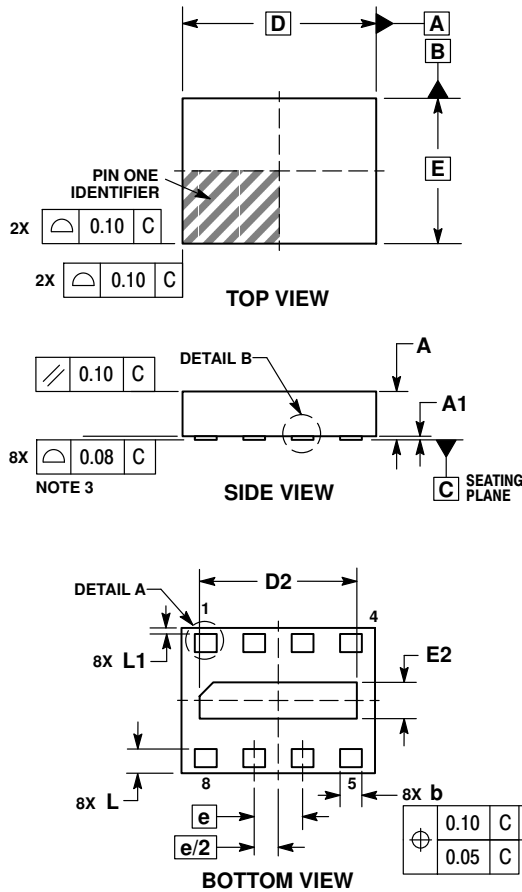

NOTES:

1. DIMENSIONING AND TOLERANCING PER ASME Y14.5M, 1994.
2. CONTROLLING DIMENSION: MILLIMETERS.
3. COPLANARITY APPLIES TO THE EXPOSED PAD AS WELL AS THE TERMINALS.

DIM	MILLIMETERS	
	MIN	MAX
A	0.30	0.45
A1	0.00	0.05
b	0.13	0.23
D	1.60 BSC	
D2	1.20	1.40
E	1.20 BSC	
E2	0.20	0.40
e	0.40 BSC	
L	0.15	0.25
L1	0.05 REF	

RECOMMENDED MOUNTING FOOTPRINT*

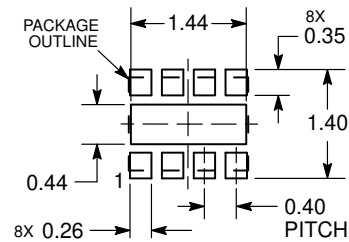

DIMENSIONS: MILLIMETERS

*For additional information on our Pb-Free strategy and soldering details, please download the ON Semiconductor Soldering and Mounting Techniques Reference Manual, SOLDERRM/D.

ON Semiconductor and the are registered trademarks of Semiconductor Components Industries, LLC (SCILLC) or its subsidiaries in the United States and/or other countries. SCILLC owns the rights to a number of patents, trademarks, copyrights, trade secrets, and other intellectual property. A listing of SCILLC's product/patent coverage may be accessed at www.onsemi.com/site/pdf/Patent-Marking.pdf. SCILLC reserves the right to make changes without further notice to any products herein. SCILLC makes no warranty, representation or guarantee regarding the suitability of its products for any particular purpose, nor does SCILLC assume any liability arising out of the application or use of any product or circuit, and specifically disclaims any and all liability, including without limitation special, consequential or incidental damages. "Typical" parameters which may be provided in SCILLC data sheets and/or specifications can and do vary in different applications and actual performance may vary over time. All operating parameters, including "Typicals" must be validated for each customer application by customer's technical experts. SCILLC does not convey any license under its patent rights nor the rights of others. SCILLC products are not designed, intended, or authorized for use as components in systems intended for surgical implant into the body, or other applications intended to support or sustain life, or for any other application in which the failure of the SCILLC product could create a situation where personal injury or death may occur. Should Buyer purchase or use SCILLC products for any such unintended or unauthorized application, Buyer shall indemnify and hold SCILLC and its officers, employees, subsidiaries, affiliates, and distributors harmless against all claims, costs, damages, and expenses, and reasonable attorney fees arising out of, directly or indirectly, any claim of personal injury or death associated with such unintended or unauthorized use, even if such claim alleges that SCILLC was negligent regarding the design or manufacture of the part. SCILLC is an Equal Opportunity/Affirmative Action Employer. This literature is subject to all applicable copyright laws and is not for resale in any manner.

PUBLICATION ORDERING INFORMATION

LITERATURE FULFILLMENT:

Literature Distribution Center for ON Semiconductor
P.O. Box 5163, Denver, Colorado 80217 USA
Phone: 303-675-2175 or 800-344-3860 Toll Free USA/Canada
Fax: 303-675-2176 or 800-344-3867 Toll Free USA/Canada
Email: orderlit@onsemi.com

N. American Technical Support: 800-282-9855 Toll Free
USA/Canada
Europe, Middle East and Africa Technical Support:
Phone: 421 33 790 2910
Japan Customer Focus Center
Phone: 81-3-5817-1050

ON Semiconductor Website: www.onsemi.com

Order Literature: <http://www.onsemi.com/orderlit>

For additional information, please contact your local Sales Representative