



Chipsmall Limited consists of a professional team with an average of over 10 year of expertise in the distribution of electronic components. Based in Hongkong, we have already established firm and mutual-benefit business relationships with customers from,Europe,America and south Asia,supplying obsolete and hard-to-find components to meet their specific needs.

With the principle of “Quality Parts,Customers Priority,Honest Operation,and Considerate Service”,our business mainly focus on the distribution of electronic components. Line cards we deal with include Microchip,ALPS,ROHM,Xilinx,Pulse,ON,Everlight and Freescale. Main products comprise IC,Modules,Potentiometer,IC Socket,Relay,Connector.Our parts cover such applications as commercial,industrial, and automotives areas.

We are looking forward to setting up business relationship with you and hope to provide you with the best service and solution. Let us make a better world for our industry!



Contact us

Tel: +86-755-8981 8866 Fax: +86-755-8427 6832

Email & Skype: info@chipsmall.com Web: www.chipsmall.com

Address: A1208, Overseas Decoration Building, #122 Zhenhua RD., Futian, Shenzhen, China



NCP2823AGEVB, NCP2823BGEVB

NCP2823 Series Evaluation Board User's Manual



ON Semiconductor®

<http://onsemi.com>

EVAL BOARD USER'S MANUAL

Overview

The NCP2823A/B are cost effective mono audio power amplifiers designed for portable electronic devices. NCP2823A is optimized for 8 Ω operation and NCP2823B can operate with speaker impedance down to 4.0 Ω . For Instance, NCP2823B is capable of delivering 3 W of continuous average power to a 4.0 Ω from a 5.0 V supply in a Bridge Tied Load (BTL) configuration. Under the same conditions, NCP2823A can provide 1.5 W to an 8.0 Ω BTL load with less than 1% THD+N. For cellular handsets or

PDA's it offers space and cost savings because no output filter is required when using inductive transducers. With more than 95% efficiency and very low shutdown current, it increases the lifetime of your battery and drastically lowers the junction temperature.

The intent of the evaluation boards is to illustrate typical operation of the NCP2823 device for laboratory characterization. The NCP2823 Series Evaluation Board schematic is depicted in Figure 3.

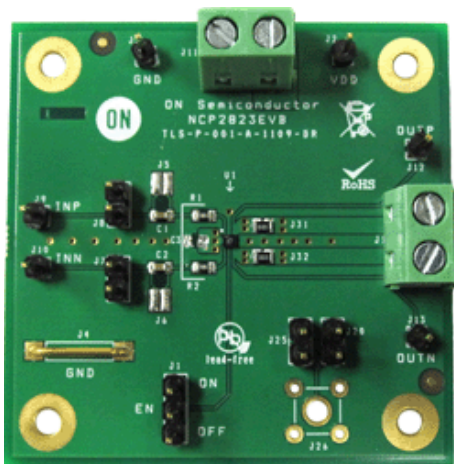

Figure 1. NCP2823AGEVB Board Picture

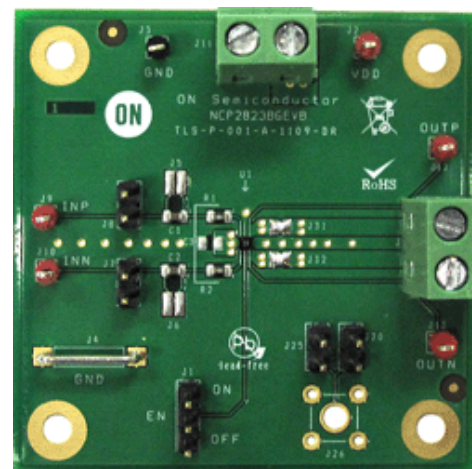

Figure 2. NCP2823BGEVB Board Picture

NCP2823AGEVB, NCP2823BGEVB

BOARD SCHEMATIC

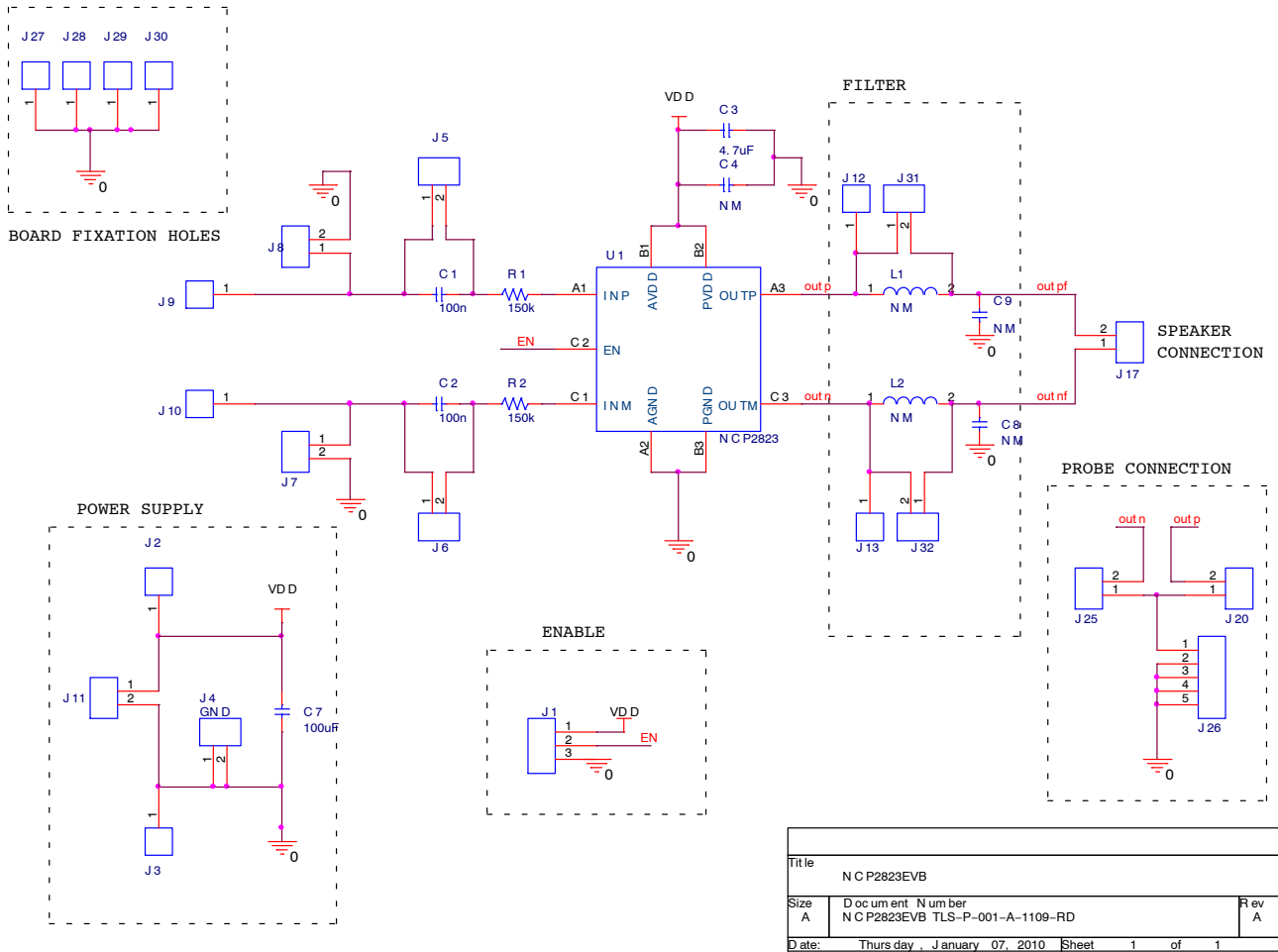

Figure 3. NCP2823 Series Evaluation Board Schematic

OPERATION

The operating power supply of the NCP2823 is from 2.5 to 5.5 V. The absolute maximum input voltage is 7.0 V. A power supply set to 3.6 V and current limit set to at least 1.5 A must be connected to J11 connector to powering the NCP2823 Series Evaluation Board. Also to compensate for parasitic inductance of wires between the power supply and the evaluation board it is highly recommended to connect a 470 μ F electrolytic capacitor to bypass J11 terminal. Like this the device can be evaluate under powering condition very similar that battery power supplies.

Performances of EVB Solution

To be as close as possible with final handset application, the design of this power conversion solution used small size footprints where possible. Changing components may positively or negatively impact the evaluation board performance, illustrated in Figure 4 to 9. For more information please refer to the NCP2823 datasheet.

NCP2823AGEVB, NCP2823BGEVB

Table 1. BOARD CONNECTIONS

INPUT POWER

Symbol	Descriptions
J11-1	This is the positive connection for power supply. The leads (positive + ground) to the input supply should be twisted and kept as short as possible.
J11-2	This is the return connection for the power supply (Ground signal)
J4	Ground clip

AUDIO

Symbol	Descriptions
J9	Positive Audio input
J10	Negative Audio input
J17-2	Positive Audio output
J17-1	Negative Audio output

SWITCHES SETUP

Symbol	Switch Descriptions
J1	Enable
J5	Short input capacitor on positive input
J6	Short input capacitor on negative input
J7	Connect the positive audio input to Gnd
J8	Connect the negative audio input to Gnd
J31	Short filter on positive output
J32	Short filter on negative output
J25	Connect negative output to Probe connection (J26)
J20	Connect Positive output to Probe connection (J26)

TEST POINT

Symbol	Switch Descriptions
J3	This test point is directly connected to the GND
J2	This test point is directly connected to the Vdd pin
J9	This test point is connected to the positive audio input
J10	This test point is connected to the negative audio input
J12	This test point is connected to the positive audio output
J13	This test point is connected to the negative audio output
J26	Probe connection

NCP2823AGEVB, NCP2823BGEVB

TYPICAL OPERATING CHARACTERISTICS

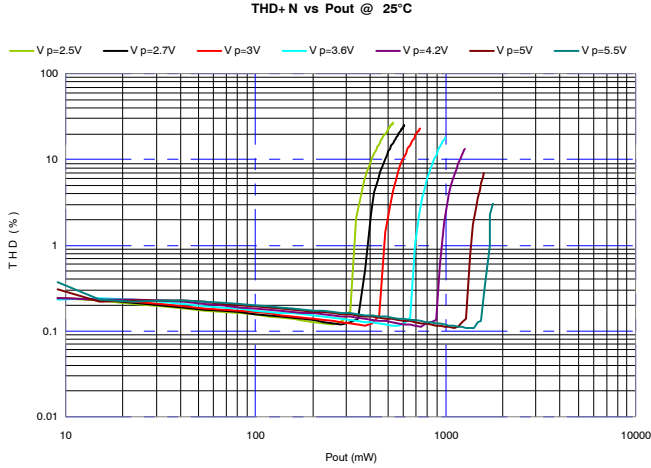

Figure 4. THD vs. P_{OUT} , $R_I = 8 \Omega$, $f = 1 \text{ kHz}$

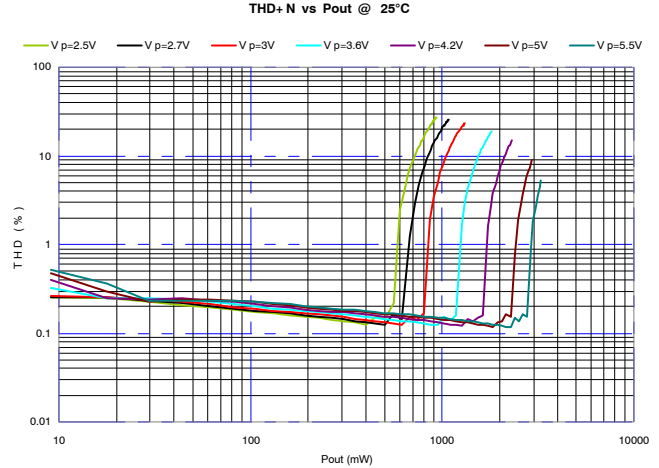

Figure 5. THD vs. P_{OUT} , $R_I = 4 \Omega$, $f = 1 \text{ kHz}$

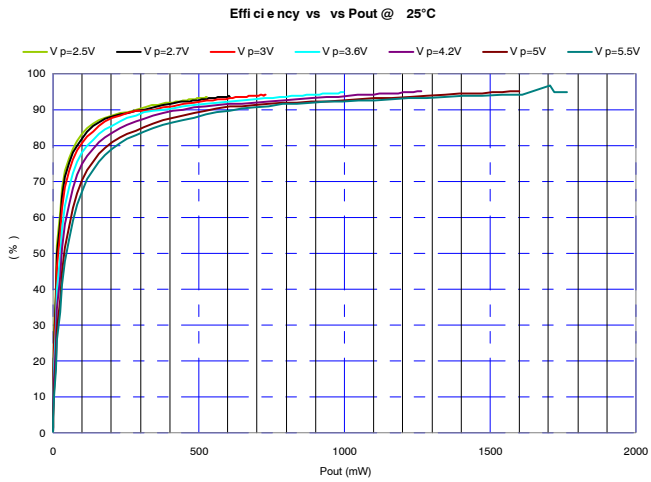

Figure 6. Efficiency vs. P_{OUT} , $R_I = 8 \Omega$, $f = 1 \text{ kHz}$

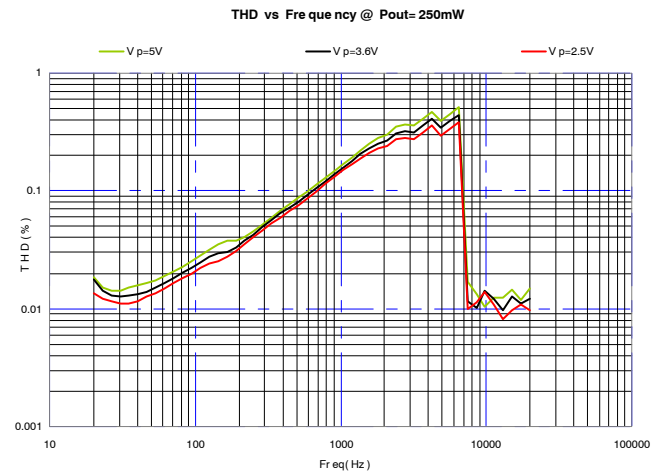

Figure 7. THD vs. Frequency, $R_I = 8 \Omega$, $P_{OUT} = 250 \text{ mW}$

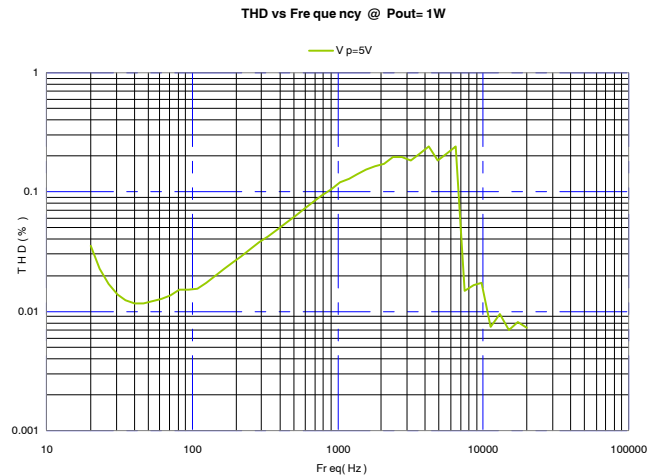

Figure 8. THD vs. Frequency, $R_I = 8 \Omega$, $P_{OUT} = 1 \text{ W}$

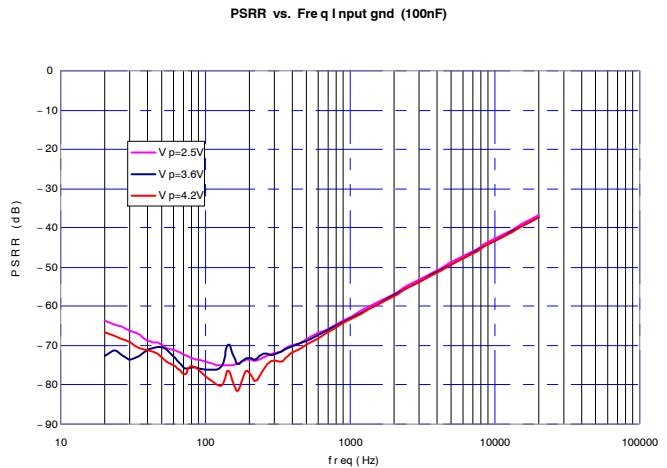

Figure 9. PSRR vs. Frequency

NCP2823AGEVB, NCP2823BGEVB

PCB LAYOUT

As with all Class D amplifier, care must have been observed to place the components on the PCB and layout the critical nodes. The evaluation board is made of 4 PCB layers where first internal layer is a GND. Figure 10, Figure 12 and

Figure 13 show the layout of the NCP2823 Series evaluation board. For more specific layout guidelines please refer to the NCP2823 datasheet.

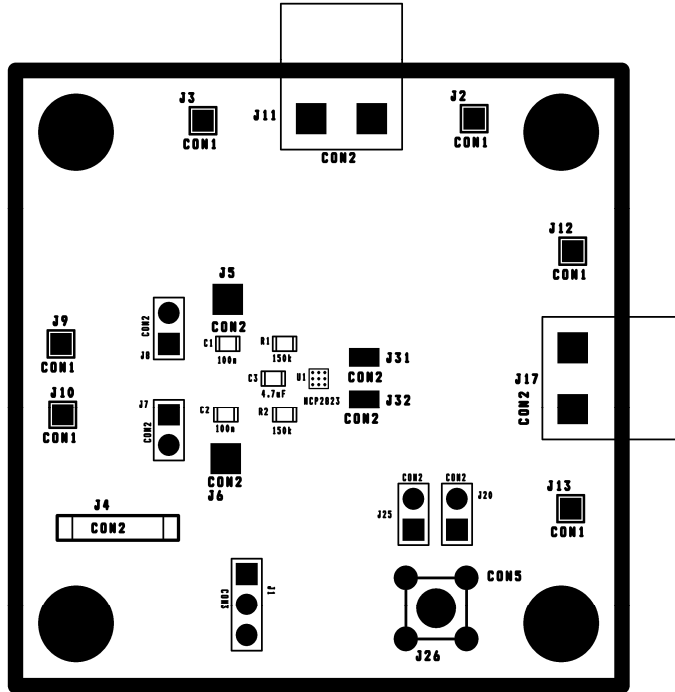

Figure 10. Assembly Layer TOP

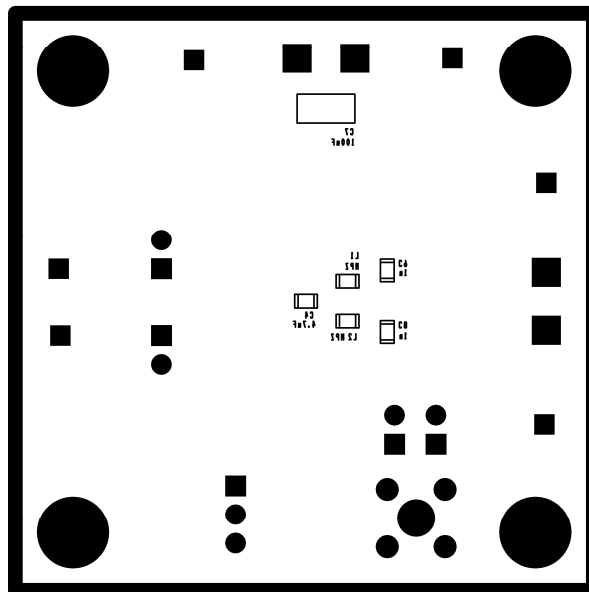

Figure 11. Assembly Layer BOTTOM

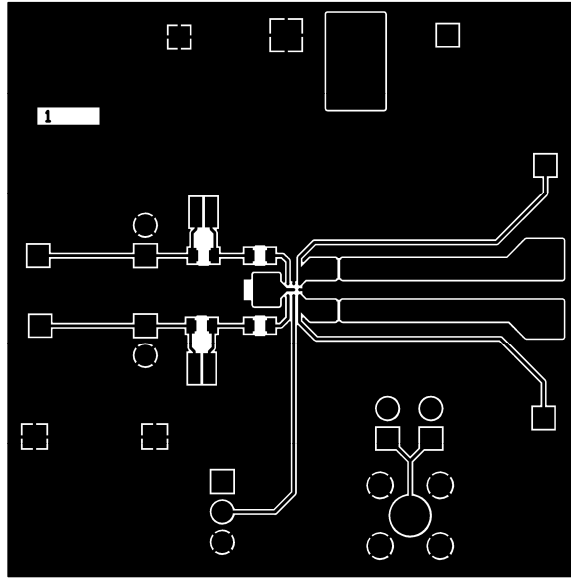

Figure 12. Top Layer Routing

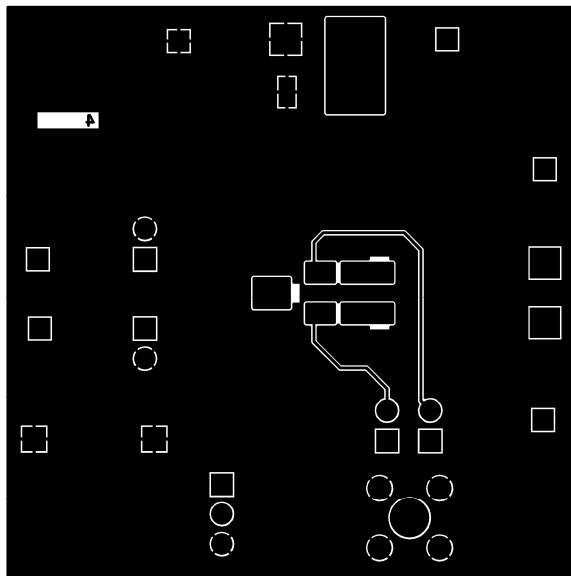

Figure 13. Bottom Layer Routing

NCP2823AGEVB, NCP2823BGEVB

Table 2. BILL OF MATERIALS

Qty	Ref Des.	Description	Size	Manufacturer	Part Number
1	U1	NCP2823	CSP-9 1.45 x 1.45 mm	ON Semiconductor	NCP2823
2	C1, C2	Capacitor, Ceramic 100 nF	0603	KEMET	C0603C104K5RAC
2	C4	Capacitor, Ceramic 4.7 μ F 6.3 V	0603	KEMET	C0603C475K9PAC
2	R1, R2	Resistor 150k 1%	0603	Std	Any supplier possible
2	J11, J17	Mal. SL5.08/2/90B plus Fem. BLZ 5.08/2		Weidmuller	SL5.08/2/90 + BLZ 5.08/2
3	J1	Header 3 pin, 100 mil spacing	0.100 x 2	Std	Std
2	J7, J8	Header 2 pin, 100 mil spacing	0.100 x 2	Std	Std
1	J7	GND Connection		Std	Std
9	J2, J3, J9, J10, J12, J13	Test Point		Std	Std
2	J31, J32	Soldering point must be connected			
1	PCB	PCB 2.0 in x 2.0 in x 1.0 mm, 4 Layers		Any	TLS-P-001-A-1109-RD

NOTE: Component J20, J25, J26, L1, L2, C8 and C9 are not mounted on this demokit.

ASSEMBLY TEST PROCEDURE

A power supply set to 3.6 V and current limit set to at least 1.5 A must be connected to J15 connector to powering the NCP2823 Series evaluation board. Also to compensate for parasitic inductance of wires between the power supply and the evaluation board it is highly recommended to connect a 470 μ F electrolytic capacitor to bypass J11 terminal. Like this the device can be evaluate under powering condition very similar that battery power supplies.

These tests are provided in order to guarantee a good assembly of the NCP2823 on its dedicated board, it do not consist in parametric test which is already done at chip level.

SHUTDOWN TEST

Switches setup for shutdown test:

Symbol	Switch Description
J1	Must be connected to ground (low side)

*All other switches must be kept floating

Tests:

1. Set the switches in the configuration
2. Power the board with a 3.6 V power supply limited at 1.5A and bypassed by a 470 μ F electrolytic capacitor.
3. Measure the current on the power supply (must be inferior to 1 μ A)

Wake up test

Switches setup for wire mode test:

Symbol	Switch Description
J1	Must be connected to VDD (high side)

*All other switches must be kept floating

Tests:

4. Set the switches in the configuration
5. Power the board with a 3.6 V power supply limited at 1.5 A and bypassed by a 470 μ F electrolytic capacitor.
6. Measure DC Output voltage on J12 on J13 and GND. DC Voltage must be equal to 1.8 V
7. Measure DC input voltage on J5-2 on J6-2 and GND. DC Voltage must be equal to 1.26 V

SUMMARY

Test	Measurement	Switch Description
Shutdown test	I Supply	I < 1 μ A
Wake up test	VOUTP, VOUTN VJ9, VJ10	VDC = 1.8 V VDC = 1.26 V

NOTE: For each board a Test Result Table must be fully completed (see the next page)

NCP2823AGEVB, NCP2823BGEVB

TEST RESULT TABLE

NCP2823 Assembly Test				
Date	Operator Name			
Board Serial Number				
Test No.	Test Name	Results	Value	
1	Shutdown mode test	I Supply		
2	Wake up test	VoutP, VoutN	1.8	
		VJ9, VJ10	1.26	

ON Semiconductor and **ON** are registered trademarks of Semiconductor Components Industries, LLC (SCILLC). SCILLC reserves the right to make changes without further notice to any products herein. SCILLC makes no warranty, representation or guarantee regarding the suitability of its products for any particular purpose, nor does SCILLC assume any liability arising out of the application or use of any product or circuit, and specifically disclaims any and all liability, including without limitation special, consequential or incidental damages. "Typical" parameters which may be provided in SCILLC data sheets and/or specifications can and do vary in different applications and actual performance may vary over time. All operating parameters, including "Typicals" must be validated for each customer application by customer's technical experts. SCILLC does not convey any license under its patent rights nor the rights of others. SCILLC products are not designed, intended, or authorized for use as components in systems intended for surgical implant into the body, or other applications intended to support or sustain life, or for any other application in which the failure of the SCILLC product could create a situation where personal injury or death may occur. Should Buyer purchase or use SCILLC products for any such unintended or unauthorized application, Buyer shall indemnify and hold SCILLC and its officers, employees, subsidiaries, affiliates, and distributors harmless against all claims, costs, damages, and expenses, and reasonable attorney fees arising out of, directly or indirectly, any claim of personal injury or death associated with such unintended or unauthorized use, even if such claim alleges that SCILLC was negligent regarding the design or manufacture of the part. SCILLC is an Equal Opportunity/Affirmative Action Employer. This literature is subject to all applicable copyright laws and is not for resale in any manner.

PUBLICATION ORDERING INFORMATION

LITERATURE FULFILLMENT:

Literature Distribution Center for ON Semiconductor
P.O. Box 5163, Denver, Colorado 80217 USA
Phone: 303-675-2175 or 800-344-3860 Toll Free USA/Canada
Fax: 303-675-2176 or 800-344-3867 Toll Free USA/Canada
Email: orderlit@onsemi.com

N. American Technical Support: 800-282-9855 Toll Free
USA/Canada
Europe, Middle East and Africa Technical Support:
Phone: 421 33 790 2910
Japan Customer Focus Center
Phone: 81-3-5817-1050

ON Semiconductor Website: www.onsemi.com

Order Literature: <http://www.onsemi.com/orderlit>

For additional information, please contact your local Sales Representative