



Chipsmall Limited consists of a professional team with an average of over 10 year of expertise in the distribution of electronic components. Based in Hongkong, we have already established firm and mutual-benefit business relationships with customers from,Europe,America and south Asia,supplying obsolete and hard-to-find components to meet their specific needs.

With the principle of “Quality Parts,Customers Priority,Honest Operation,and Considerate Service”,our business mainly focus on the distribution of electronic components. Line cards we deal with include Microchip,ALPS,ROHM,Xilinx,Pulse,ON,Everlight and Freescale. Main products comprise IC,Modules,Potentiometer,IC Socket,Relay,Connector.Our parts cover such applications as commercial,industrial, and automotives areas.

We are looking forward to setting up business relationship with you and hope to provide you with the best service and solution. Let us make a better world for our industry!



## Contact us

Tel: +86-755-8981 8866 Fax: +86-755-8427 6832

Email & Skype: info@chipsmall.com Web: www.chipsmall.com

Address: A1208, Overseas Decoration Building, #122 Zhenhua RD., Futian, Shenzhen, China



# NCP391

## Positive Overvoltage Protection Controller with Internal Low $R_{ON}$ NMOS FET

The NCP391 is able to disconnect the systems from its output pin when wrong input operating conditions are detected. The system is positive overvoltage protected up to +28 V.

This device uses an internal NMOS and therefore, no external device is necessary, reducing the system cost and the PCB area of the application board.

The NCP391 is able to instantaneously disconnect the output from the input, due to integrated Low  $R_{ON}$  Power NMOS, if the input voltage exceeds the overvoltage threshold (OVLO) or falls below the undervoltage threshold (UVLO).

At powerup ( $\overline{EN}$  pin = low level), the  $V_{out}$  turns on  $t_{on}$  time after the  $V_{in}$  exceeds the undervoltage threshold.

The NCP391 provides a negative going flag ( $\overline{FLAG}$ ) output, which alerts the system that a fault has occurred.

In addition, the device has ESD-protected input (15 kV Air) when bypassed with a 1.0  $\mu$ F or larger capacitor.

### Features

- Overvoltage Protection up to 28 V
- On-Chip Low  $R_{DS(on)}$  NMOS Transistor
- Internal Charge Pump
- Overvoltage Lockout (OVLO)
- Undervoltage Lockout (UVLO)
- Soft-Start
- Alert  $\overline{FLAG}$  Output
- Shutdown  $\overline{EN}$  Input
- Compliance to IEC61000-4-2 (Level 4)  
8.0 kV (Contact)  
15 kV (Air)
- ESD Ratings: Machine Model = B  
Human Body Model = 2
- WLCSP6 1.31x1.04 mm Package
- This is a Pb-Free Device

### Applications

- Cell Phones
- Camera Phones
- Digital Still Cameras
- Personal Digital Applications
- MP3 Players



ON Semiconductor®

<http://onsemi.com>



WLCSP6  
FCAL SUFFIX  
CASE 499BP

### MARKING DIAGRAM

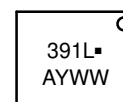

WLCSP6  
FCCAD SUFFIX  
CASE 567JW

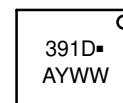

XXXX = Specific Device Code  
A = Assembly Location  
Y = Year  
WW = Work Week  
▪ = Pb-Free Package

### PIN CONNECTIONS

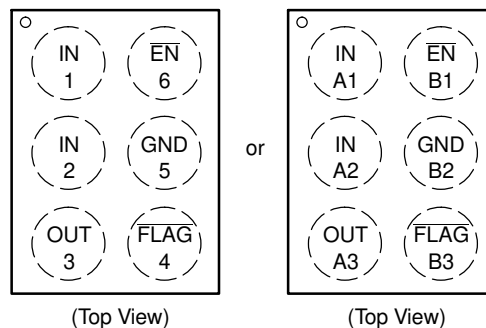

### ORDERING INFORMATION

See detailed ordering, marking and shipping information in the package dimensions section on page 12 of this data sheet.

# NCP391

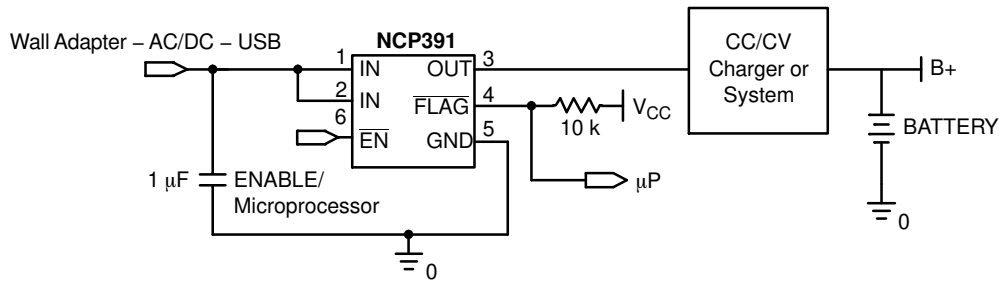

Figure 1. Typical Application Circuit

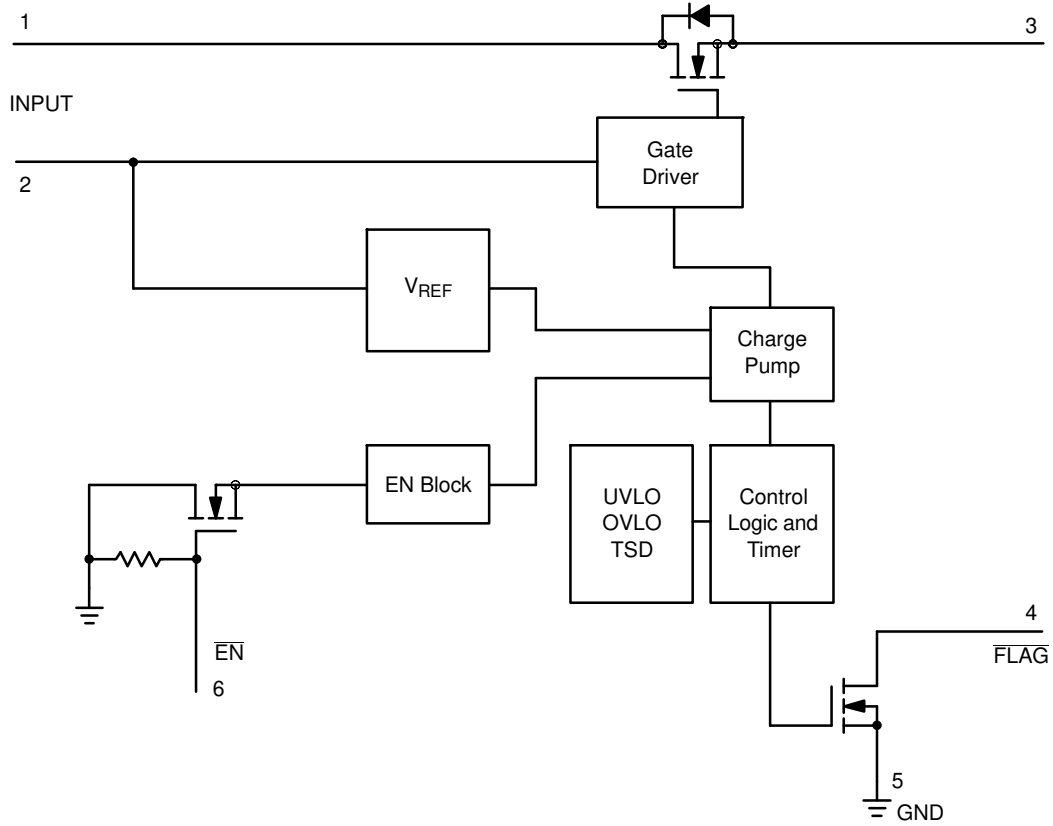

Figure 2. Functional Block Diagram

# NCP391

## PIN FUNCTION DESCRIPTION

Pin No.	Symbol	Function	Description
1, 2 or A1, A2	IN	INPUT	Input Voltage Pins. These pins are connected to the Wall Adapter (AC-DC, Vbus ..). A 1 $\mu$ F low ESR ceramic capacitor, or larger, must be connected between these pins and GND, as close as possible to the DUT. The two IN pins must be connected together to power supply. (See PCB recommendation for the pin7).
3 or A3	OUT	OUTPUT	Output Voltage Pins. This pin follows IN pins when “no fault” is detected.
4 or B3	FLAG	OUTPUT	Fault Indication Pin. This pin allows an external system to detect a fault on the IN pins. The FLAG pin goes low when input voltage exceeds OVLO threshold or drops below UVLO threshold or when TSD is exceeded. Since the FLAG pin is open drain functionality, an external pull-up resistor to V <sub>CC</sub> must be added. (Minimum 10 k $\Omega$ ).
5 or B2	GND	POWER	Ground
6 or B1	EN	INPUT	Enable Pin. The device enters in shutdown mode when this pin is tied to a high level. In this case the output is disconnected from the input. To allow normal functionality, the EN pin shall be connected to GND to a pull down or to a I/O pin. This pin does not have an impact on the fault detection.

## MAXIMUM RATINGS

Rating	Symbol	Value	Unit
Minimum Voltage (IN to GND)	V <sub>min<sub>in</sub></sub>	-0.3	V
Minimum Voltage (All others to GND)	V <sub>min</sub>	-0.3	V
Maximum Voltage (IN to GND)	V <sub>max<sub>in</sub></sub>	30	V
Maximum Voltage (All others to GND)	V <sub>max</sub>	7.0	V
Maximum Current (UVLO<V <sub>IN</sub> <OVLO)	I <sub>max</sub>	2.0	A
Maximum Peak Current (t $\leq$ 1 ms, T <sub>A</sub> = 85°C)	I <sub>max<sub>peak</sub></sub>	4.0	A
Thermal Resistance, Junction-to-Air (Note 1)	R <sub><math>\theta</math>JA</sub>	130	°C/W
Operating Ambient Temperature Range	T <sub>A</sub>	-40 to +85	°C
Storage Temperature Range	T <sub>stg</sub>	-65 to +150	°C
Junction Operating Temperature	T <sub>J</sub>	150	°C
ESD Withstand Voltage (IEC 61000-4-2) (input only) when bypassed with 1.0 $\mu$ F capacitor Human Body Model (HBM), Model = 2 (Note 2) Machine Model (MM) Model = B (Note 3)	V <sub>esd</sub>	15 Air, 8.0 Contact 2000 200	kV V V
Moisture Sensitivity	MSL	Level 1	-

Stresses exceeding Maximum Ratings may damage the device. Maximum Ratings are stress ratings only. Functional operation above the Recommended Operating Conditions is not implied. Extended exposure to stresses above the Recommended Operating Conditions may affect device reliability.

1. The R <sub>$\theta$ JA</sub> is highly dependent on the PCB heat sink area (connected to pin 7).
2. Human Body Model, 100 pF discharged through a 1.5 k $\Omega$  resistor following specification JESD22/A114.
3. Machine Model, 200 pF discharged through all pins following specification JESD22/A115.

# NCP391

**ELECTRICAL CHARACTERISTICS – NCP391FCALT2G** (Min/Max limits values ( $-40^{\circ}\text{C} < T_A < +85^{\circ}\text{C}$ ) and  $V_{in} = +5.0\text{ V}$ . Typical values are  $T_A = +25^{\circ}\text{C}$ , unless otherwise noted.)

Characteristic	Symbol	Conditions	Min	Typ	Max	Unit
Input Voltage Range	$V_{in}$	–	1.2	–	28	V
Undervoltage Lockout Threshold (Note 4) NCP391FCAL	UVLO	$V_{in}$ falls below UVLO threshold from 5 V to 2.7 V	2.8	2.95	3.1	V
Undervoltage Lockout Hysteresis	UVLO <sub>hyst</sub>	$V_{in}$ rises above UVLO + UVLO <sub>hyst</sub>	30	60	90	mV
Overvoltage Lockout Threshold (Note 4) NCP391FCAL	OVLO	$V_{in}$ rises above OVLO threshold	7.16	7.4	7.65	V
Overvoltage Lockout Hysteresis NCP391FCAL	OVLO <sub>hyst</sub>	$V_{in}$ falls below OVLO + OVLO <sub>hyst</sub>	50	100	150	mV
$V_{in}$ versus $V_{out}$ Resistance	$R_{DS(on)}$	$V_{in} = 5.0\text{ V}$ , $\overline{EN} = \text{GND}$ , Load connected to $V_{out}$	–	120	200	m $\Omega$
Supply Quiescent Current	$I_{dd}$	No load. $\overline{EN} = 5.0\text{ V}$	–	70	150	$\mu\text{A}$
		No load. $\overline{EN} = \text{Gnd}$	–	90	170	$\mu\text{A}$
UVLO Supply Current	$I_{dd_{uvlo}}$	$V_{IN} = 2.7\text{ V}$	–	60	–	$\mu\text{A}$
MOSFET Leakage	$I_{vdss}$	$V_{IN} = 28\text{ V}$	–	10	500	nA
$\overline{FLAG}$ Output Low Voltage	$V_{ol_{flag}}$	1.2 V < $V_{IN}$ < UVLO Sink 50 $\mu\text{A}$ on $\overline{FLAG}$ pin	–	20	400	mV
		$V_{IN} > \text{OVLO}$ Sink 1.0 mA on $\overline{FLAG}$ pin	–	–	400	mV
$\overline{FLAG}$ Leakage Current	$\overline{FLAG}_{leak}$	$\overline{FLAG}$ level = 5.0 V	–	1.0	–	nA
$\overline{EN}$ Voltage High	$V_{ih}$	–	1.2	–	–	V
$\overline{EN}$ Voltage Low	$V_{ol}$	–	–	–	0.4	V
$\overline{EN}$ Leakage Current	$\overline{EN}_{leak}$	$\overline{EN} = 5.0\text{ V}$ or GND	–	1.0	–	nA
Thermal Shutdown Temperature	$t_{SD}$	–	–	150	–	$^{\circ}\text{C}$
Thermal Shutdown Hysteresis	$t_{SDhyst}$	–	–	15	–	$^{\circ}\text{C}$

## TIMINGS

Startup Delay	$t_{on}$	From $V_{in} > \text{UVLO}$ to $V_{out} = 0.3\text{ V}$ (See Figures 3 & 7)	6.0	10	14	ms
$\overline{FLAG}$ Going Up Delay	$t_{start}$	From $V_{out} = 0.3\text{ V}$ to $\overline{FLAG} = 1.2\text{ V}$ (See Figures 3 & 9)	6.0	10	14	ms
Output Turn Off Time	$t_{off}$	From $V_{in} > \text{OVLO}$ to $V_{out} < = 0.3\text{ V}$ (See Figures 4 & 8) $V_{in}$ increasing from 5.0 V to 8.0 V at 3.0 V/ $\mu\text{s}$ Rload connected on $V_{out}$	–	1.5	5.0	$\mu\text{s}$
Alert Delay	$t_{stop}$	From $V_{in} > \text{OVLO}$ to $\overline{FLAG} < = 0.4\text{ V}$ (See Figures 4 & 10) $V_{in}$ increasing from 5.0 V to 8.0 V at 3.0 V/ $\mu\text{s}$ Rload connected on $V_{out}$	–	1.0	–	$\mu\text{s}$
Disable Time	$t_{dis}$	From $\overline{EN} > = 1.2\text{ V}$ to $V_{out} < 0.3\text{ V}$ Rload = 5.0 $\Omega$ (See Figures 5 & 12)	–	1.0	5.0	$\mu\text{s}$

NOTE: Electrical parameters are guaranteed by correlation across the full range of temperature.

4. Additional UVLO and OVLO thresholds ranging from UVLO and from OVLO can be manufactured. Contact your ON Semiconductor representative for availability.

# NCP391

**ELECTRICAL CHARACTERISTICS – NCP391FCCADT2G** (Min/Max limits values ( $-40^{\circ}\text{C} < T_A < +85^{\circ}\text{C}$ ) and  $V_{in} = +4.2\text{ V}$ . Typical values are  $T_A = +25^{\circ}\text{C}$ , unless otherwise noted.)

Characteristic	Symbol	Conditions	Min	Typ	Max	Unit
Input Voltage Range	$V_{in}$	–	1.2	–	28	V
Undervoltage Lockout Threshold (Note 5)	UVLO	$V_{in}$ falls below UVLO threshold from 4.2 V to 2.7 V	2.8	2.95	3.1	V
Undervoltage Lockout Hysteresis	UVLO <sub>hyst</sub>	$V_{in}$ rises above UVLO + UVLO <sub>hyst</sub>	30	60	90	mV
Overvoltage Lockout Threshold (Note 5)	OVLO	$V_{in}$ rises above OVLO threshold	4.8	4.95	5.1	V
Overvoltage Lockout Hysteresis	OVLO <sub>hyst</sub>	$V_{in}$ falls below OVLO + OVLO <sub>hyst</sub>	50	100	150	mV
$V_{in}$ versus $V_{out}$ Resistance	$R_{DS(on)}$	$V_{in} = 4.2\text{ V}$ , $\overline{EN} = \text{GND}$ , Load connected to $V_{out}$	–	120	200	m $\Omega$
Supply Quiescent Current	$I_{dd}$	No load. $\overline{EN} = 4.2\text{ V}$	–	70	150	$\mu\text{A}$
		No load. $\overline{EN} = \text{Gnd}$	–	90	170	$\mu\text{A}$
UVLO Supply Current	$I_{dd_{uvlo}}$	$V_{IN} = 2.7\text{ V}$	–	60	–	$\mu\text{A}$
MOSFET Leakage	$I_{vdss}$	$V_{IN} = 28\text{ V}$	–	10	500	nA
$\overline{FLAG}$ Output Low Voltage	$V_{ol_{flag}}$	1.2 V < $V_{IN}$ < UVLO Sink 50 $\mu\text{A}$ on $\overline{FLAG}$ pin	–	20	400	mV
		$V_{IN} > \text{OVLO}$ Sink 1.0 mA on $\overline{FLAG}$ pin	–	–	400	mV
$\overline{FLAG}$ Leakage Current	$\overline{FLAG}_{leak}$	$\overline{FLAG}$ level = 4.2 V	–	1.0	–	nA
$\overline{EN}$ Voltage High	$V_{ih}$	–	1.2	–	4.95	V
$\overline{EN}$ Voltage Low	$V_{ol}$	–	–	–	0.4	V
$\overline{EN}$ Leakage Current	$\overline{EN}_{leak}$	$\overline{EN} = 4.2\text{ V}$ or GND	–	1.0	–	nA
Thermal Shutdown Temperature	$t_{SD}$	–	–	150	–	$^{\circ}\text{C}$
Thermal Shutdown Hysteresis	$t_{SD_{hyst}}$	–	–	15	–	$^{\circ}\text{C}$

## TIMINGS

Startup Delay	$t_{on}$	From $V_{in} > \text{UVLO}$ to $V_{out} = 0.3\text{ V}$ (See Figures 3 & 7)	6.0	10	14	ms
$\overline{FLAG}$ Going Up Delay	$t_{start}$	From $V_{out} = 0.3\text{ V}$ to $\overline{FLAG} = 1.2\text{ V}$ (See Figures 3 & 9)	6.0	10	14	ms
Output Turn Off Time	$t_{off}$	From $V_{in} > \text{OVLO}$ to $V_{out} \leq 0.3\text{ V}$ (See Figures 4 & 8) $V_{in}$ increasing from 4.2 V to 8.0 V at 3.0 V/ $\mu\text{s}$ Rload connected on $V_{out}$	–	1.5	5.0	$\mu\text{s}$
Alert Delay	$t_{stop}$	From $V_{in} > \text{OVLO}$ to $\overline{FLAG} \leq 0.4\text{ V}$ (See Figures 4 & 10) $V_{in}$ increasing from 4.2 V to 8.0 V at 3.0 V/ $\mu\text{s}$ Rload connected on $V_{out}$	–	1.0	–	$\mu\text{s}$
Disable Time	$t_{dis}$	From $\overline{EN} > 1.2\text{ V}$ to $V_{out} < 0.3\text{ V}$ Rload = 5.0 $\Omega$ (See Figures 5 & 12)	–	1.0	5.0	$\mu\text{s}$

NOTE: Electrical parameters are guaranteed by correlation across the full range of temperature.

5. Additional UVLO and OVLO thresholds ranging from UVLO and from OVLO can be manufactured. Contact your ON Semiconductor representative for availability.

# NCP391

## TIMING DIAGRAMS

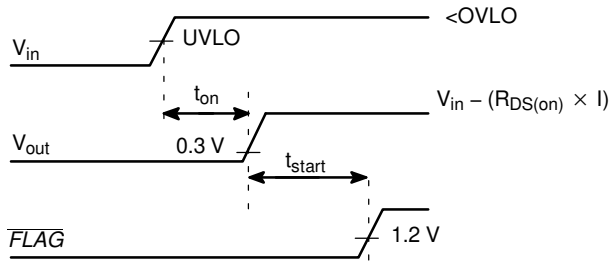

Figure 3. Startup

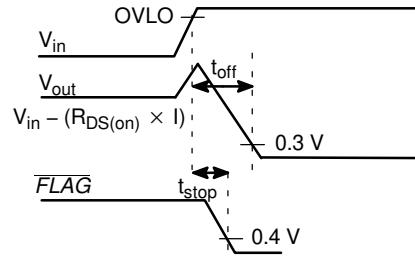

Figure 4. Shutdown on Overvoltage Detection

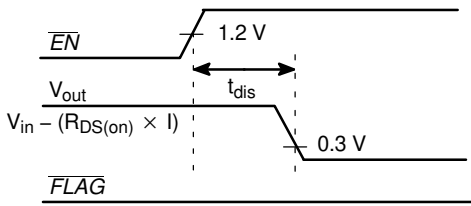

Figure 5. Disable on  $\overline{EN} = 1$

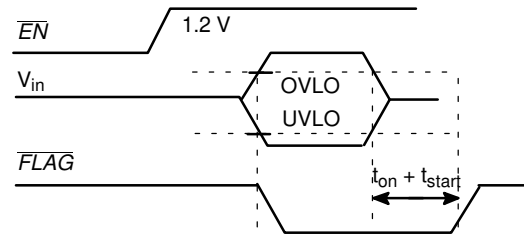
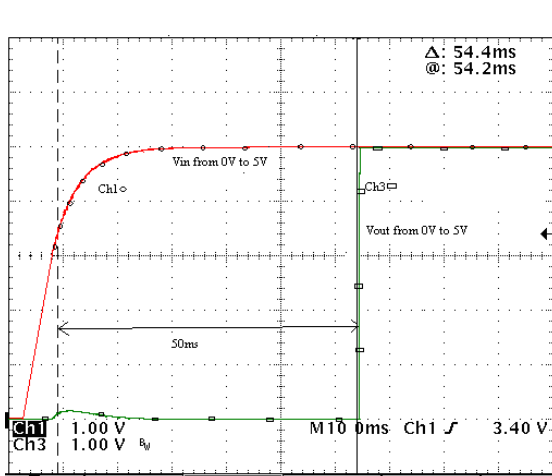

Figure 6.  $\overline{FLAG}$  Response with  $\overline{EN} = 1$



# NCP391

## TYPICAL OPERATING CHARACTERISTICS



**Figure 7. Startup**  
 $V_{in} = \text{Ch1}, V_{out} = \text{Ch3}$

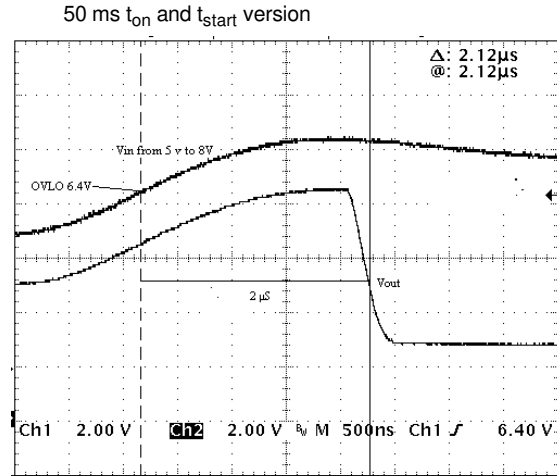

**Figure 8. Output Turn Off Time**  
 $V_{in} = \text{Ch1}, V_{out} = \text{Ch2}$

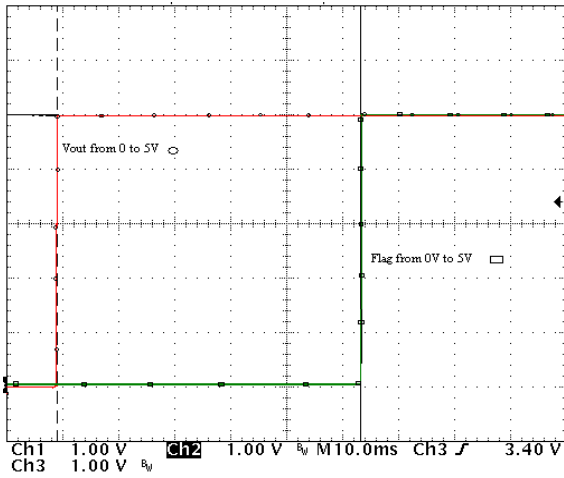

**Figure 9. FLAG Going Up Delay**  
 $V_{out} = \text{Ch3}, \text{FLAG} = \text{Ch2}$

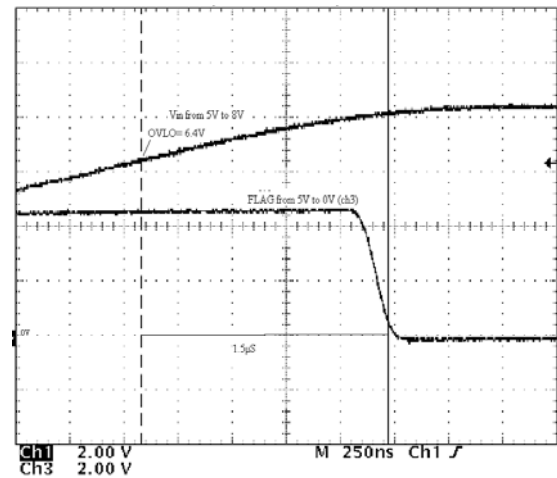

**Figure 10. Alert Delay**  
 $V_{out} = \text{Ch1}, \text{FLAG} = \text{Ch3}$

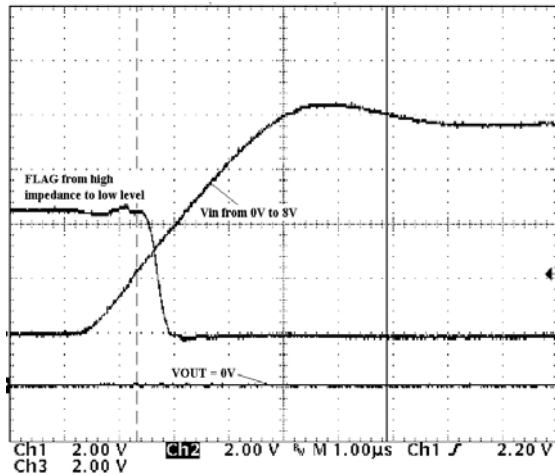

**Figure 11. Initial Overvoltage Delay**  
 $V_{in} = \text{Ch1}, V_{out} = \text{Ch2}, \text{FLAG} = \text{Ch3}$

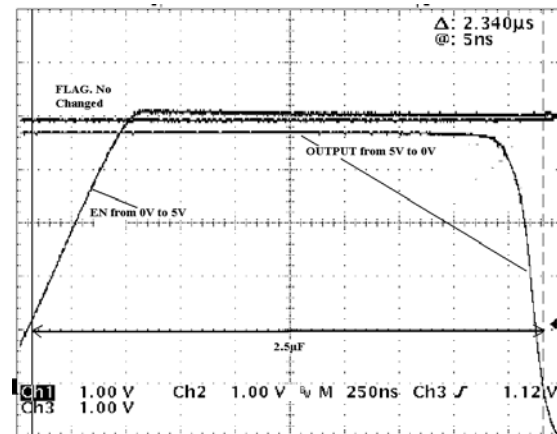

**Figure 12. Disable Time**  
 $\text{EN} = \text{Ch1}, V_{out} = \text{Ch2}, \text{FLAG} = \text{Ch3}$



# NCP391

## TYPICAL OPERATING CHARACTERISTICS

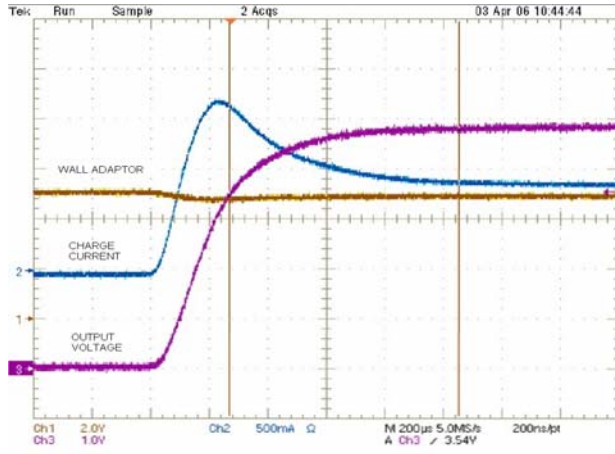

Figure 13. Inrush Current with  $C_{out} = 100 \mu F$ ,  $I_{charge} = 1 A$ , Output Wall Adaptor Inductance  $1 \mu H$

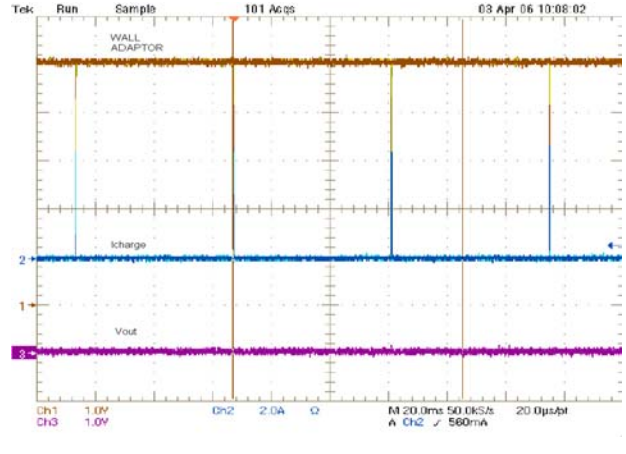

Figure 14. Output Short Circuit

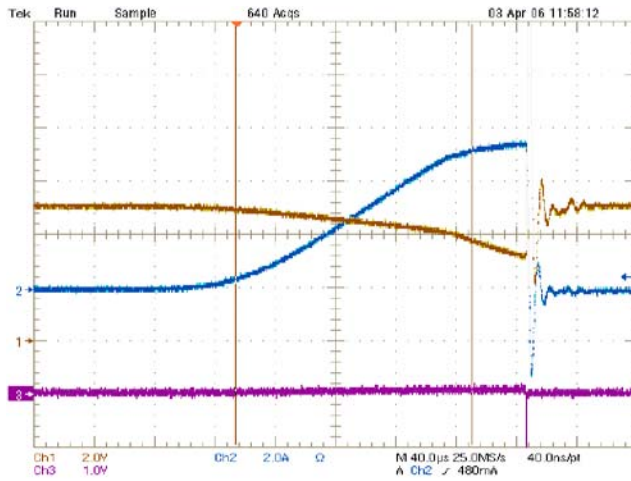

Figure 15. Output Short Circuit (Zoom Fig. 14)

# NCP391

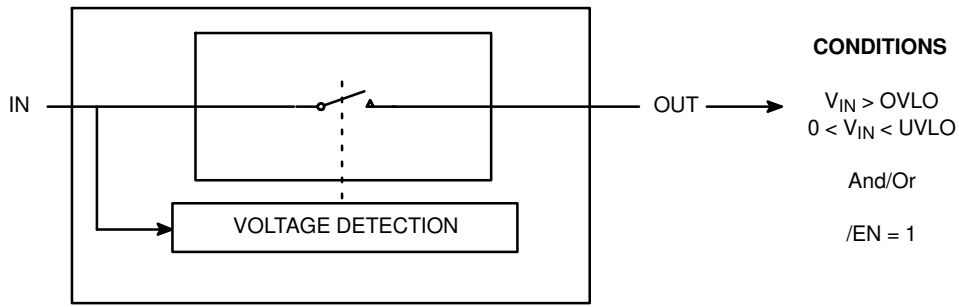

Figure 16. Simplified Diagram

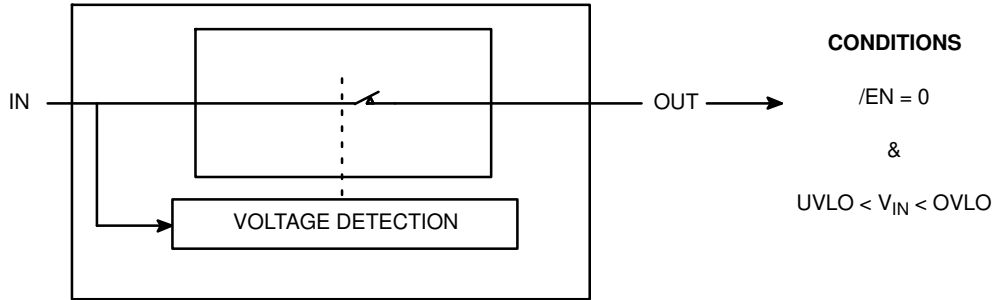

Figure 17. Simplified Diagram

## Operation

The NCP391 provides overvoltage protection for positive voltage, up to 28 V. A low  $R_{DS(on)}$  NMOSFET protects the systems (i.e.: charger) connected on the  $V_{out}$  pin, against positive overvoltage. At powerup, with  $\overline{EN}$  pin = low, the output is rising up  $t_{on}$  soft-start after the input

overtaking undervoltage UVLO (Figure 3). The NCP391 provides a  $\overline{FLAG}$  output, which alerts the system that a fault has occurred. A  $t_{start}$  additional delay, regarding available output (Figure 3) is added between output signal rising up and to  $\overline{FLAG}$  signal rising up.  $\overline{FLAG}$  pin is an open drain output.

# NCP391

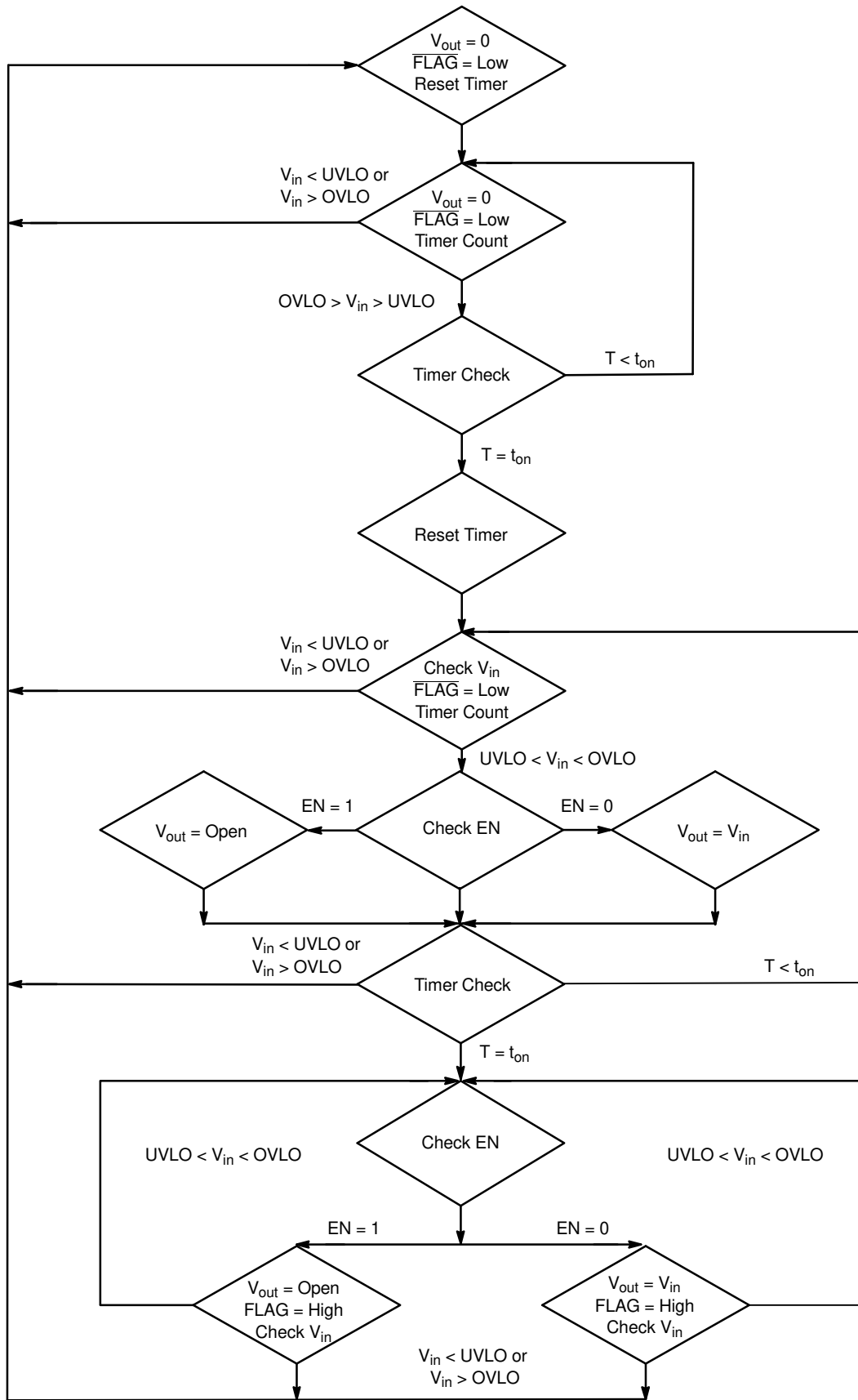

Figure 18. State Machine

**Undervoltage Lockout (UVLO)**

To ensure proper operation under any conditions, the device has a built-in undervoltage lockout (UVLO) circuit. During  $V_{in}$  positive going slope, the output remains disconnected from input until  $V_{in}$  voltage is below UVLO, plus hysteresis, nominal. The  $\overline{FLAG}$  output is tied to low as long as  $V_{in}$  does not reach UVLO threshold. This circuit has a built-in hysteresis to provide noise immunity to transient condition. Additional UVLO thresholds ranging from UVLO can be manufactured. Contact your ON Semiconductor representative for availability.

**Overvoltage Lockout (OVLO)**

To protect connected systems on  $V_{out}$  pin from overvoltage, the device has a built-in overvoltage lockout (OVLO) circuit. During overvoltage condition, the output remains disabled as long as the input voltage exceeds typical OVLO. Additional OVLO thresholds ranging from OVLO can be manufactured. Contact your ON Semiconductor representative for availability.

$\overline{FLAG}$  output is tied to low until  $V_{in}$  is higher than OVLO. This circuit has a built-in hysteresis to provide noise immunity to transient conditions.

**$\overline{FLAG}$  Output**

The NCP391 provides a  $\overline{FLAG}$  output, which alerts external systems that a fault has occurred.

This pin is tied to low as soon the OVLO threshold is exceeded or when the  $V_{in}$  level is below the UVLO threshold. When  $V_{in}$  level recovers normal condition,  $\overline{FLAG}$  is held high, keeping in mind that an additional  $t_{start}$  delay has been added between available output and  $\overline{FLAG}$  = high. The pin is an open drain output, thus a pull up resistor (typically 1 M $\Omega$ , minimum 10 k $\Omega$ ) must be added to  $V_{bat}$ . Minimum  $V_{bat}$  supply must be 2.5 V. The  $\overline{FLAG}$  level will always reflects  $V_{in}$  status, even if the device is turned off ( $\overline{EN} = 1$ ).

**$\overline{EN}$  Input**

To enable normal operation, the  $\overline{EN}$  pin shall be forced to low or connected to ground. A high level on the pin, disconnects OUT pin from IN pin.  $\overline{EN}$  does not overdrive an OVLO or UVLO fault.

**Internal NMOSFET**

The NCP391 includes an internal Low  $R_{DS(on)}$  NMOS FET to protect the systems, connected on OUT pin, from positive overvoltage. Regarding electrical characteristics, the  $R_{DS(on)}$ , during normal operation, will create low losses on  $V_{out}$  pin.

As example:  $R_{load} = 8.0 \Omega$ ,  $V_{in} = 5.0 V$   
 Typical  $R_{DS(on)} = 120 m\Omega$ ,  $I_{out} = 615 mA$   
 $V_{out} = 8 \times 0.615 = 4.926 V$

$$NMOS \text{ losses} = R_{DS(on)} \times I_{out}^2 = 0.12 \times 0.615^2 = 45 mW$$

**ESD Tests**

The NCP391 input pin fully supports the IEC61000-4-2. 1.0  $\mu F$  (minimum) must be connected between  $V_{in}$  and GND, close to the device.

That means, in Air condition,  $V_{in}$  has a  $\pm 15 kV$  ESD protected input. In Contact condition,  $V_{in}$  has  $\pm 8.0 kV$  ESD protected input.

Please refer to Figure 19 to see the IEC 61000-4-2 electrostatic discharge waveform.

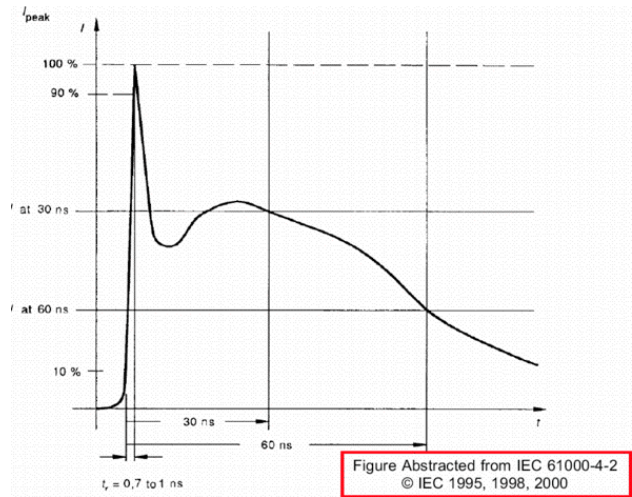

**Figure 19. Electrostatic Discharge Waveform**

**PCB Recommendations**

The NCP391 integrates a 2 A rated NMOSFET, and the PCB rules must be respected to properly evacuate the heat out of the silicon.

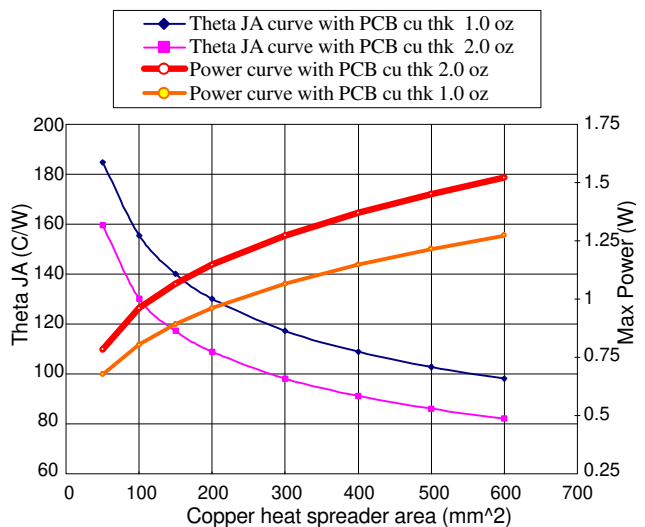

**Figure 20.**

# NCP391

## ORDERING INFORMATION

Device	Marking	Package	Shipping†
NCP391FCALT2G	391L	WLCSP6 (Pb-Free)	3000 / Tape & Reel
NCP391FCCADT2G	391D	WLCSP6 (Pb-Free)	3000 / Tape & Reel

†For information on tape and reel specifications, including part orientation and tape sizes, please refer to our Tape and Reel Packaging Specifications Brochure, BRD8011/D.

## SELECTION GUIDE

The NCP391 can be available in several undervoltage and overvoltage thresholds versions. Part number is designated as follows:

**NCP391FCxxT1G**

↑↑  
a b

Code	Contents
a	UVLO Typical Threshold a: A = 2.95 V
b	OVLO Typical Threshold b: D = 4.95 V b: L = 7.4 V

# NCP391

## PACKAGE DIMENSIONS

WLCSP6, 1.31x1.04  
CASE 499BP  
ISSUE A

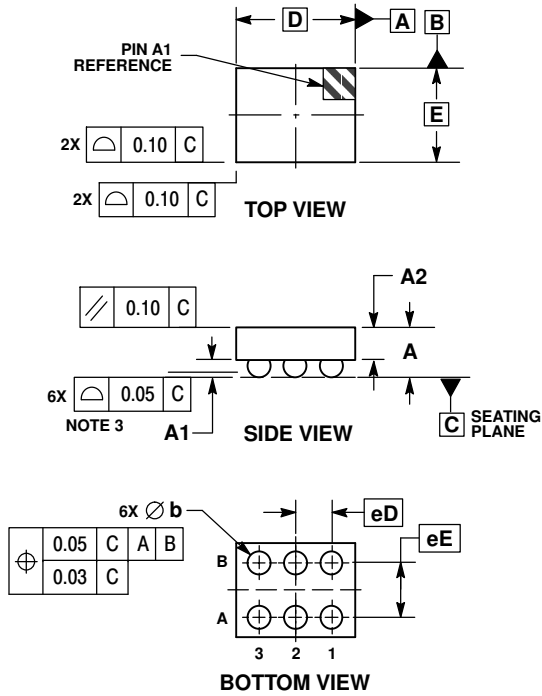

### NOTES:

1. DIMENSIONING AND TOLERANCING PER ASME Y14.5M, 1994.
2. CONTROLLING DIMENSION: MILLIMETERS.
3. COPLANARITY APPLIES TO SPHERICAL CROWNS OF SOLDER BALLS.

DIM	MILLIMETERS	
	MIN	MAX
A	0.50	0.56
A1	0.17	0.23
A2	0.33	0.39
b	0.24	0.29
D	1.31	BSC
E	1.04	BSC
eD	0.40	BSC
eE	0.60	BSC

### RECOMMENDED SOLDERING FOOTPRINT\*

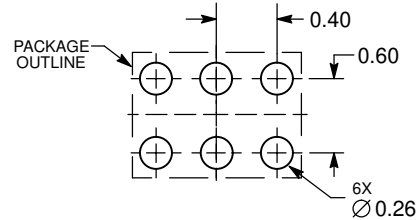

DIMENSIONS: MILLIMETERS

\*For additional information on our Pb-Free strategy and soldering details, please download the ON Semiconductor Soldering and Mounting Techniques Reference Manual, SOLDERRM/D.

# NCP391

## PACKAGE DIMENSIONS

WLCSP6, 1.31x1.04  
CASE 567JW  
ISSUE O

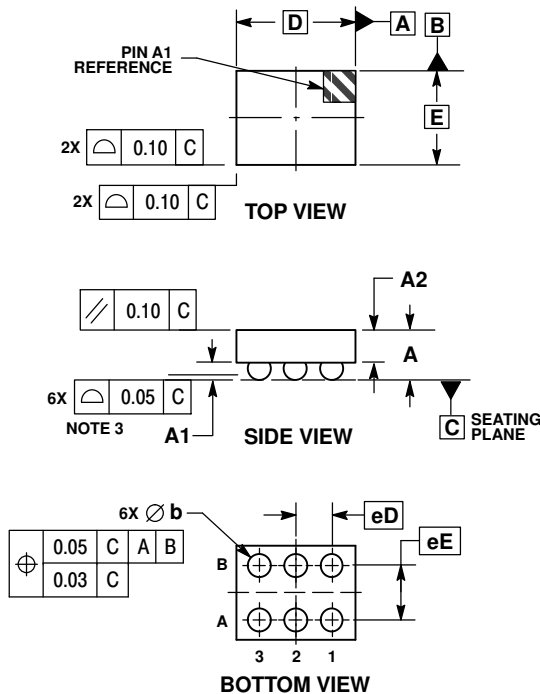

### NOTES:

1. DIMENSIONING AND TOLERANCING PER ASME Y14.5M, 1994.
2. CONTROLLING DIMENSION: MILLIMETERS.
3. COPLANARITY APPLIES TO SPHERICAL CROWNS OF SOLDER BALLS.

MILLIMETERS		
DIM	MIN	MAX
A	0.50	0.62
A1	0.17	0.23
A2	0.33	0.39
b	0.24	0.29
D	1.31 BSC	
E	1.04 BSC	
eD	0.40 BSC	
eE	0.60 BSC	

### RECOMMENDED SOLDERING FOOTPRINT\*

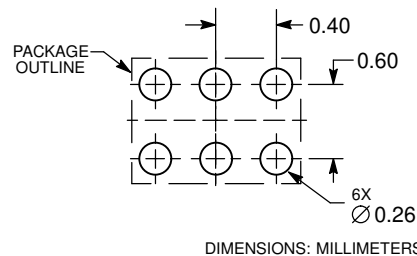

\*For additional information on our Pb-Free strategy and soldering details, please download the ON Semiconductor Soldering and Mounting Techniques Reference Manual, SOLDERM/D.

ON Semiconductor and are registered trademarks of Semiconductor Components Industries, LLC (SCILLC). SCILLC owns the rights to a number of patents, trademarks, copyrights, trade secrets, and other intellectual property. A listing of SCILLC's product/patent coverage may be accessed at [www.onsemi.com/site/pdf/Patent-Marketing.pdf](http://www.onsemi.com/site/pdf/Patent-Marketing.pdf). SCILLC reserves the right to make changes without further notice to any products herein. SCILLC makes no warranty, representation or guarantee regarding the suitability of its products for any particular purpose, nor does SCILLC assume any liability arising out of the application or use of any product or circuit, and specifically disclaims any and all liability, including without limitation special, consequential or incidental damages. "Typical" parameters which may be provided in SCILLC data sheets and/or specifications can and do vary in different applications and actual performance may vary over time. All operating parameters, including "Typicals" must be validated for each customer application by customer's technical experts. SCILLC does not convey any license under its patent rights nor the rights of others. SCILLC products are not designed, intended, or authorized for use as components in systems intended for surgical implant into the body, or other applications intended to support or sustain life, or for any other application in which the failure of the SCILLC product could create a situation where personal injury or death may occur. Should Buyer purchase or use SCILLC products for any such unintended or unauthorized application, Buyer shall indemnify and hold SCILLC and its officers, employees, subsidiaries, affiliates, and distributors harmless against all claims, costs, damages, and expenses, and reasonable attorney fees arising out of, directly or indirectly, any claim of personal injury or death associated with such unintended or unauthorized use, even if such claim alleges that SCILLC was negligent regarding the design or manufacture of the part. SCILLC is an Equal Opportunity/Affirmative Action Employer. This literature is subject to all applicable copyright laws and is not for resale in any manner.

### PUBLICATION ORDERING INFORMATION

**LITERATURE FULFILLMENT:**  
Literature Distribution Center for ON Semiconductor  
P.O. Box 5163, Denver, Colorado 80217 USA  
**Phone:** 303-675-2175 or 800-344-3860 Toll Free USA/Canada  
**Fax:** 303-675-2176 or 800-344-3867 Toll Free USA/Canada  
**Email:** [orderlit@onsemi.com](mailto:orderlit@onsemi.com)

**N. American Technical Support:** 800-282-9855 Toll Free  
USA/Canada  
**Europe, Middle East and Africa Technical Support:**  
Phone: 421 33 790 2910  
**Japan Customer Focus Center**  
Phone: 81-3-5817-1050

**ON Semiconductor Website:** [www.onsemi.com](http://www.onsemi.com)  
**Order Literature:** <http://www.onsemi.com/orderlit>

For additional information, please contact your local Sales Representative