



Chipsmall Limited consists of a professional team with an average of over 10 year of expertise in the distribution of electronic components. Based in Hongkong, we have already established firm and mutual-benefit business relationships with customers from,Europe,America and south Asia,supplying obsolete and hard-to-find components to meet their specific needs.

With the principle of “Quality Parts,Customers Priority,Honest Operation,and Considerate Service”,our business mainly focus on the distribution of electronic components. Line cards we deal with include Microchip,ALPS,ROHM,Xilinx,Pulse,ON,Everlight and Freescale. Main products comprise IC,Modules,Potentiometer,IC Socket,Relay,Connector.Our parts cover such applications as commercial,industrial, and automotives areas.

We are looking forward to setting up business relationship with you and hope to provide you with the best service and solution. Let us make a better world for our industry!



Contact us

Tel: +86-755-8981 8866 Fax: +86-755-8427 6832

Email & Skype: info@chipsmall.com Web: www.chipsmall.com

Address: A1208, Overseas Decoration Building, #122 Zhenhua RD., Futian, Shenzhen, China



NCP59302, NCV59302

3.0 A, Very Low-Dropout (VLDO) Fast Transient Response Regulator series

The NCP59302 is a high precision, very low dropout (VLDO), low ground current positive voltage regulator that is capable of providing an output current in excess of 3.0 A with a typical dropout voltage lower than 300 mV at 3.0 A load current. The device is stable with ceramic output capacitors. The device can withstand up to 18 V max input voltage.

Internal protection features consist of output current limiting, built-in thermal shutdown and reverse output current protection. Logic level enable pin is available. The NCP59302 is an adjustable voltage device and is available in D2PAK-5 package.

Features

- Output Current in Excess of 3.0 A
- 300 mV Typical Dropout Voltage at 3.0 A
- Adjustable Output Voltage Range from 1.24 V to 13 V
- Low Ground Current
- Fast Transient Response
- Stable with Ceramic Output Capacitor
- Logic Compatible Enable Pin
- Current Limit, Reverse Current and Thermal Shutdown Protection
- Operation up to 13.5 V Input Voltage
- NCV Prefix for Automotive and Other Applications Requiring Unique Site and Control Change Requirements; AEC-Q100 Qualified and PPAP Capable
- These are Pb-Free Devices

Applications

- Consumer and Industrial Equipment Point of Regulation
- Servers and Networking Equipment
- FPGA, DSP and Logic Power supplies
- Switching Power Supply Post Regulation
- Battery Chargers
- Functional Replacement for Industry Standard MIC29300, MIC39300, MIC37300



ON Semiconductor®

<http://onsemi.com>

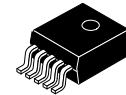

D²PAK
CASE 936A

MARKING DIAGRAMS

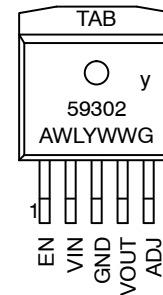

y = P (NCP), V (NCV)
A = Assembly Location
WL = Wafer Lot
Y = Year
WW = Work Week
G = Pb-Free Package

ORDERING INFORMATION

See detailed ordering and shipping information in the package dimensions section on page 9 of this data sheet.

NCP59302, NCV59302

TYPICAL APPLICATIONS

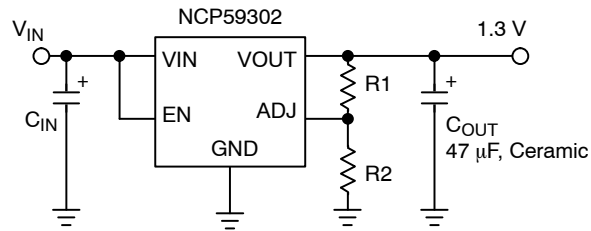

Figure 1. Adjustable Regulator

PIN FUNCTION DESCRIPTION

Pin Number	Pin Name	Pin Function
1	EN	Enable Input: CMOS and TTL logic compatible. Logic high = enable; Logic low = shutdown.
2	VIN	Input voltage which supplies both the internal circuitry and the current to the output load
3	GND	Ground
TAB	TAB	TAB is connected to ground.
4	VOU	Linear Regulator Output.
5	ADJ	Adjustable Regulator Feedback Input. Connect to output voltage resistor divider central node.

ABSOLUTE MAXIMUM RATINGS

Symbol	Rating	Value	Unit	
V_{IN}	Supply Voltage	0 to 18	V	
V_{EN}	Enable Input Voltage	0 to 18	V	
$V_{OUT} - V_{IN}$	Reverse $V_{OUT} - V_{IN}$ Voltage (EN = Shutdown or $V_{IN} = 0$ V) (Note 1)	0 to 6.5	V	
P_D	Power Dissipation (Notes 2 and 3)	Internally Limited		
T_J	Junction Temperature	$-40 \leq T_J \leq +125$	°C	
T_S	Storage Temperature	$-65 \leq T_J \leq +150$	°C	
	ESD Rating (Notes 4 and 5)	Human Body Model Machine Model	2000 200	V

Stresses exceeding Maximum Ratings may damage the device. Maximum Ratings are stress ratings only. Functional operation above the Recommended Operating Conditions is not implied. Extended exposure to stresses above the Recommended Operating Conditions may affect device reliability.

NOTE: All voltages are referenced to GND pin unless otherwise noted.

- The ENABLE pin input voltage must be ≤ 0.8 V or V_{IN} must be connected to ground potential.
- $P_{D(max)} = (T_{J(max)} - T_A) / R_{\theta JA}$, where $R_{\theta JA}$ depends upon the printed circuit board layout.
- This protection is not guaranteed outside the Recommended Operating Conditions.
- Devices are ESD sensitive. Handling precautions recommended.
- This device series incorporates ESD protection and is tested by the following methods:
ESD Human Body Model (HBM) tested per AEC-Q100-002 (EIA/JESD22-A114C)
ESD Machine Model (MM) tested per AEC-Q100-003 (EIA/JESD22-A115C)
This device contains latch-up protection and exceeds 100 mA per JEDEC Standard JESD78.

RECOMMENDED OPERATING CONDITIONS (Note 6)

Symbol	Rating	Value	Unit
V_{IN}	Supply Voltage	2.24 to 13.5	V
V_{EN}	Enable Input Voltage	0 to 13.5	V
T_J	Junction Temperature	$-40 \leq T_J \leq +125$	°C

- The device is not guaranteed to function outside its Recommended operating conditions.

NCP59302, NCV59302

ELECTRICAL CHARACTERISTICS

$T_J = 25^\circ\text{C}$ with $V_{IN} = V_{OUT\text{ nominal}} + 1\text{ V}$; $V_{EN} = V_{IN}$; $I_L = 10\text{ mA}$; bold values indicate $-40^\circ\text{C} < T_J < +125^\circ\text{C}$, unless noted.

Parameter	Conditions	Min	Typ	Max	Unit
Output Voltage Accuracy	$I_L = 10\text{ mA}$	-1		+1	%
	$10\text{ mA} < I_{OUT} < 3\text{ A}$, $V_{OUT\text{ nominal}} + 1 \leq V_{IN} \leq 13.5\text{ V}$	-2		+2	%
Output Voltage Line Regulation	$V_{IN} = V_{OUT\text{ nominal}} + 1.0\text{ V}$ to 13.5 V ; $I_L = 10\text{ mA}$		0.02	0.5	%
Output Voltage Load Regulation	$I_L = 10\text{ mA}$ to 3 A		0.2	1	%
$V_{IN} - V_{OUT}$ Dropout Voltage (Note 7)	$I_L = 1.5\text{ A}$		175	350	mV
	$I_L = 3\text{ A}$		300	500	mV
Ground Pin Current (Note 8)	$I_L = 3\text{ A}$		60	90 120	mA
Ground Pin Current in Shutdown	$V_{EN} \leq 0.5\text{ V}$		1.0	5	μA
Overload Protection Current Limit	$V_{OUT} = 0\text{ V}$ (Note 9)		3.5	5	A
Start-up Time	$V_{EN} = V_{IN}$, $V_{OUT\text{ nominal}} = 2.5\text{ V}$, $I_{OUT} = 10\text{ mA}$, $C_{OUT} = 47\text{ }\mu\text{F}$		100	500	μs

ENABLE INPUT

Enable Input Signal Levels	Regulator enable	1.8			V
	Regulator shutdown			0.8	V
Enable pin Input Current	$V_{EN} \leq 0.8\text{ V}$ (Regulator shutdown)			2 4	μA
	$6.5\text{ V} > V_{EN} \geq 1.8\text{ V}$ (Regulator enable)	1	15	30 40	μA
Reference Voltage		1.228 1.215	1.240	1.252 1.265	V
Adjust Pin Bias Current			100	200 350	nA

7. $V_{DO} = V_{IN} - V_{OUT}$ when V_{OUT} decreases to 98% of its nominal output voltage with $V_{IN} = V_{OUT} + 1\text{ V}$. For output voltages below 1.74 V, dropout voltage specification does not apply due to a minimum input operating voltage of 2.24 V.

8. $I_{IN} = I_{GND} + I_{OUT}$.

9. Device Power-on or Enable Start-up with output shorted to GND.

Package	Conditions / PCB Footprint	Thermal Resistance
D2PAK-5, Junction-to-Case		$R_{\theta JC} = 2.1^\circ\text{C/W}$
D2PAK-5, Junction-to-Air	PCB with 100 mm ² 2.0 oz Copper Heat Spreading Area	$R_{\theta JA} = 52^\circ\text{C/W}$

NCP59302, NCV59302

TYPICAL CHARACTERISTICS

$T_J = 25^\circ\text{C}$ if not otherwise noted

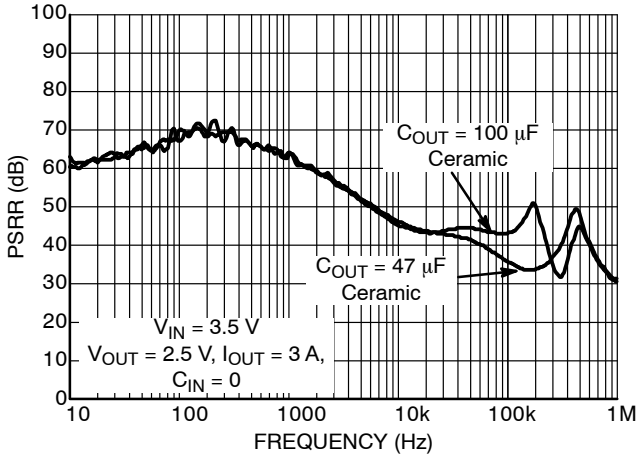

Figure 2. Power Supply Rejection Ratio

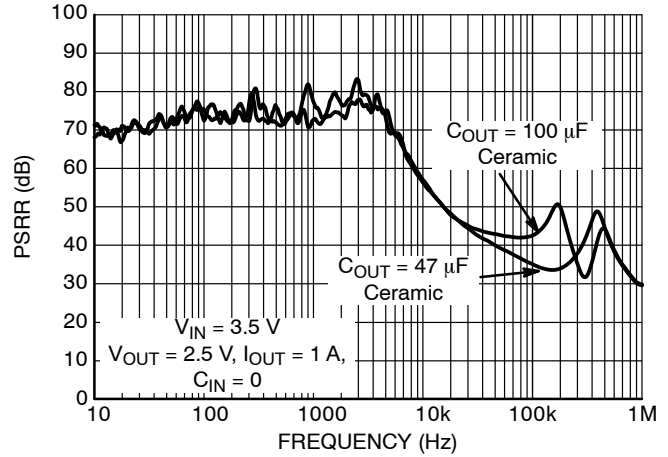

Figure 3. Power Supply Rejection Ratio

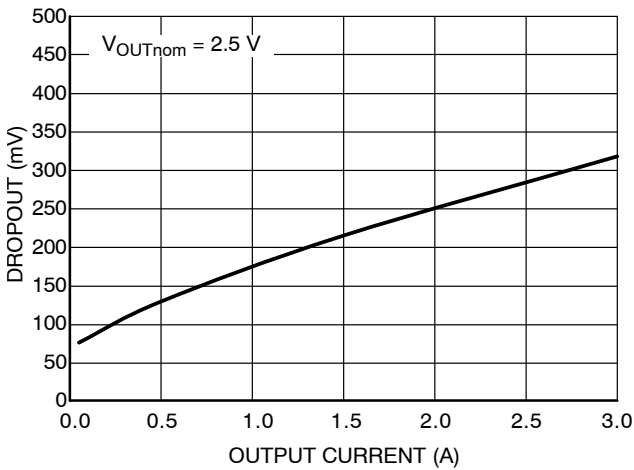

Figure 4. Dropout Voltage vs. Output Current

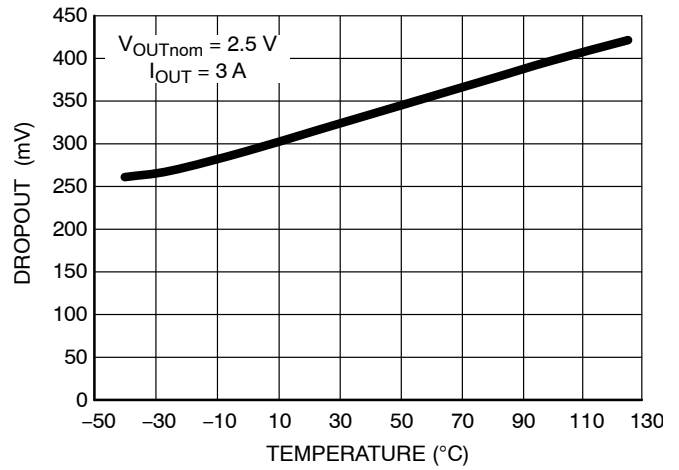

Figure 5. Dropout Voltage vs. Temperature

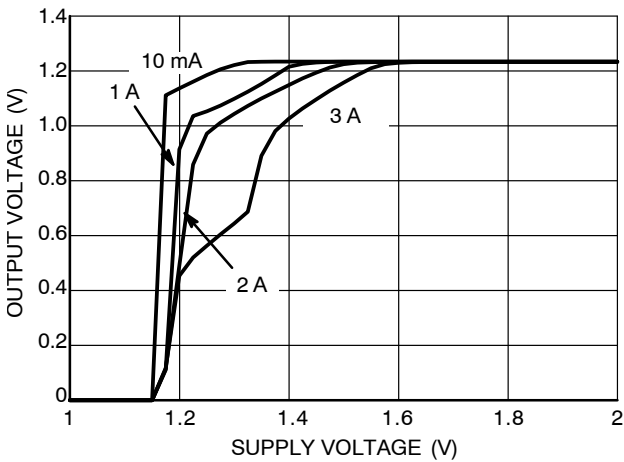

Figure 6. Dropout Characteristics (1.24 V)

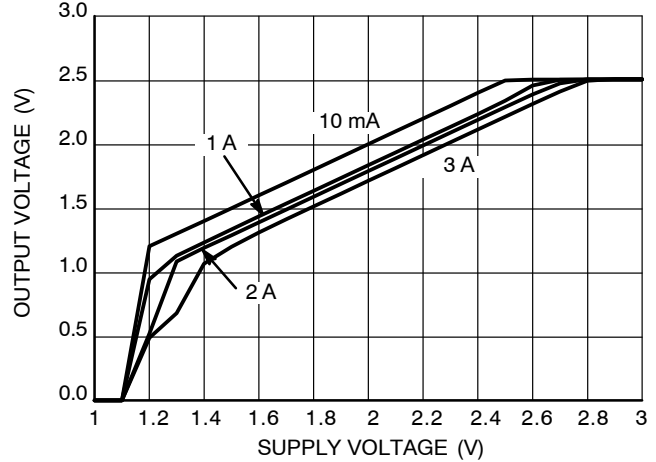

Figure 7. Dropout Characteristics (2.5 V)

NCP59302, NCV59302

TYPICAL CHARACTERISTICS

$T_J = 25^\circ\text{C}$ if not otherwise noted

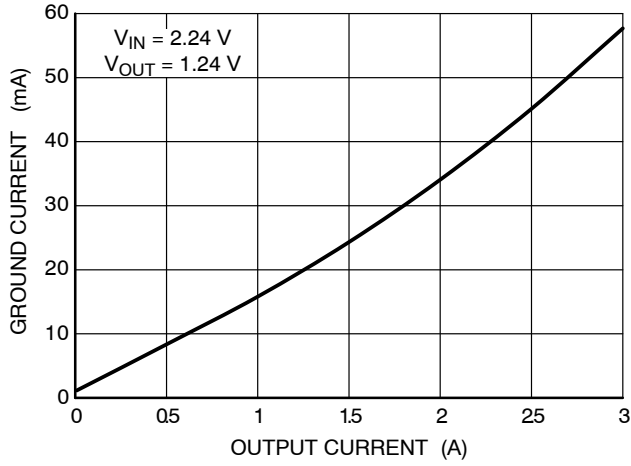

Figure 8. Ground Current vs. Output Current

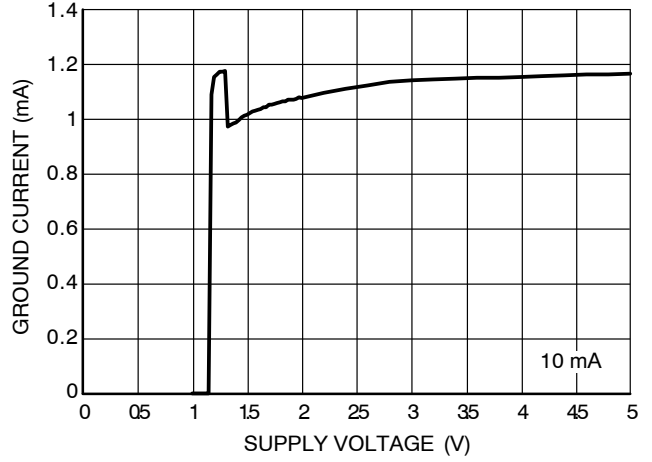

Figure 9. Ground Current vs. Supply Voltage (1.24 V)

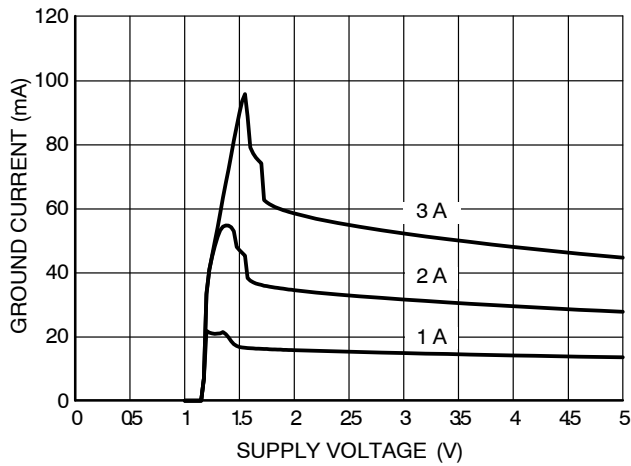

Figure 10. Ground Current vs. Supply Voltage (1.24 V)

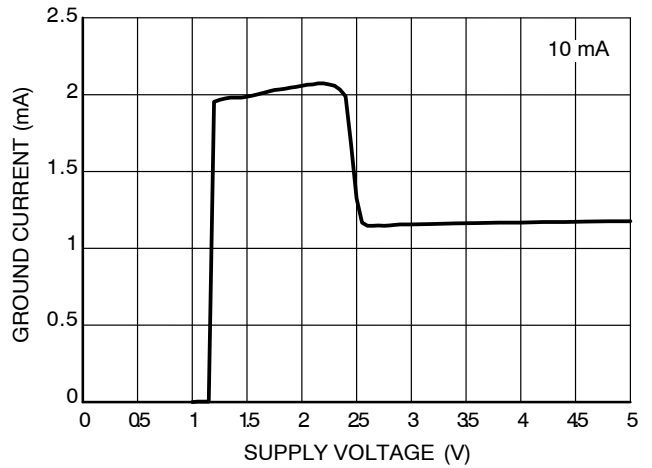

Figure 11. Ground Current vs. Supply Voltage (2.5 V)

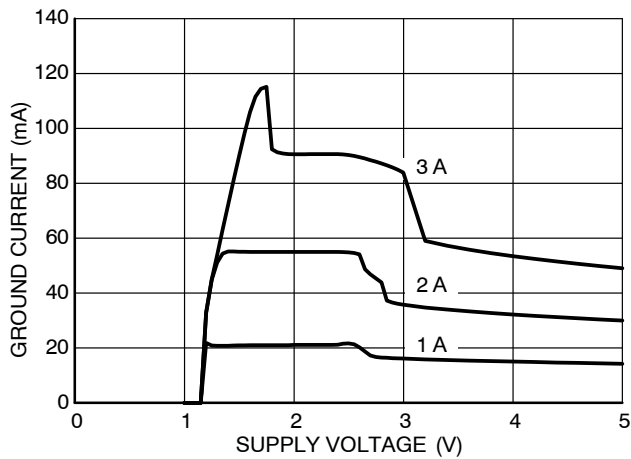

Figure 12. Ground Current vs. Supply Voltage (2.5 V)

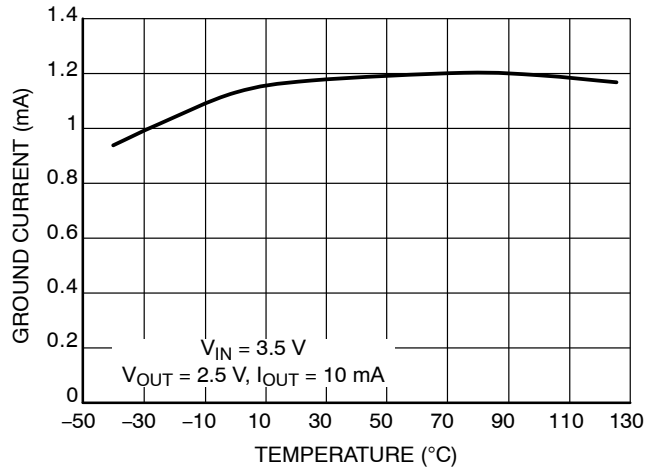

Figure 13. Ground Current vs. Temperature

NCP59302, NCV59302

TYPICAL CHARACTERISTICS

$T_J = 25^\circ\text{C}$ if not otherwise noted

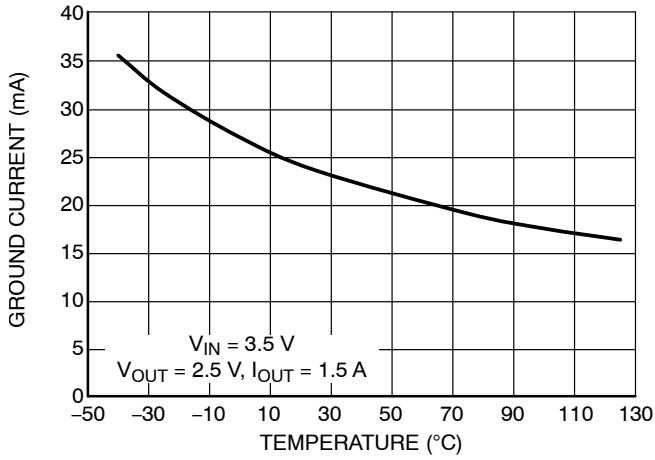

Figure 14. Ground Current vs. Temperature

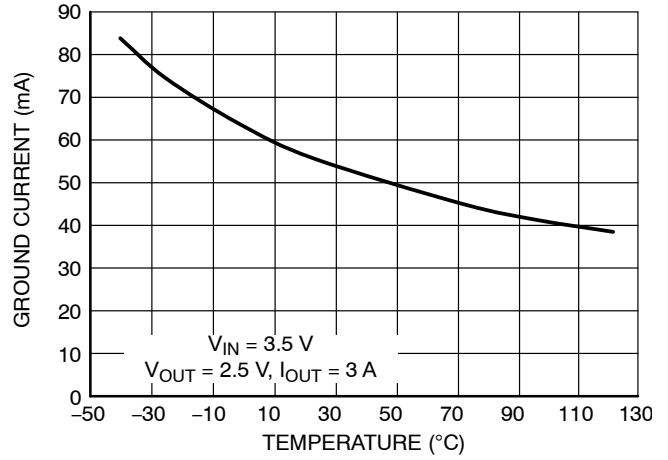

Figure 15. Ground Current vs. Temperature

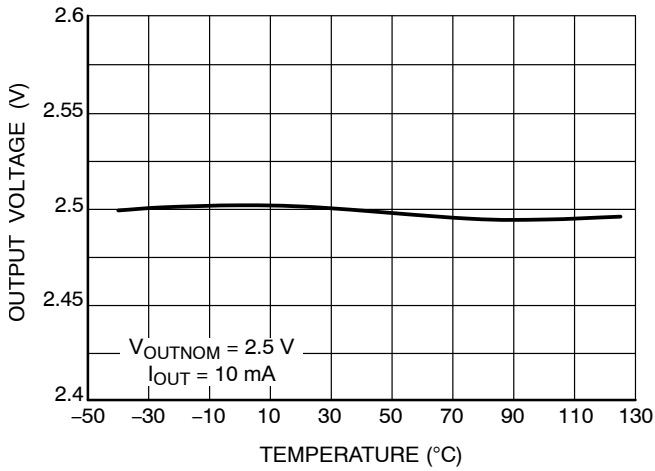

Figure 16. Output Voltage vs. Temperature

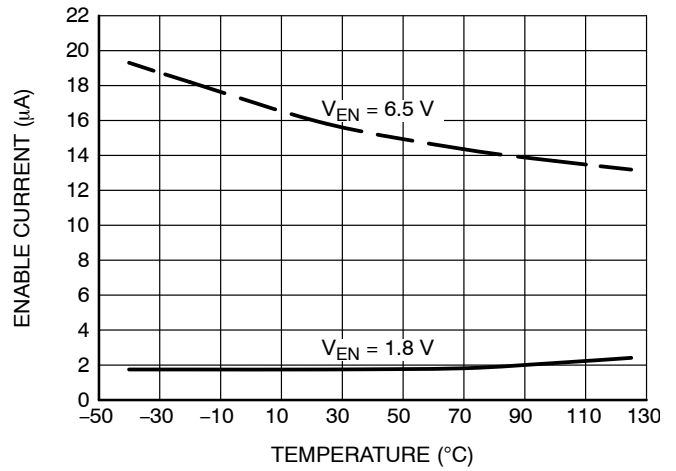

Figure 17. Enable Pin Input Current vs. Temperature

NCP59302, NCV59302

FUNCTIONAL CHARACTERISTICS

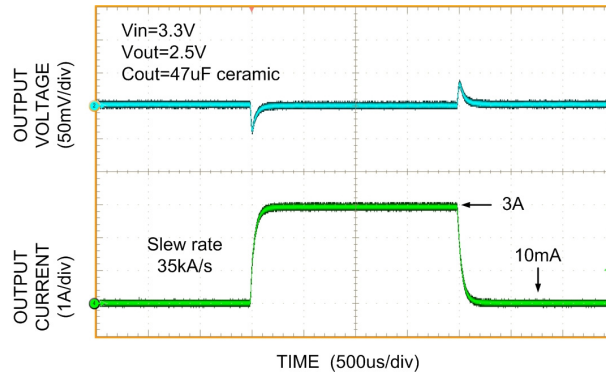

Figure 18. Load Transient Response

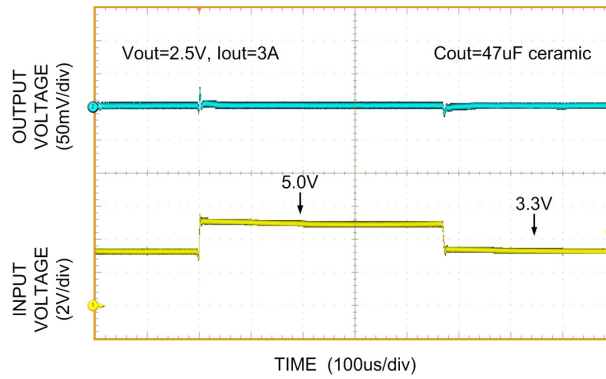

Figure 19. Line Transient Response

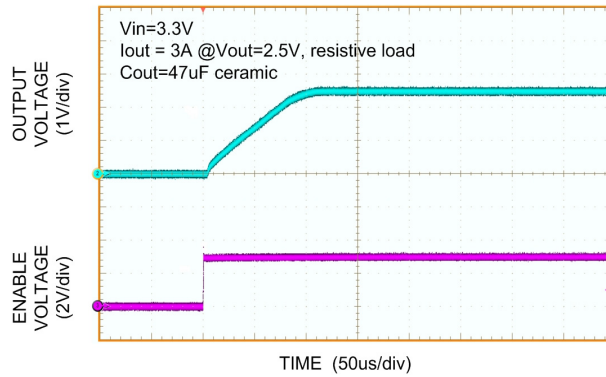

Figure 20. Enable Transient Response

APPLICATIONS INFORMATION

Output Capacitor and Stability

The NCP59302 device requires an output capacitor for stable operation. The NCP59302 is designed to operate with ceramic output capacitors. The recommended output capacitance value is 47 μF or greater. Such capacitors help to improve transient response and noise reduction at high frequency.

Input Capacitor

An input capacitor of 1.0 μF or greater is recommended when the device is more than 4 inches away from the bulk supply capacitance, or when the supply is a battery. Small, surface-mount chip capacitors can be used for the bypassing. The capacitor should be placed within 1 inch of the device for optimal performance. Larger values will help to improve ripple rejection by bypassing the input of the regulator, further improving the integrity of the output voltage.

Minimum Load Current

The NCP59302 regulator is specified between finite loads. A 10 mA minimum load current is necessary for proper operation.

Enable Input

NCP59302 regulators also feature an enable input for on/off control of the device. It's shutdown state draws “zero” current from input voltage supply (only microamperes of leakage). The enable input is TTL/CMOS compatible for simple logic interface, but can be connected up to V_{IN}.

Overcurrent and Reverse Output Current Protection

The NCP59302 regulator is fully protected from damage due to output current overload conditions. When NCP59302 output is overloaded, Output Current limiting is provided. This limiting is linear; output current during overload conditions is constant. The device is also capable to withstand power-on or enable start-up with output shorted to ground for the full Recommended Operating Conditions range. These features are advantageous for powering FPGAs and other ICs having current consumption higher than nominal during their startup.

Thermal shutdown disables the NCP59302 device when the die temperature exceeds the maximum safe operating temperature.

When NCP59302 is disabled and (V_{OUT} – V_{IN}) voltage difference is less than 6.5 V in the application, the output structure of these regulators is able to withstand output voltage (backup battery as example) to be applied without reverse current flow.

Adjustable Voltage Design

The NCP/NCV59302 Adjustable voltage Device Output voltage is set by the ratio of two external resistors as shown in Figure 21.

The device maintains the voltage at the ADJ pin at 1.24 V referenced to ground. The current in R2 is then equal to 1.24 V / R2, and the current in R1 is the current in R2 plus the ADJ pin bias current. The ADJ pin bias current flows from V_{OUT} through R1 into the ADJ pin.

The output voltage can be calculated using the formula shown in Figure 21.

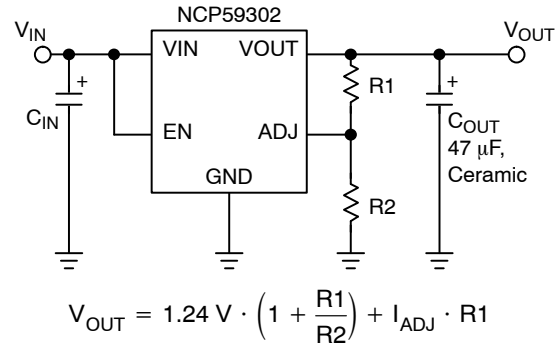

Figure 21. Adjustable Voltage Operation

Thermal Considerations

The power handling capability of the device is limited by the maximum rated junction temperature (125°C). The P_D total power dissipated by the device has two components, Input to output voltage differential multiplied by Output current and Input voltage multiplied by GND pin current.

$$P_D = (V_{IN} - V_{OUT}) \cdot I_{OUT} + V_{IN} \cdot I_{GND} \quad (\text{eq. 1})$$

The GND pin current value can be found in Electrical Characteristics table and in Typical Characteristics graphs. The Junction temperature T_J is

$$T_J = T_A + P_D \cdot R_{\theta JA} \quad (\text{eq. 2})$$

where T_A is ambient temperature and R_{θJA} is the Junction to Ambient Thermal Resistance of the NCP/NCV59302 device mounted on the specific PCB.

To maximize efficiency of the application and minimize thermal power dissipation of the device it is convenient to use the Input to output voltage differential as low as possible.

The static typical dropout characteristics for various output voltage and output current can be found in the Typical Characteristics graphs.

NCP59302, NCV59302

ORDERING INFORMATION

Device	Output Current	Output Voltage	Junction Temp. Range	Package	Shipping [†]
NCP59302DSADJR4G	3.0 A	ADJ	-40°C to +125°C	D2PAK-5 (Pb-Free)	800 / Tape & Reel
NCV59302DSADJR4G*	3.0 A	ADJ	-40°C to +125°C	D2PAK-5 (Pb-Free)	800 / Tape & Reel

[†]For information on tape and reel specifications, including part orientation and tape sizes, please refer to our Tape and Reel Packaging Specifications Brochure, BRD8011/D.

*NCV Prefix for Automotive and Other Applications Requiring Unique Site and Control Change Requirements; AEC-Q100 Qualified and PPAP Capable.

NCP59302, NCV59302

PACKAGE DIMENSIONS

D²PAK 5 CASE 936A-02 ISSUE C

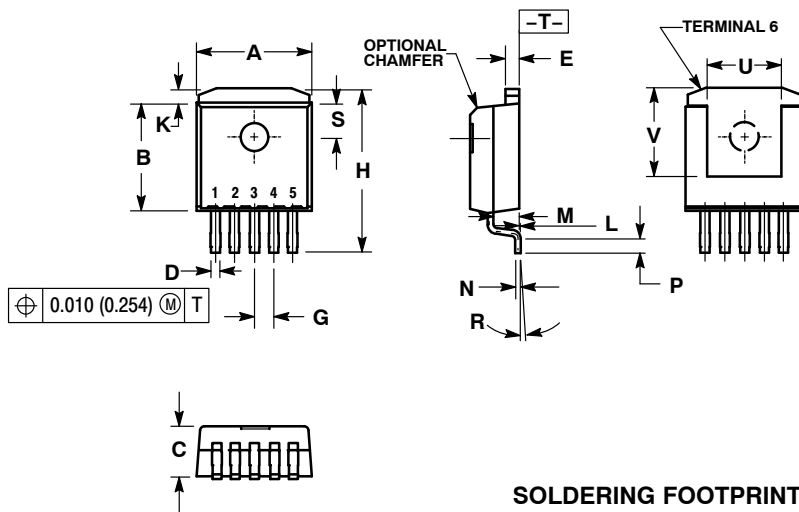

NOTES:

1. DIMENSIONING AND TOLERANCING PER ANSI Y14.5M, 1982.
2. CONTROLLING DIMENSION: INCH.
3. TAB CONTOUR OPTIONAL WITHIN DIMENSIONS A AND K.
4. DIMENSIONS U AND V ESTABLISH A MINIMUM MOUNTING SURFACE FOR TERMINAL 6.
5. DIMENSIONS A AND B DO NOT INCLUDE MOLD FLASH OR GATE PROTRUSIONS. MOLD FLASH AND GATE PROTRUSIONS NOT TO EXCEED 0.025 (0.635) MAXIMUM.

DIM	INCHES		MILLIMETERS	
	MIN	MAX	MIN	MAX
A	0.386	0.403	9.804	10.236
B	0.356	0.368	9.042	9.347
C	0.170	0.180	4.318	4.572
D	0.026	0.036	0.660	0.914
E	0.045	0.055	1.143	1.397
G	0.067 BSC		1.702 BSC	
H	0.539	0.579	13.691	14.707
K	0.050 REF		1.270 REF	
L	0.000	0.010	0.000	0.254
M	0.088	0.102	2.235	2.591
N	0.018	0.026	0.457	0.660
P	0.058	0.078	1.473	1.981
R	5° REF		5° REF	
S	0.116 REF		2.946 REF	
U	0.200 MIN		5.080 MIN	
V	0.250 MIN		6.350 MIN	

SOLDERING FOOTPRINT

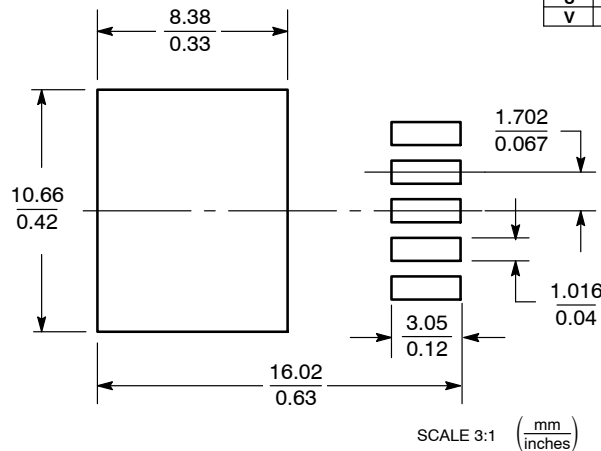

5-LEAD D²PAK

ON Semiconductor and are registered trademarks of Semiconductor Components Industries, LLC (SCILLC). SCILLC owns the rights to a number of patents, trademarks, copyrights, trade secrets, and other intellectual property. A listing of SCILLC's product/patent coverage may be accessed at www.onsemi.com/site/pdf/Patent-Marking.pdf. SCILLC reserves the right to make changes without further notice to any products herein. SCILLC makes no warranty, representation or guarantee regarding the suitability of its products for any particular purpose, nor does SCILLC assume any liability arising out of the application or use of any product or circuit, and specifically disclaims any and all liability, including without limitation special, consequential or incidental damages. "Typical" parameters which may be provided in SCILLC data sheets and/or specifications can and do vary in different applications and actual performance may vary over time. All operating parameters, including "Typicals" must be validated for each customer application by customer's technical experts. SCILLC does not convey any license under its patent rights nor the rights of others. SCILLC products are not designed, intended, or authorized for use as components in systems intended for surgical implant into the body, or other applications intended to support or sustain life, or for any other application in which the failure of the SCILLC product could create a situation where personal injury or death may occur. Should Buyer purchase or use SCILLC products for any such unintended or unauthorized application, Buyer shall indemnify and hold SCILLC and its officers, employees, subsidiaries, affiliates, and distributors harmless against all claims, costs, damages, and expenses, and reasonable attorney fees arising out of, directly or indirectly, any claim of personal injury or death associated with such unintended or unauthorized use, even if such claim alleges that SCILLC was negligent regarding the design or manufacture of the part. SCILLC is an Equal Opportunity/Affirmative Action Employer. This literature is subject to all applicable copyright laws and is not for resale in any manner.

PUBLICATION ORDERING INFORMATION

LITERATURE FULFILLMENT:

Literature Distribution Center for ON Semiconductor
P.O. Box 5163, Denver, Colorado 80217 USA
Phone: 303-675-2175 or 800-344-3860 Toll Free USA/Canada
Fax: 303-675-2176 or 800-344-3867 Toll Free USA/Canada
Email: orderlit@onsemi.com

N. American Technical Support: 800-282-9855 Toll Free
USA/Canada
Europe, Middle East and Africa Technical Support:
Phone: 421 33 790 2910
Japan Customer Focus Center
Phone: 81-3-5817-1050

ON Semiconductor Website: www.onsemi.com

Order Literature: <http://www.onsemi.com/orderlit>

For additional information, please contact your local Sales Representative