



Chipsmall Limited consists of a professional team with an average of over 10 year of expertise in the distribution of electronic components. Based in Hongkong, we have already established firm and mutual-benefit business relationships with customers from,Europe,America and south Asia,supplying obsolete and hard-to-find components to meet their specific needs.

With the principle of "Quality Parts,Customers Priority,Honest Operation,and Considerate Service",our business mainly focus on the distribution of electronic components. Line cards we deal with include Microchip,ALPS,ROHM,Xilinx,Pulse,ON,Everlight and Freescale. Main products comprise IC,Modules,Potentiometer,IC Socket,Relay,Connector.Our parts cover such applications as commercial,industrial, and automotives areas.

We are looking forward to setting up business relationship with you and hope to provide you with the best service and solution. Let us make a better world for our industry!



## Contact us

Tel: +86-755-8981 8866 Fax: +86-755-8427 6832

Email & Skype: info@chipsmall.com Web: www.chipsmall.com

Address: A1208, Overseas Decoration Building, #122 Zhenhua RD., Futian, Shenzhen, China



# NCP717

## 300 mA, Very-Low Quiescent Current, $I_Q$ 25 $\mu$ A, Low Noise, Low Dropout Regulator

The NCP717 is 300 mA LDO that provides the engineer with a very stable, accurate voltage with very low noise suitable for space constrained, noise sensitive applications. In order to optimize performance for battery operated portable applications, the NCP717 employs the dynamic quiescent current adjustment for very low  $I_Q$  consumption at no-load.

### Features

- Operating Input Voltage Range: 1.8 V to 5.5 V
- Available in Fixed Voltage Options: 0.8 V to 5 V  
Contact Factory for Other Voltage Options
- Very Low Quiescent Current of Typ. 25  $\mu$ A
- Very Low Noise: 22  $\mu$ V<sub>RMS</sub> from 100 Hz to 100 kHz
- Low Dropout: 175 mV Typical at 300 mA
- $\pm 2\%$  Accuracy Over Load/Line/Temperature
- High Power Supply Ripple Rejection: 70 dB at 1 kHz
- Thermal Shutdown and Current Limit Protections
- Stable with a 1  $\mu$ F Ceramic Output Capacitor
- Available in XDFN 1.0 x 1.0 mm Package
- These are Pb-Free Devices

### Typical Applications

- PDAs, Mobile phones, GPS, Smartphones
- Wireless Handsets, Wireless LAN, Bluetooth®, Zigbee®
- Portable Medical Equipment
- Other Battery Powered Applications

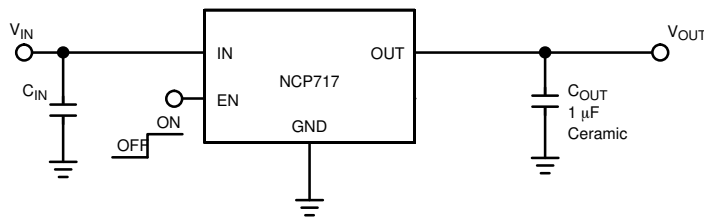


Figure 1. Typical Application Schematic



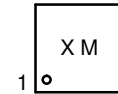
ON Semiconductor®

[www.onsemi.com](http://www.onsemi.com)



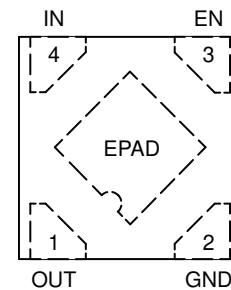
XDFN4  
MX SUFFIX  
CASE 711AJ

### MARKING DIAGRAM



X = Specific Device Code  
M = Date Code

### PIN CONNECTION

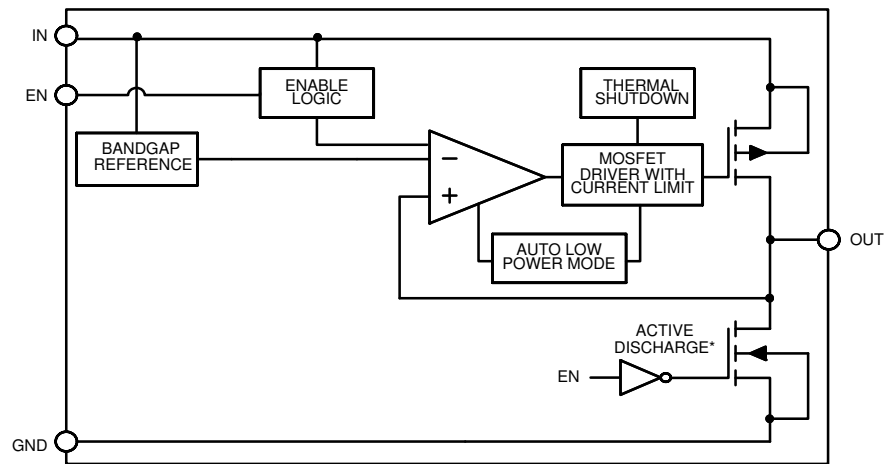


(Top View)

### ORDERING INFORMATION

See detailed ordering and shipping information in the package dimensions section on page 15 of this data sheet.

# NCP717



\*Active output discharge function is present only in NCP717AMXyyyTCG and NCP717CMXyyyTCG devices. yyy denotes the particular  $V_{OUT}$  option.

**Figure 2. Simplified Schematic Block Diagram**

## PIN FUNCTION DESCRIPTION

Pin No.	Pin Name	Description
1	OUT	Regulated output voltage pin. A small ceramic capacitor with minimum value of 1 $\mu\text{F}$ is needed from this pin to ground to assure stability.
2	GND	Power supply ground.
3	EN	Driving EN over 0.9 V turns on the regulator. Driving EN below 0.4 V puts the regulator into shutdown mode.
4	IN	Input pin. A small capacitor is needed from this pin to ground to assure stability.
-	EPAD	Exposed pad should be connected directly to the GND pin. Soldered to a large ground copper plane allows for effective heat removal.

## ABSOLUTE MAXIMUM RATINGS

Rating	Symbol	Value	Unit
Input Voltage (Note 1)	$V_{IN}$	-0.3 V to 6 V	V
Output Voltage	$V_{OUT}$	-0.3 V to $V_{IN} + 0.3$ V	V
Enable Input	$V_{EN}$	-0.3 V to $V_{IN} + 0.3$ V	V
Output Short Circuit Duration	tSC	$\infty$	s
Maximum Junction Temperature	$T_{J(MAX)}$	150	$^{\circ}\text{C}$
Storage Temperature	$T_{STG}$	-55 to 150	$^{\circ}\text{C}$
ESD Capability, Human Body Model (Note 2)	$ESD_{HBM}$	2000	V
ESD Capability, Machine Model (Note 2)	$ESD_{MM}$	200	V

Stresses exceeding those listed in the Maximum Ratings table may damage the device. If any of these limits are exceeded, device functionality should not be assumed, damage may occur and reliability may be affected.

1. Refer to ELECTRICAL CHARACTERISTICS and APPLICATION INFORMATION for Safe Operating Area.

2. This device series incorporates ESD protection and is tested by the following methods:

ESD Human Body Model tested per EIA/JESD22-A114,

ESD Machine Model tested per EIA/JESD22-A115,

Latchup Current Maximum Rating tested per JEDEC standard: JESD78.

## THERMAL CHARACTERISTICS

Rating	Symbol	Value	Unit
Thermal Characteristics, XDFN4 1x1 mm Thermal Resistance, Junction-to-Air	$R_{\theta JA}$	250	$^{\circ}\text{C}/\text{W}$



# NCP717

## ELECTRICAL CHARACTERISTICS

$-40^{\circ}\text{C} \leq T_J \leq 125^{\circ}\text{C}$ ;  $V_{IN} = V_{OUT(NOM)} + 0.5\text{ V}$  or  $2.3\text{ V}$ , whichever is greater;  $I_{OUT} = 10\text{ mA}$ ,  $C_{IN} = C_{OUT} = 1\text{ }\mu\text{F}$ , unless otherwise noted.  $V_{EN} = 0.9\text{ V}$ . Typical values are at  $T_J = +25^{\circ}\text{C}$ . Min./Max. are for  $T_J = -40^{\circ}\text{C}$  and  $T_J = +125^{\circ}\text{C}$  respectively (Note 3).

Parameter	Test Conditions		Symbol	Min	Typ	Max	Unit
Operating Input Voltage			$V_{IN}$	1.8		5.5	V
Output Voltage Accuracy	$2.3\text{ V} \leq V_{IN} \leq 4.2\text{ V}$ $I_{OUT} = 0 - 300\text{ mA}$	$V_{OUT(nom)} < 1.5\text{ V}$	$V_{OUT}$	-30		+30	mV
	$V_{OUT(NOM)} + 0.5\text{ V}$ or $2.3\text{ V} \leq V_{IN} \leq 5.5\text{ V}$ $I_{OUT} = 0 - 300\text{ mA}$	$V_{OUT(nom)} \geq 1.5\text{ V}$		-2		+2	%
Line Regulation	$V_{OUT} + 0.5\text{ V}$ or $2.3\text{ V} \leq V_{IN} \leq 5.5\text{ V}$ , $I_{OUT} = 10\text{ mA}$		Reg <sub>LINE</sub>		400		$\mu\text{V/V}$
Load Regulation	$I_{OUT} = 0\text{ mA}$ to $300\text{ mA}$		Reg <sub>LOAD</sub>		12		$\mu\text{V/mA}$
Load Transient	$I_{OUT} = 1\text{ mA}$ to $300\text{ mA}$ or $300\text{ mA}$ to $1\text{ mA}$ in $1\text{ }\mu\text{s}$ , $C_{OUT} = 1\text{ }\mu\text{F}$		Tran <sub>LOAD</sub>		95		mV
Dropout Voltage (Note 4)	$I_{OUT} = 300\text{ mA}$	$V_{OUT} = 2.5\text{ V}$	$V_{DO}$		190	350	mV
		$V_{OUT} = 2.8\text{ V}$			175	280	
		$V_{OUT} = 2.85\text{ V}$			175	265	
		$V_{OUT} = 3.0\text{ V}$			170	250	
		$V_{OUT} = 3.1\text{ V}$			165	235	
		$V_{OUT} = 3.2\text{ V}$			165	235	
		$V_{OUT} = 3.3\text{ V}$			155	230	
Output Current Limit	$V_{OUT} = 90\% V_{OUT(nom)}$		$I_{CL}$		379	500	mA
Ground Current	$I_{OUT} = 0\text{ mA}$		$I_Q$		25	35	$\mu\text{A}$
	$I_{OUT} = 2\text{ mA}$		$I_{GND}$		105		
	$I_{OUT} = 300\text{ mA}$		$I_{GND}$		250		
Shutdown Current	$V_{EN} \leq 0.4\text{ V}$ , $V_{IN} = 5.5\text{ V}$		$I_{DIS}$		0.01	1	$\mu\text{A}$
EN Pin Threshold Voltage High Threshold Low Threshold	$V_{EN}$ Voltage increasing $V_{EN}$ Voltage decreasing		$V_{EN\_HI}$ $V_{EN\_LO}$	0.9		0.4	V
EN Pin Input Current	$V_{EN} = 5.5\text{ V}$		$I_{EN}$		180	500	nA
Turn-on Time	$C_{OUT} = 1.0\text{ }\mu\text{F}$ , From assertion of $V_{EN}$ to 98% $V_{OUT(NOM)}$		$t_{ON}$		200		$\mu\text{s}$
Power Supply Rejection Ratio	$V_{IN} = 3.6\text{ V}$ , $V_{OUT} = 3.1\text{ V}$ $I_{OUT} = 150\text{ mA}$	$f = 100\text{ Hz}$ $f = 1\text{ kHz}$ $f = 10\text{ kHz}$	PSRR		58 70 55		dB
Output Noise Voltage	$V_{IN} = 3.6\text{ V}$ , $V_{OUT} = 3.1\text{ V}$ , $I_{OUT} = 300\text{ mA}$ $f = 100\text{ Hz}$ to $100\text{ kHz}$		$V_N$		22		$\mu\text{V}_{rms}$
Thermal Shutdown Temperature	Temperature increasing from $T_J = +25^{\circ}\text{C}$		$T_{SD}$		160		$^{\circ}\text{C}$
Thermal Shutdown Hysteresis	Temperature falling from $T_{SD}$		$T_{SDH}$		20		$^{\circ}\text{C}$
Active Output Discharge Resistance	$V_{EN} < 0.4\text{ V}$	Version A	$R_{DIS}$		1.2		$\text{k}\Omega$
		Version C			120		$\Omega$

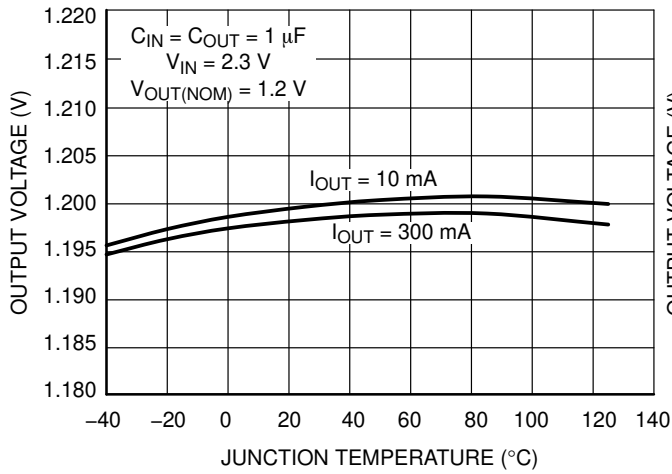
Product parametric performance is indicated in the Electrical Characteristics for the listed test conditions, unless otherwise noted. Product performance may not be indicated by the Electrical Characteristics if operated under different conditions.

3. Performance guaranteed over the indicated operating temperature range by design and/or characterization. Production tested at

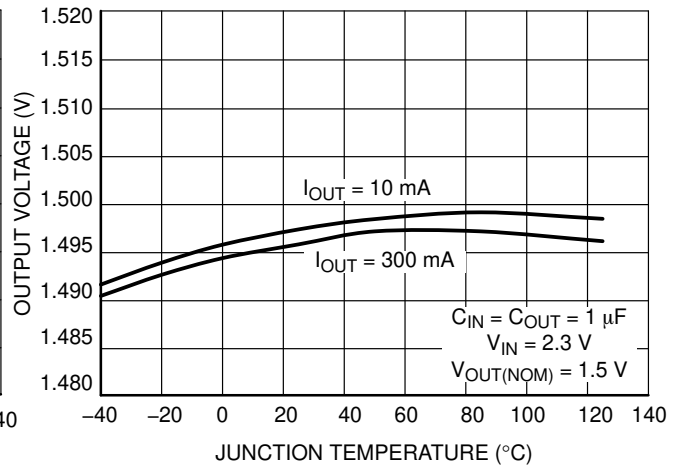
$T_J = T_A = 25^{\circ}\text{C}$ . Low duty cycle pulse techniques are used during testing to maintain the junction temperature as close to ambient as possible.

4. Characterized when  $V_{OUT}$  falls 100 mV below the regulated voltage at  $V_{IN} = V_{OUT(NOM)} + 0.5\text{ V}$ .

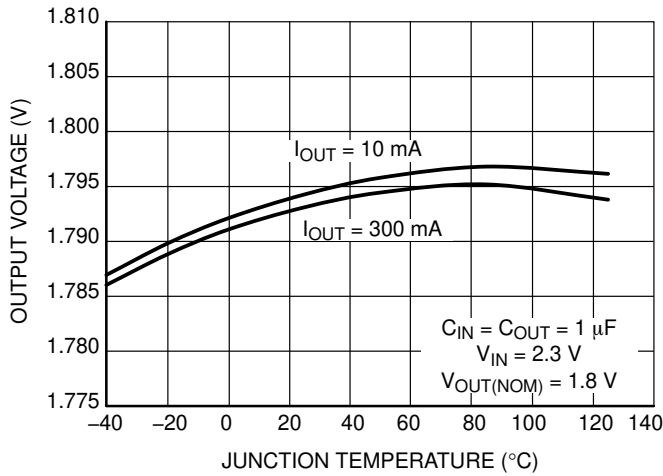
# NCP717



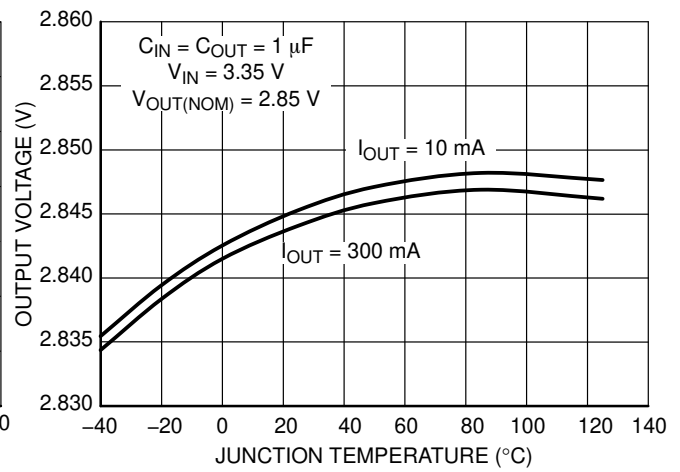
**Figure 1. Output Voltage vs. Temperature**  
 $V_{OUT} = 1.2\text{ V}$



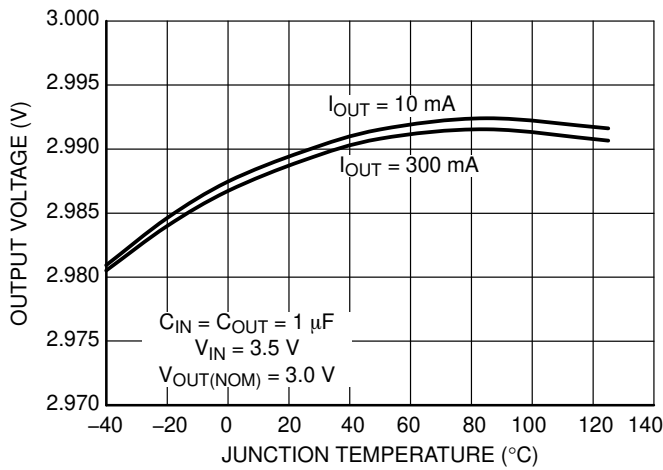
**Figure 1. Output Voltage vs. Temperature**  
 $V_{OUT} = 1.5\text{ V}$



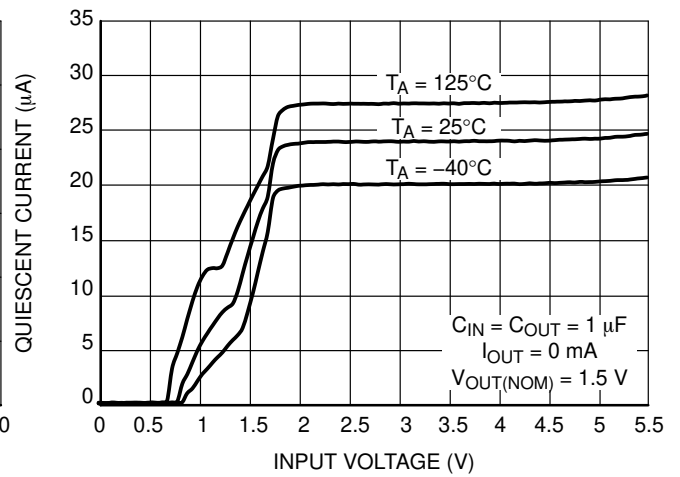
**Figure 2. Output Voltage vs. Temperature**  
 $V_{OUT} = 1.85\text{ V}$



**Figure 3. Output Voltage vs. Temperature**  
 $V_{OUT} = 2.85\text{ V}$



**Figure 4. Output Voltage vs. Temperature**  
 $V_{OUT} = 3.0\text{ V}$



**Figure 5. Quiescent Current vs. Temperature**  
 $V_{OUT} = 1.5\text{ V}$

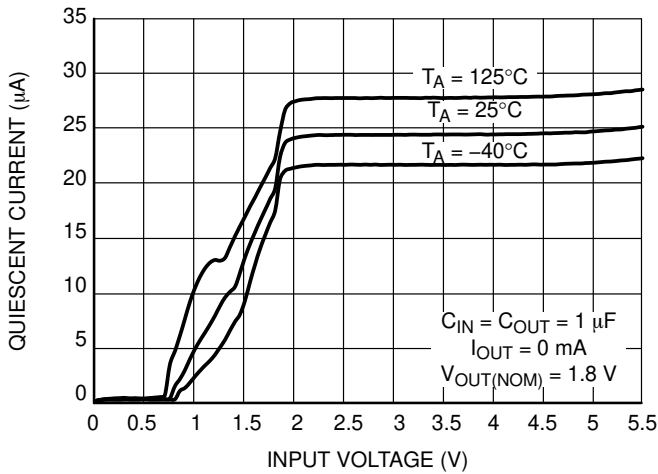


Figure 6. Quiescent Current vs. Temperature  
 $V_{OUT} = 1.8 \text{ V}$

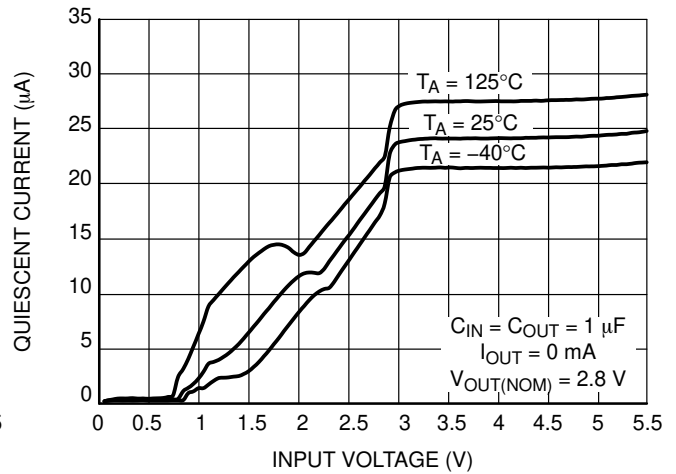


Figure 7. Quiescent Current vs. Temperature  
 $V_{OUT} = 2.8 \text{ V}$

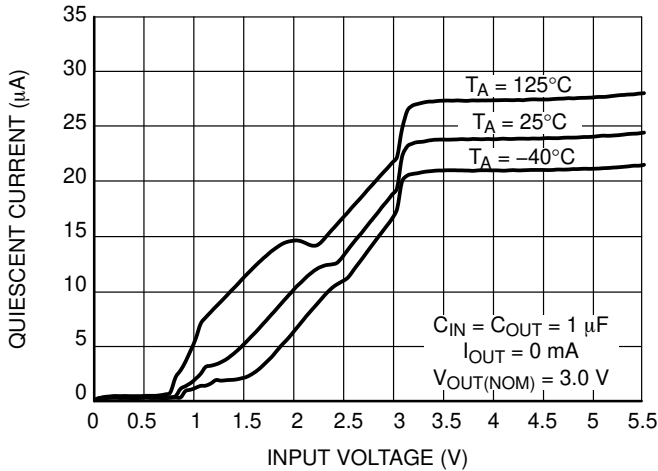


Figure 8. Quiescent Current vs. Temperature  
 $V_{OUT} = 3.0 \text{ V}$

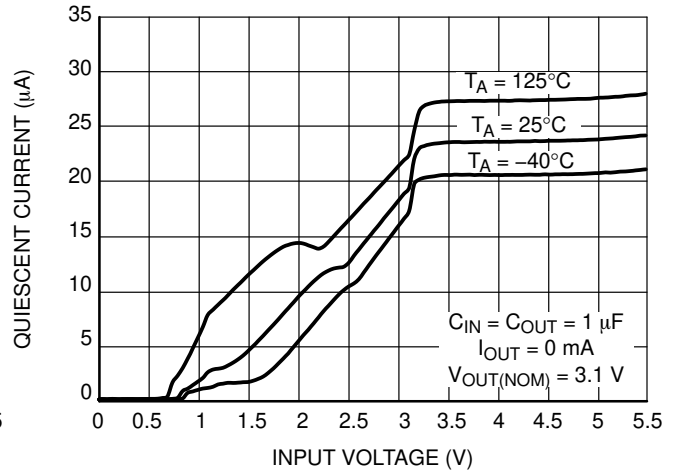


Figure 9. Quiescent Current vs. Temperature  
 $V_{OUT} = 3.1 \text{ V}$

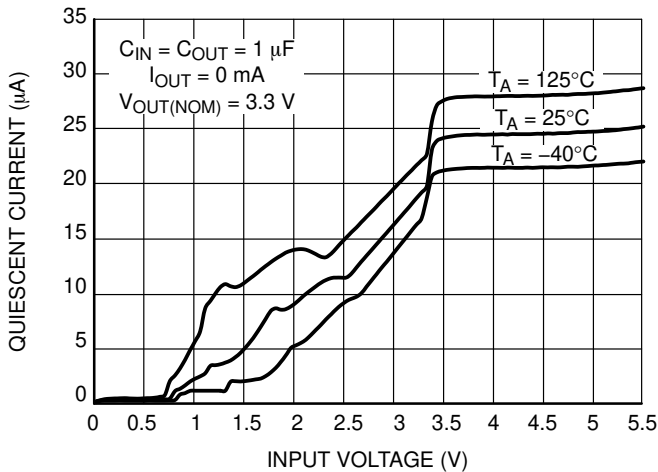


Figure 10. Quiescent Current vs. Temperature  
 $V_{OUT} = 3.3 \text{ V}$

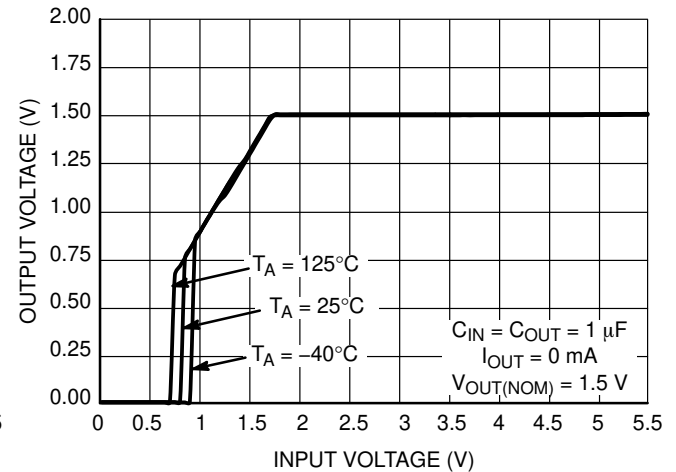
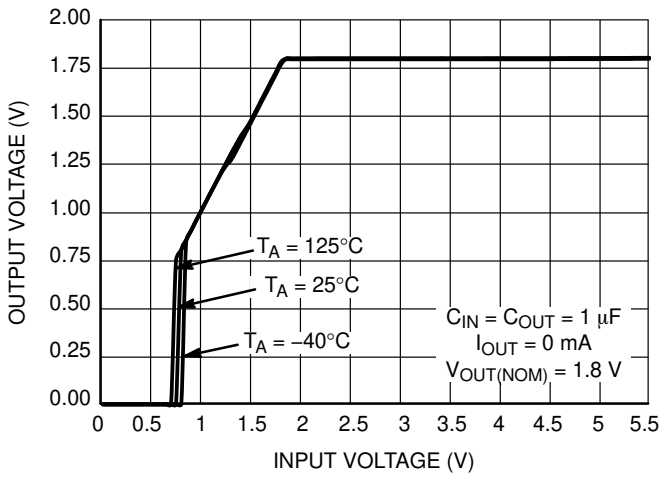
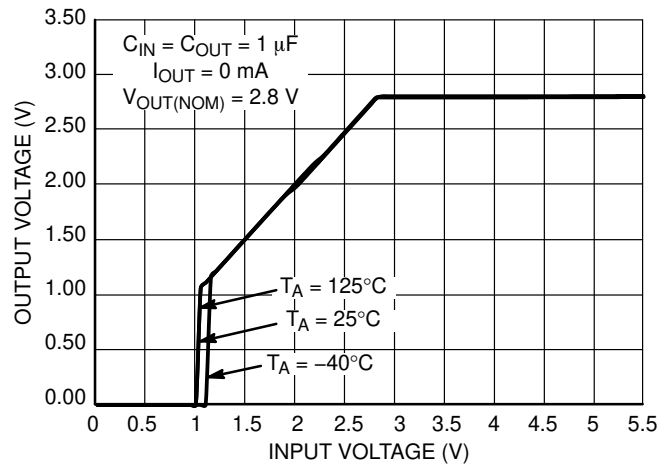


Figure 11. Output Voltage vs. Input Voltage  
 $V_{OUT} = 1.5 \text{ V}$

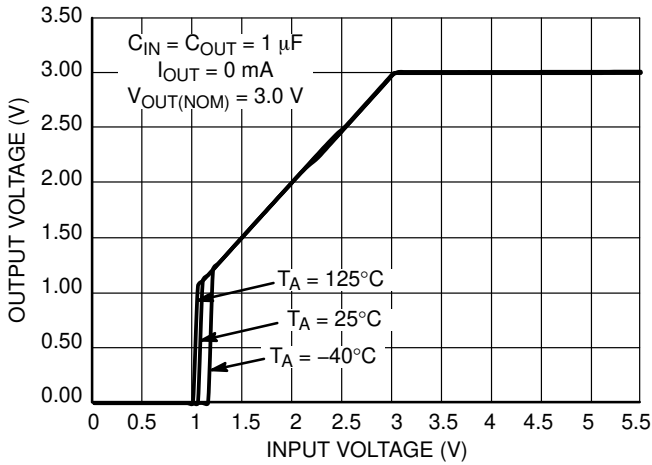
# NCP717



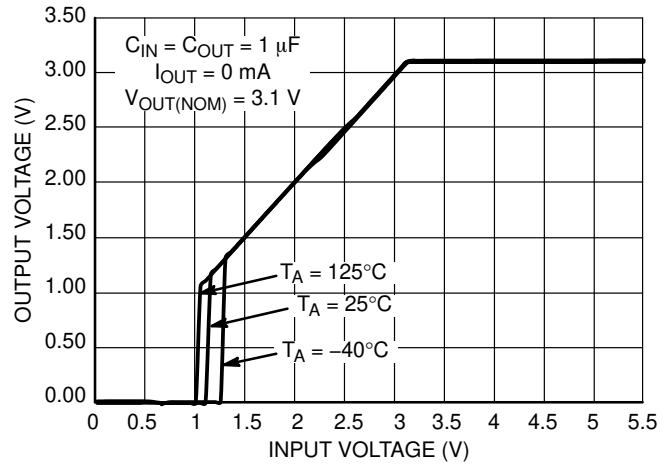
**Figure 12. Output Voltage vs. Input Voltage**  
 $V_{OUT} = 1.8\text{ V}$



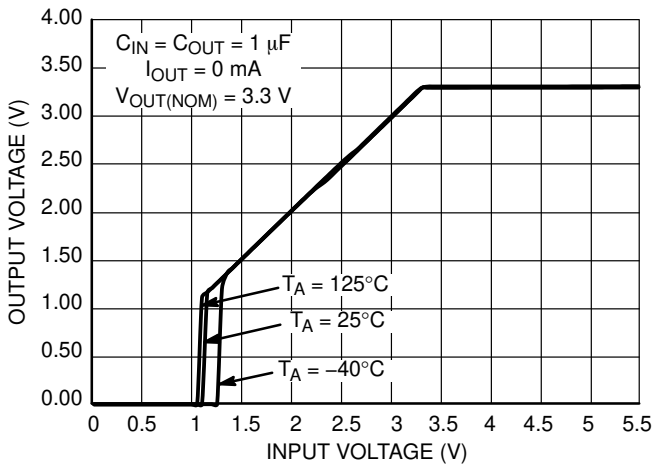
**Figure 13. Output Voltage vs. Input Voltage**  
 $V_{OUT} = 2.8\text{ V}$



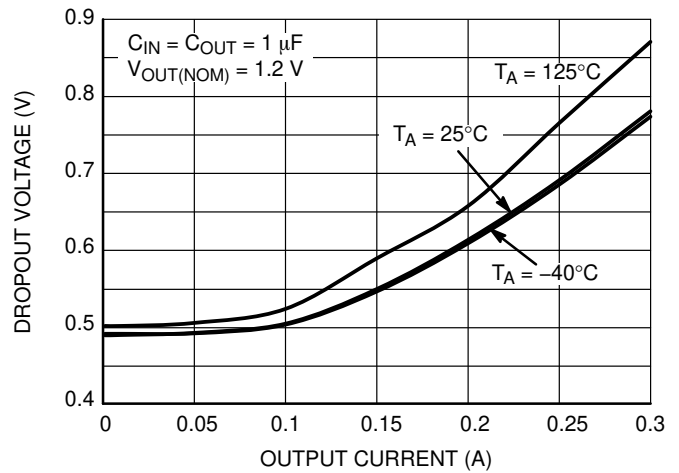
**Figure 14. Output Voltage vs. Input Voltage**  
 $V_{OUT} = 3.0\text{ V}$



**Figure 15. Output Voltage vs. Input Voltage**  
 $V_{OUT} = 3.1\text{ V}$

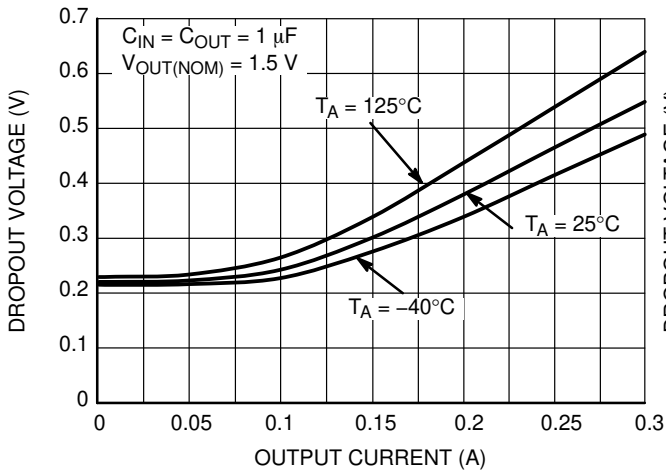


**Figure 16. Output Voltage vs. Input Voltage**  
 $V_{OUT} = 3.3\text{ V}$

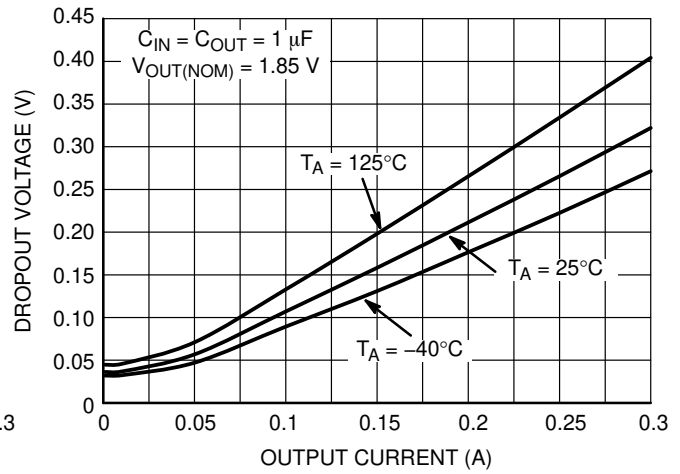


**Figure 17. Dropout Voltage vs. Output Current**  
 $V_{OUT} = 1.2\text{ V}$

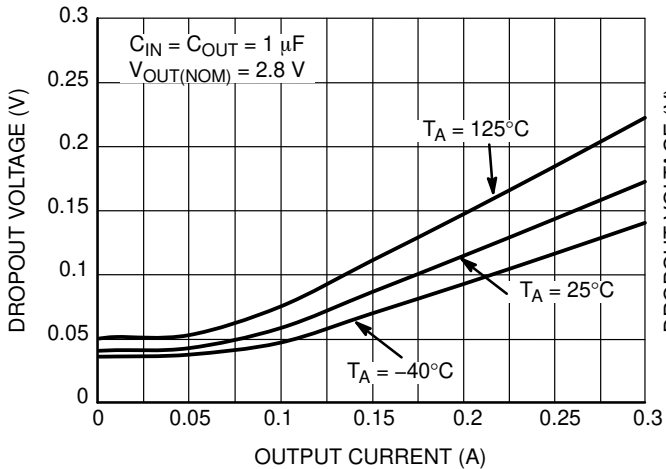
# NCP717



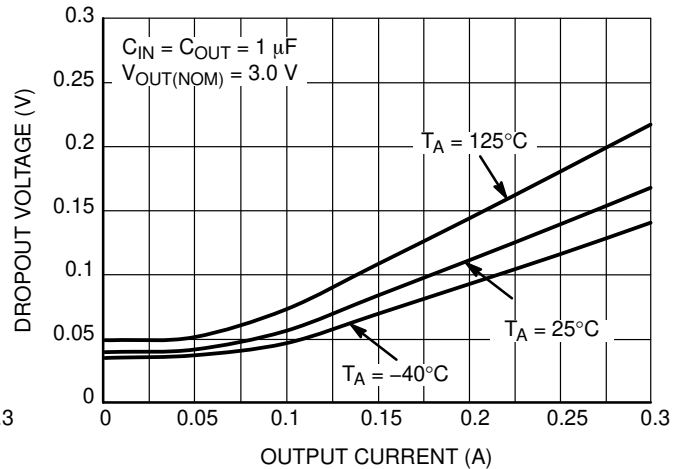
**Figure 18. Dropout Voltage vs. Output Current**  
 $V_{OUT} = 1.5\text{ V}$



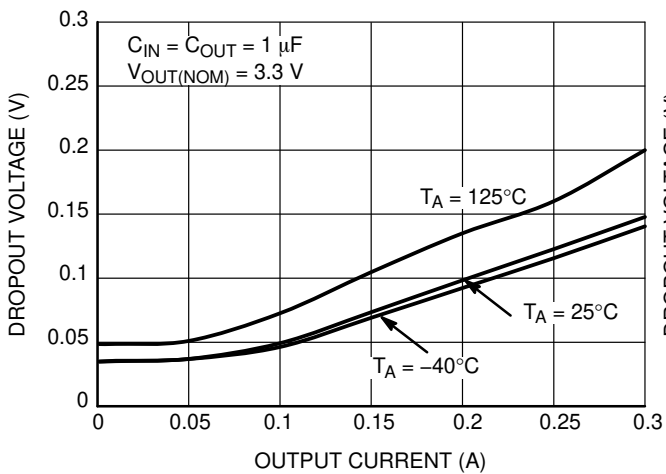
**Figure 19. Dropout Voltage vs. Output Current**  
 $V_{OUT} = 1.85\text{ V}$



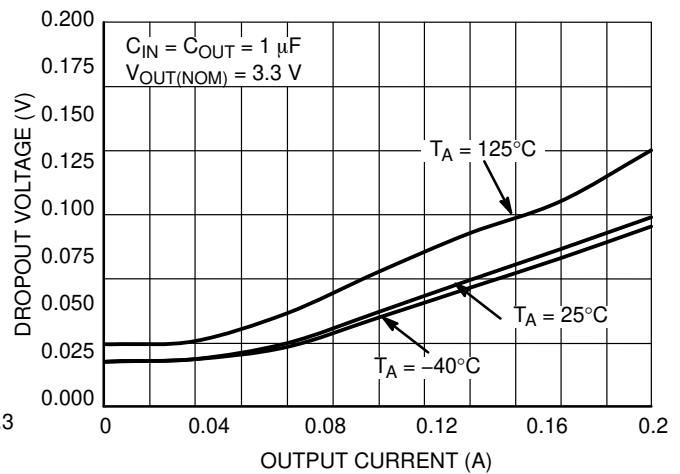
**Figure 20. Dropout Voltage vs. Output Current**  
 $V_{OUT} = 2.8\text{ V}$



**Figure 21. Dropout Voltage vs. Output Current**  
 $V_{OUT} = 3.0\text{ V}$



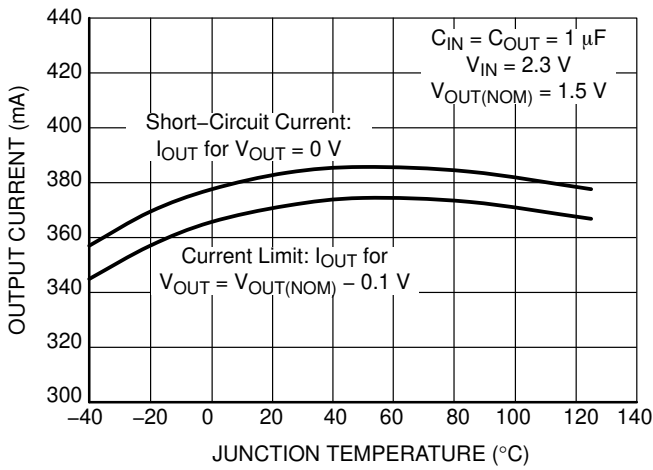
**Figure 22. Dropout Voltage vs. Output Current**  
 $V_{OUT} = 3.1\text{ V}$



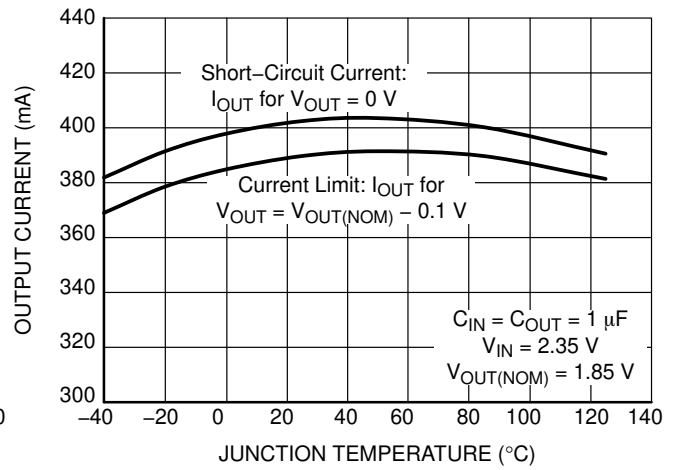
**Figure 23. Dropout Voltage vs. Output Current**  
 $V_{OUT} = 3.3\text{ V}$



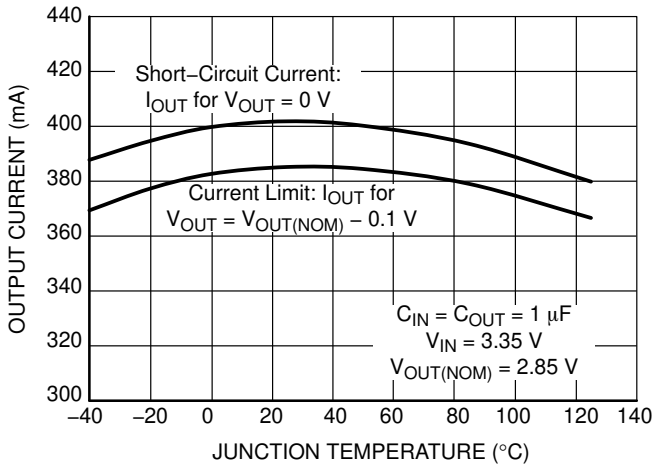
# NCP717



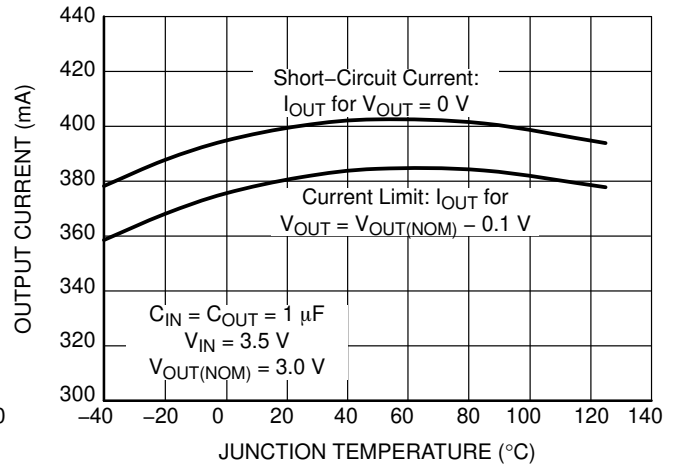
**Figure 24. Short-Circuit Limit vs. Temperature**  
**V<sub>OUT</sub> = 1.5 V**



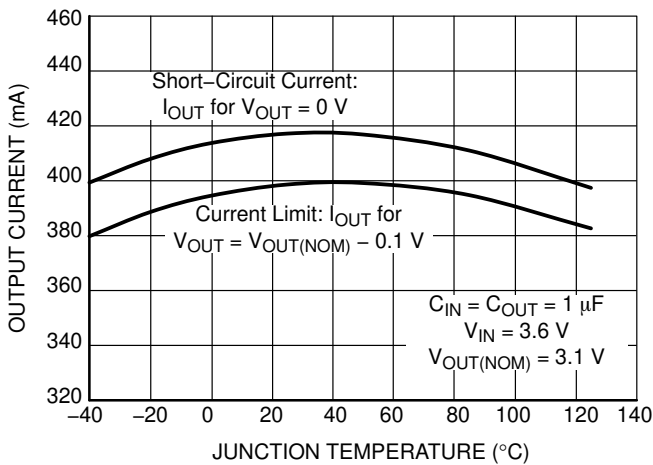
**Figure 25. Short-Circuit Limit vs. Temperature**  
**V<sub>OUT</sub> = 1.85 V**



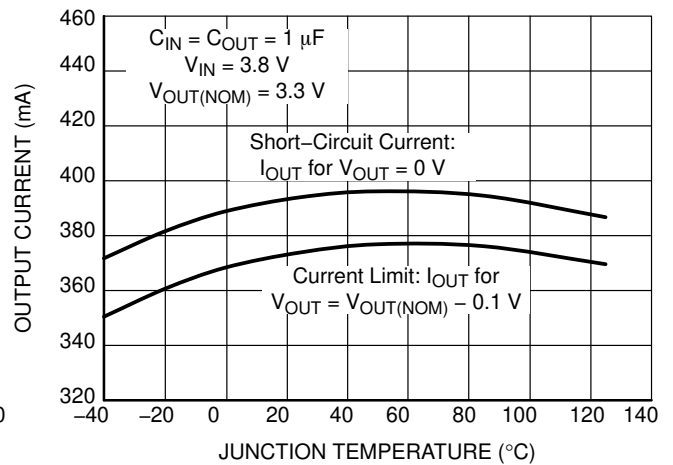
**Figure 26. Short-Circuit Limit vs. Temperature**  
**V<sub>OUT</sub> = 2.85 V**



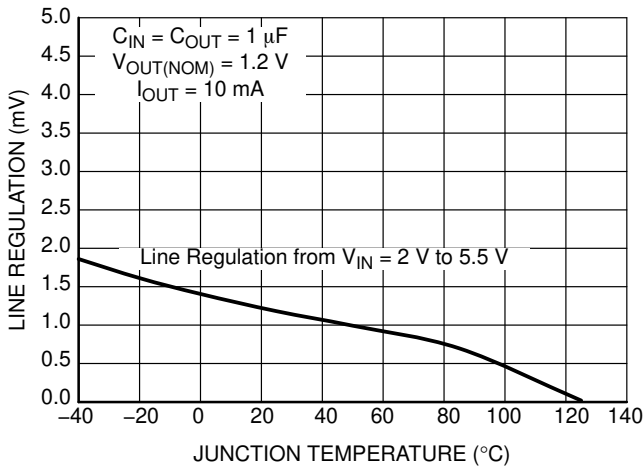
**Figure 27. Short-Circuit Limit vs. Temperature**  
**V<sub>OUT</sub> = 3.0 V**



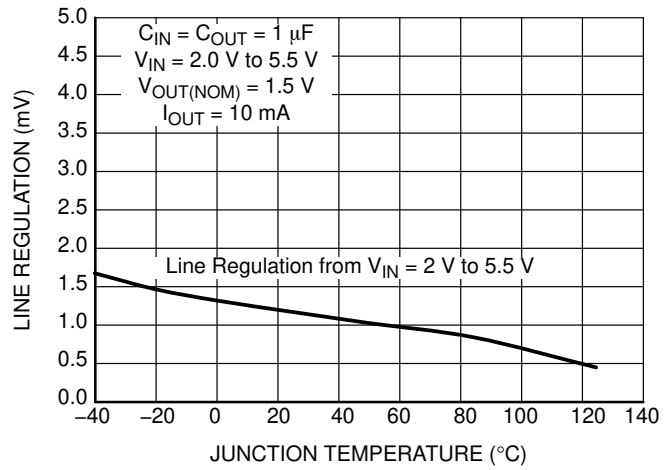
**Figure 28. Short-Circuit Limit vs. Temperature**  
**V<sub>OUT</sub> = 3.1 V**



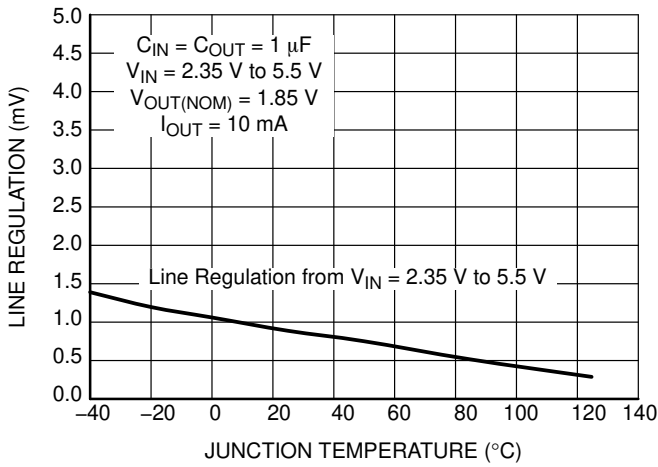
**Figure 29. Short-Circuit Limit vs. Temperature**  
**V<sub>OUT</sub> = 3.3 V**



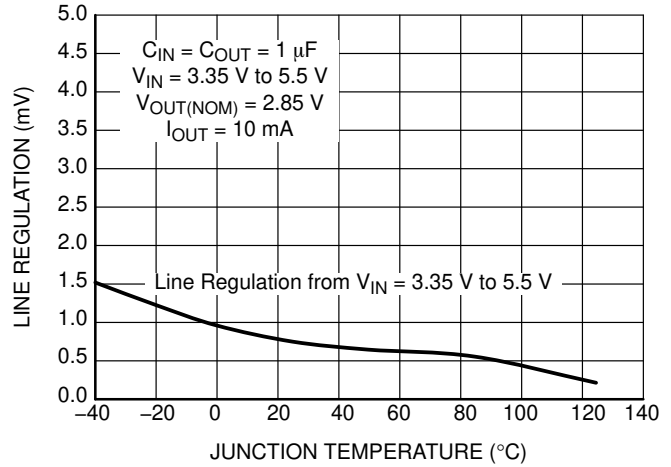
**Figure 30. Line Regulation vs. Temperature**  
**V<sub>OUT</sub> = 1.2 V**



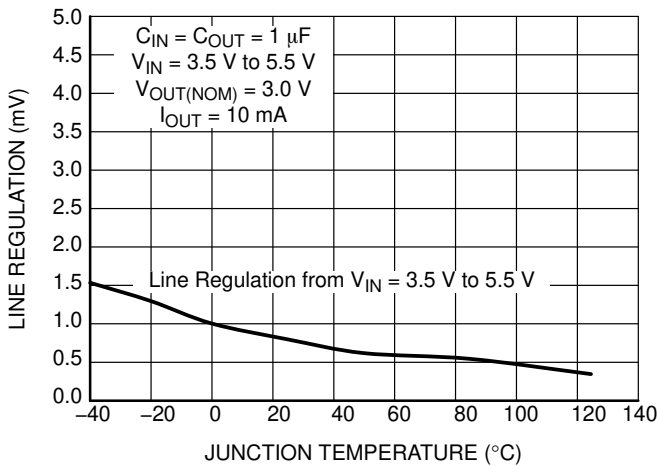
**Figure 31. Line Regulation vs. Temperature**  
**V<sub>OUT</sub> = 1.5 V**



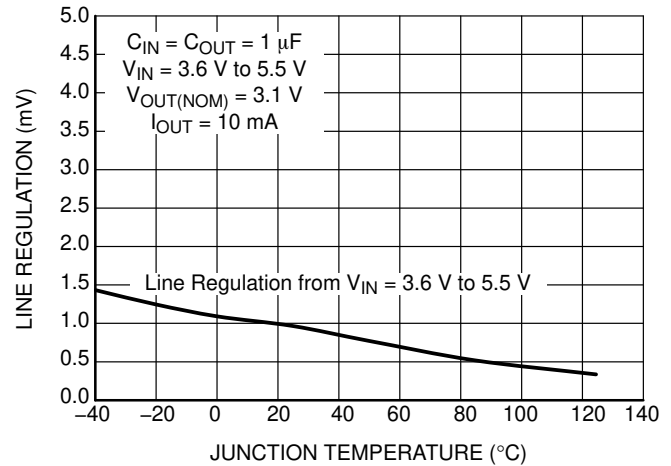
**Figure 32. Line Regulation vs. Temperature**  
**V<sub>OUT</sub> = 1.85 V**



**Figure 33. Line Regulation vs. Temperature**  
**V<sub>OUT</sub> = 2.85 V**

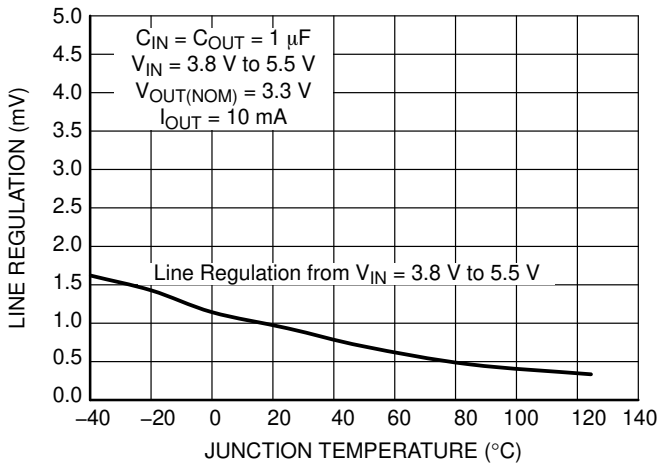


**Figure 34. Line Regulation vs. Temperature**  
**V<sub>OUT</sub> = 3.0 V**

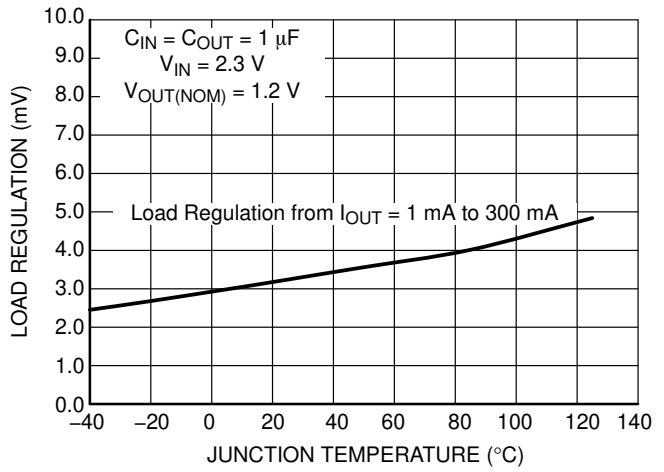


**Figure 35. Line Regulation vs. Temperature**  
**V<sub>OUT</sub> = 3.1 V**

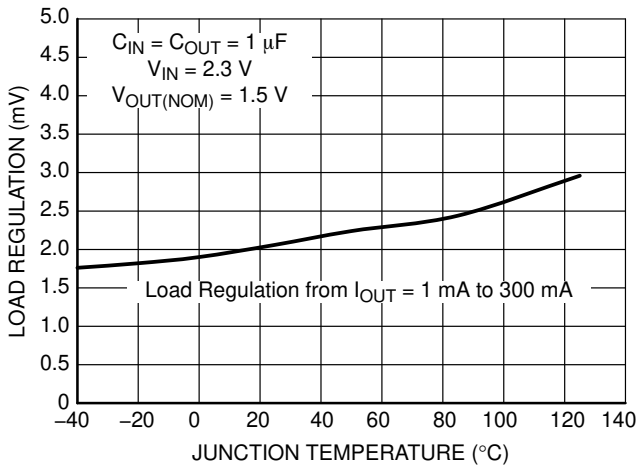
# NCP717



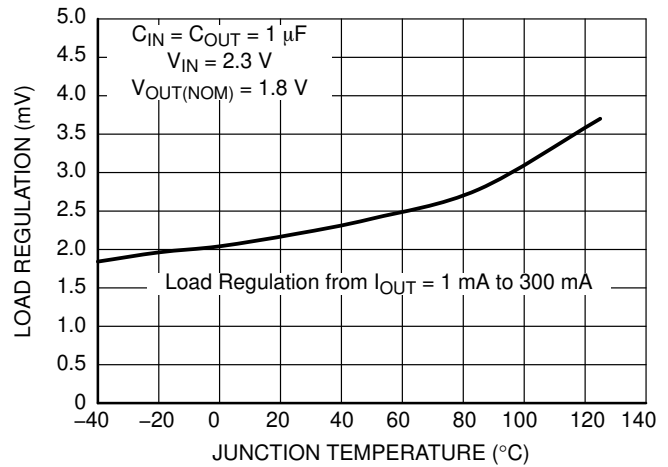
**Figure 36. Line Regulation vs. Temperature**  
 $V_{OUT} = 3.3 \text{ V}$



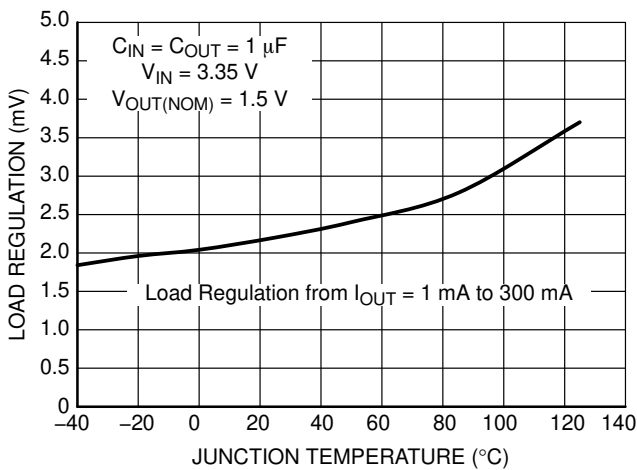
**Figure 37. Load Regulation vs. Temperature**  
 $V_{OUT} = 1.2 \text{ V}$



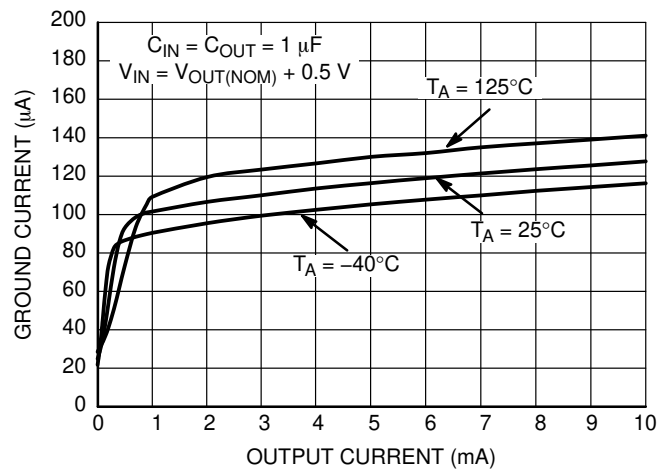
**Figure 38. Load Regulation vs. Temperature**  
 $V_{OUT} = 1.5 \text{ V}$



**Figure 39. Load Regulation vs. Temperature**  
 $V_{OUT} = 1.8 \text{ V}$



**Figure 40. Load Regulation vs. Temperature**  
 $V_{OUT} = 2.85 \text{ V}$



**Figure 41. Ground Current vs. Output Current**

# NCP717

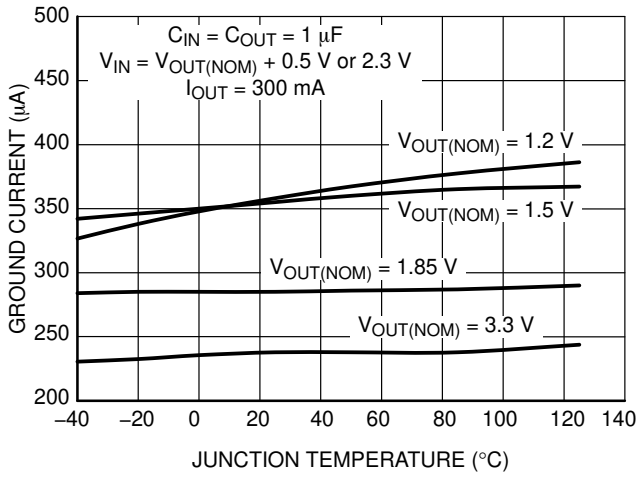


Figure 42. Ground Current vs. Temperature

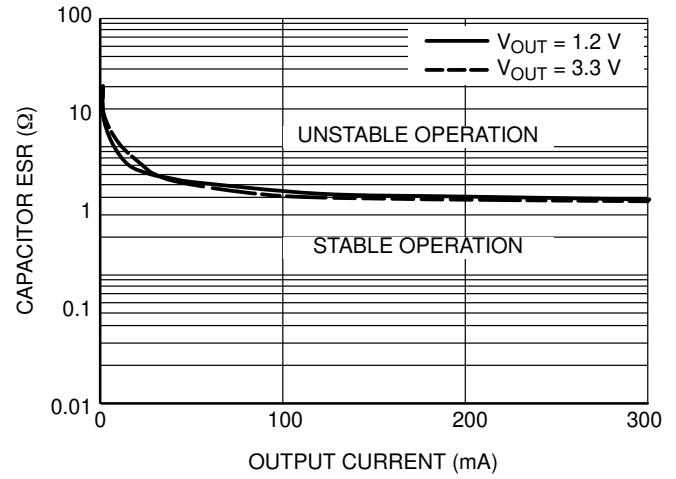


Figure 43. Stability vs. Output Capacitor ESR

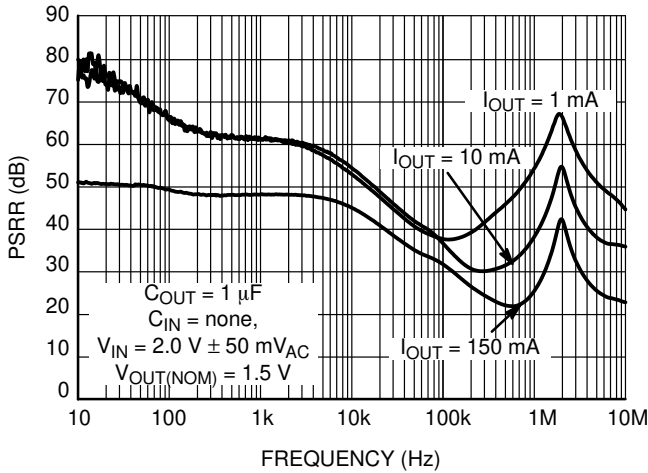


Figure 44. PSRR vs. Frequency  
V<sub>OUT</sub> = 1.5 V

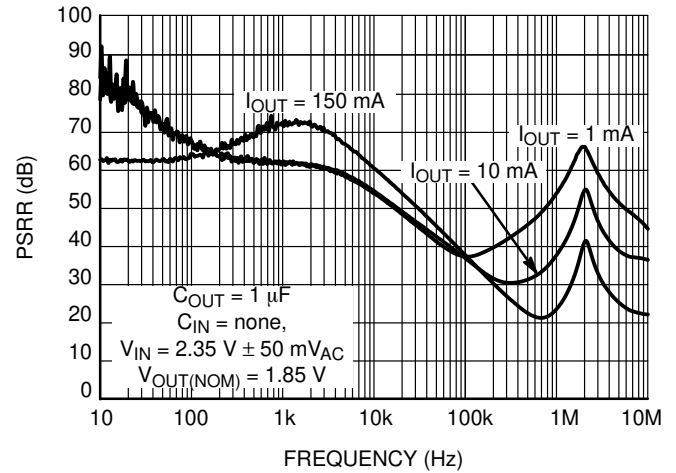


Figure 45. PSRR vs. Frequency  
V<sub>OUT</sub> = 1.85 V

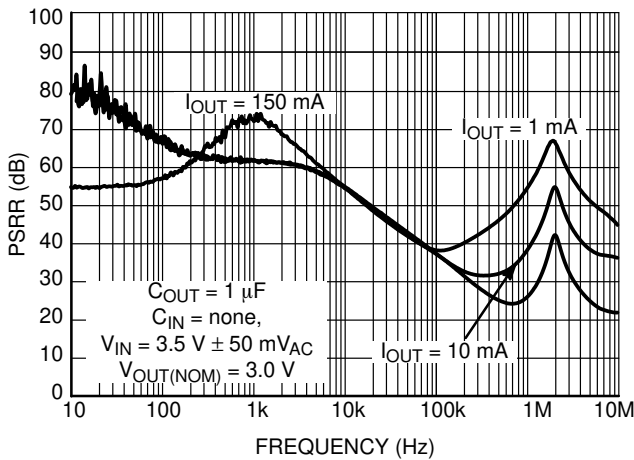


Figure 46. PSRR vs. Frequency  
V<sub>OUT</sub> = 3.0 V

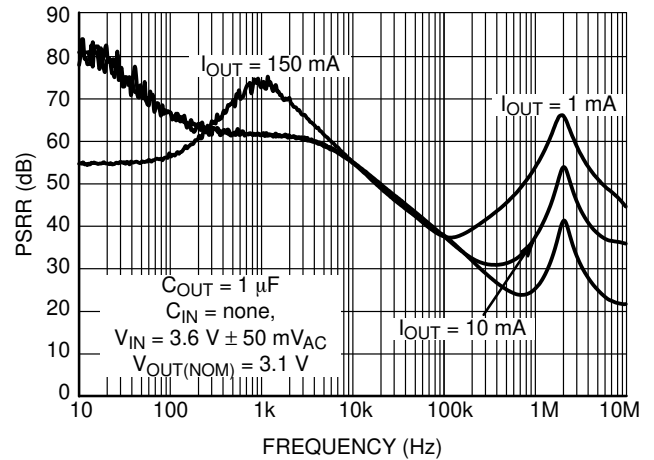
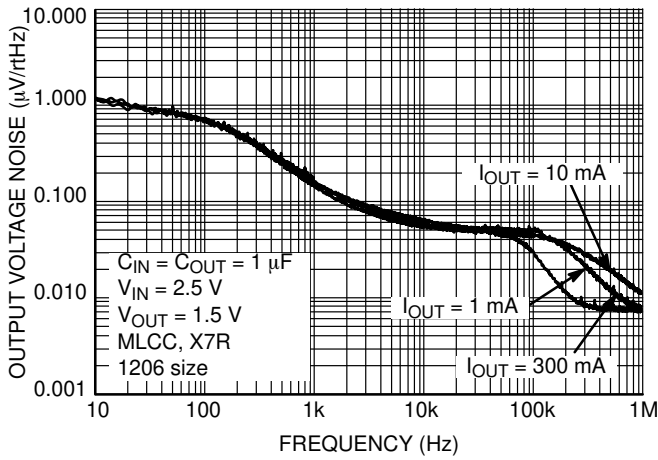
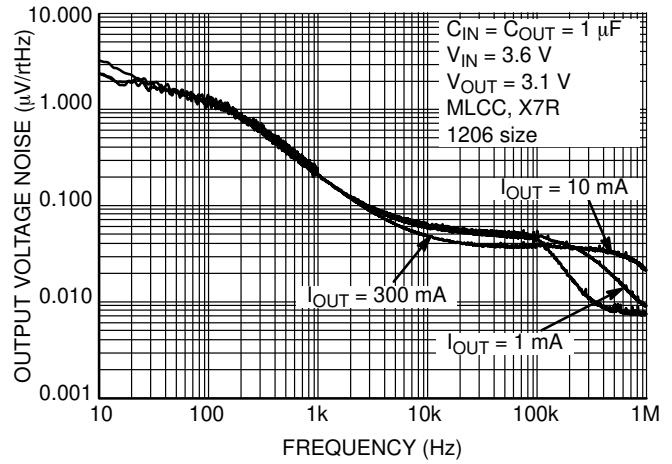


Figure 47. PSRR vs. Frequency  
V<sub>OUT</sub> = 3.1 V

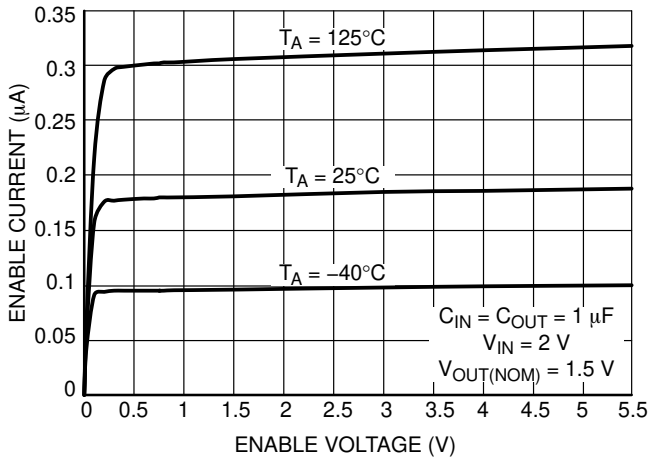
# NCP717



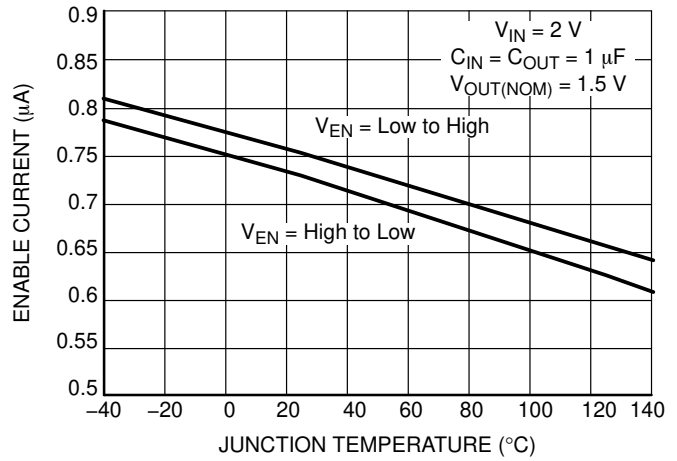
**Figure 48. Output Noise Density vs. Frequency**  
 $V_{OUT} = 1.5\text{ V}$



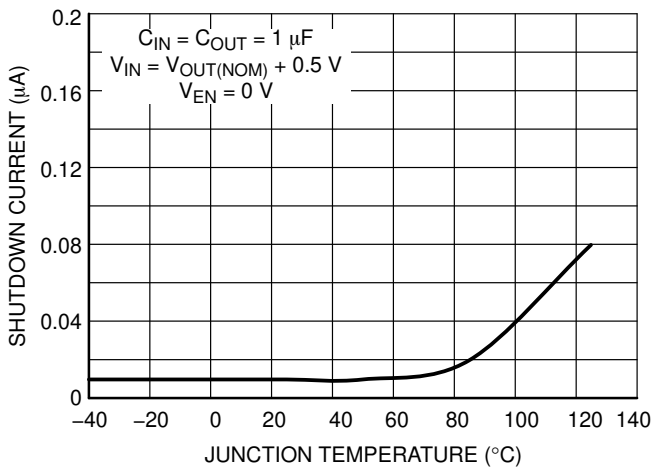
**Figure 49. Output Noise Density vs. Frequency**  
 $V_{OUT} = 3.1\text{ V}$



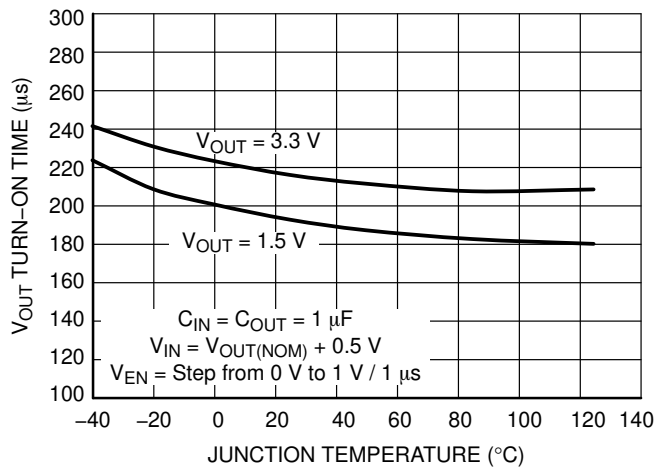
**Figure 50. Enable Input Current vs. Enable Voltage**



**Figure 51. Enable Threshold Voltage vs. Temperature**



**Figure 52. Shutdown Current vs. Temperature**



**Figure 53.  $V_{OUT}$  Turn-on Time vs. Temperature**



## APPLICATIONS INFORMATION

The NCP717 is a high performance, small package size, 300 mA LDO voltage regulator. This device delivers very good noise and dynamic performance. Thanks to its adaptive ground current feature the device consumes only 25  $\mu$ A of quiescent current at no-load condition. The regulator features very-low noise of 22  $\mu$ VRMS, PSRR of typ. 70 dB at 1 kHz and very good load/line transient response. The device is an ideal choice for space constrained portable applications.

A logic EN input provides ON/OFF control of the output voltage. When the EN is low the device consumes as low as typ. 10 nA from the IN pin.

The device is fully protected in case of output overload, output short circuit condition and overheating, assuring a very robust design.

**Input Capacitor Selection ( $C_{IN}$ )**

It is recommended to connect a minimum of 1  $\mu$ F Ceramic X5R or X7R capacitor close to the IN pin of the device. Larger input capacitors may be necessary if fast and large load transients are encountered in the application. There is no requirement for the min./max. ESR of the input capacitor but it is recommended to use ceramic capacitors for their low ESR and ESL.

**Output Capacitor Selection ( $C_{OUT}$ )**

The NCP717 is designed to be stable with small 1.0  $\mu$ F and larger ceramic capacitors on the output. The minimum effective output capacitance for which the LDO remains stable is 100 nF. The safety margin is provided to account for capacitance variations due to DC bias voltage, temperature, initial tolerance. There is no requirement for the minimum value of Equivalent Series Resistance (ESR) for the  $C_{OUT}$  but the maximum value of ESR should be less than 700 m $\Omega$ .

Larger output capacitors could be used to improve the load transient response or high frequency PSRR characteristics. It is not recommended to use tantalum capacitors on the output due to their large ESR. The equivalent series resistance of tantalum capacitors is also strongly dependent on the temperature, increasing at low temperature. The tantalum capacitors are generally more costly than ceramic capacitors.

**No-load Operation**

The regulator remains stable and regulates the output voltage properly within the  $\pm 2\%$  tolerance limits even with no external load applied to the output.

**Enable Operation**

The NCP717 uses the EN pin to enable/disable its output and to control the active discharge function. If the EN pin voltage is  $< 0.4$  V the device is guaranteed to be disabled. The pass transistor is turned – off so that there is virtually no current flow between the IN and OUT. In case of the option equipped with active discharge – the active discharge transistor is turned–on and the output voltage  $V_{OUT}$  is pulled

to GND through a 1.2 k $\Omega$  resistor (A version) or 120  $\Omega$  (C version). In the disable state the device consumes as low as typ. 10 nA from the  $V_{IN}$ . If the EN pin voltage  $> 0.9$  V the device is guaranteed to be enabled. The NCP717 regulates the output voltage and the active discharge transistor is turned–off. The EN pin has an internal pull–down current source with typ. value of 180 nA which assures that the device is turned–off when the EN pin is not connected. A build in 56 mV of hysteresis and deglitch time in the EN block prevents from periodic on/off oscillations that can occur due to noise on EN line. In the case that the EN function isn't required the EN pin should be tied directly to IN.

**Reverse Current**

The PMOS pass transistor has an inherent body diode which will be forward biased in the case that  $V_{OUT} > V_{IN}$ . Due to this fact in cases where the extended reverse current condition is anticipated the device may require additional external protection.

**Output Current Limit**

Output Current is internally limited within the IC to a typical 379 mA. The NCP717 will source this amount of current measured with the output voltage 100 mV lower than the nominal  $V_{OUT}$ . If the Output Voltage is directly shorted to ground ( $V_{OUT} = 0$  V), the short circuit protection will limit the output current to 390 mA (typ). The current limit and short circuit protection will work properly up to  $V_{IN} = 5.5$  V at  $T_A = 25^\circ\text{C}$ . There is no limitation for the short circuit duration.

**Thermal Shutdown**

When the die temperature exceeds the Thermal Shutdown threshold (TSD – 160 $^\circ\text{C}$  typical), Thermal Shutdown event is detected and the device is disabled. The IC will remain in this state until the die temperature decreases below the Thermal Shutdown Reset threshold (TSDU – 140 $^\circ\text{C}$  typical). Once the IC temperature falls below the 140 $^\circ\text{C}$  the LDO is enabled again. The thermal shutdown feature provides protection from a catastrophic device failure due to accidental overheating. This protection is not intended to be used as a substitute for proper heat sinking.

**Power Dissipation**

As power dissipated in the NCP717 increases, it might become necessary to provide some thermal relief. The maximum power dissipation supported by the device is dependent upon board design and layout. Mounting pad configuration on the PCB, the board material, and the ambient temperature affect the rate of junction temperature rise for the part. The maximum power dissipation the NCP717 can handle is given by:

$$P_{D(\text{MAX})} = \frac{[125 - T_A]}{\theta_{JA}} \quad (\text{eq. 1})$$

## NCP717

For reliable operation junction temperature should be limited to +125°C.

The power dissipated by the NCP717 for given application conditions can be calculated as follows:

$$P_{D(MAX)} = V_{IN}I_{GND} + I_{OUT}(V_{IN} - V_{OUT}) \quad (\text{eq. 2})$$

Figure 54 shows the typical values of  $\theta_{JA}$  vs. heat spreading area.

### Load Regulation

The NCP717 features very good load regulation of typical 3.6 mV in the 0 mA to 300 mA range. In order to achieve this very good load regulation a special attention to PCB design is necessary. The trace resistance from the OUT pin to the

point of load can easily approach 100 m $\Omega$  which will cause a 68 mV voltage drop at full load current, deteriorating the excellent load regulation.

### Line Regulation

The IC features very good line regulation of 0.4 mV/V measured from  $V_{IN} = V_{OUT} + 0.5 \text{ V}$  to 5.5 V.

### Power Supply Rejection Ratio

At low frequencies the PSRR is mainly determined by the feedback open-loop gain. At higher frequencies in the range 100 kHz – 10 MHz it can be tuned by the selection of  $C_{OUT}$  capacitor and proper PCB layout.

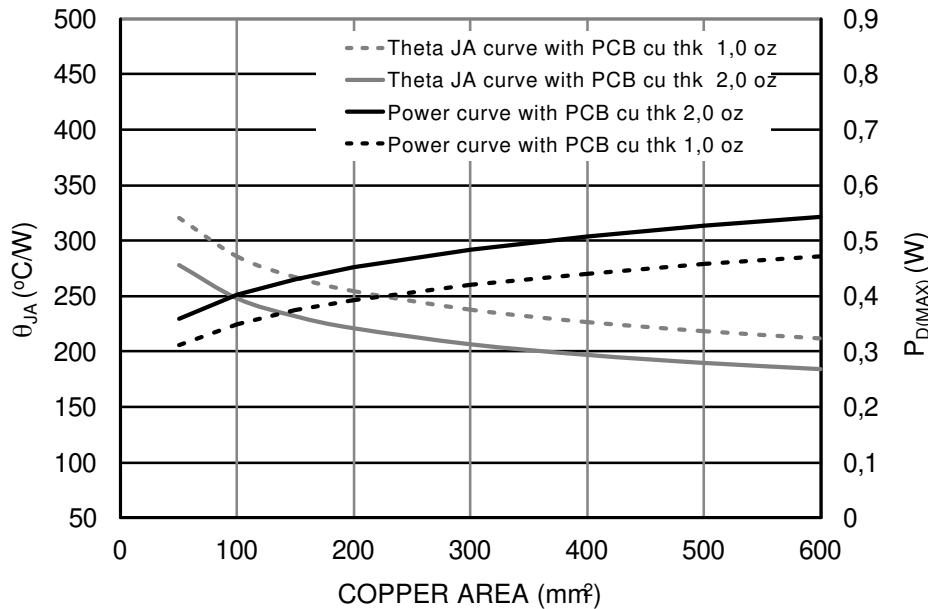


Figure 54. Thermal Parameters vs. Copper Area

### Output Noise

The IC is designed for very-low output voltage noise. The typical noise performance of 22  $\mu\text{V}_{\text{RMS}}$  makes the device suitable for noise sensitive applications.

### Internal Soft Start

The Internal Soft-Start circuitry will limit the inrush current during the LDO turn-on phase. Please refer to typical characteristics section for typical inrush current values. The soft-start function prevents from any output

voltage overshoots and assures monotonic ramp-up of the output voltage.

### PCB Layout Recommendations

To obtain good transient performance and good regulation characteristics place  $C_{IN}$  and  $C_{OUT}$  capacitors close to the device pins and make the PCB traces wide. In order to minimize the solution size use 0402 capacitors. Larger copper area connected to the pins will also improve the device thermal resistance. The actual power dissipation can be calculated by the formula given in Equation 2.

# NCP717

## ORDERING INFORMATION

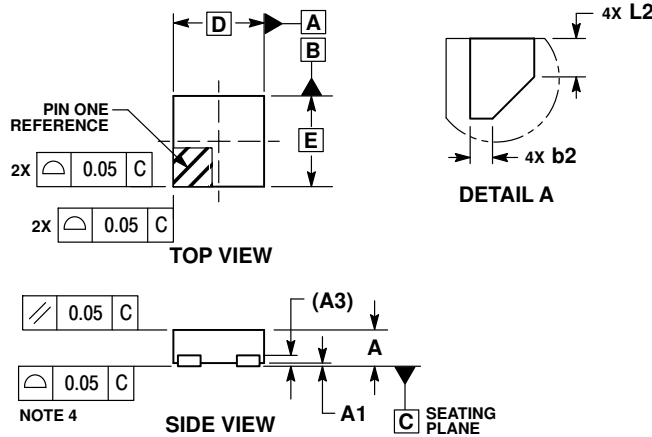
Device	Voltage Option	Marking	Marking Rotation	Option	Package	Shipping <sup>†</sup>
NCP717AMX150TCG	1.5 V	R	0°	With active output discharge function $R_{DIS}=1.2\text{ k}\Omega$	XDFN4 (Pb-Free)	3000 / Tape & Reel
NCP717AMX180TCG	1.8 V	T	0°			
NCP717AMX185TCG	1.85 V	V	0°			
NCP717AMX190TCG	1.9 V	6	0°			
NCP717AMX250TCG	2.5 V	T	180°			
NCP717AMX280TCG	2.8 V	Y	0°			
NCP717AMX285TCG	2.85 V	2	0°			
NCP717AMX300TCG	3.0 V	3	0°			
NCP717AMX310TCG	3.1 V	4	0°			
NCP717AMX330TCG	3.3 V	5	0°			
NCP717BMX150TCG	1.5 V	R	90°	Without active output discharge function		
NCP717BMX180TCG	1.8 V	T	90°			
NCP717BMX185TCG	1.85 V	V	90°			
NCP717BMX190TCG	1.9 V	6	90°			
NCP717BMX250TCG	2.5 V	T	270°			
NCP717BMX280TCG	2.8 V	Y	90°			
NCP717BMX285TCG	2.85 V	2	90°			
NCP717BMX300TCG	3.0 V	3	90°			
NCP717BMX310TCG	3.1 V	4	90°			
NCP717BMX330TCG	3.3 V	5	90°			
NCP717CMX135TCG	1.35 V	D	270°	With active output discharge function $R_{DIS}=120\ \Omega$		
NCP717CMX150TCG	1.5 V	L	270°			
NCP717CMX180TCG	1.8 V	P	270°			
NCP717CMX185TCG	1.85 V	Q	270°			
NCP717CMX190TCG	1.9 V	R	270°			
NCP717CMX220TCG	2.2 V	A	270°			
NCP717CMX250TCG	2.5 V	V	270°			
NCP717CMX280TCG	2.8 V	Y	270°			
NCP717CMX285TBM	2.85 V	2	270°			
NCP717CMX285TCG	2.85 V	2	270°			
NCP717CMX300TCG	3.0 V	3	270°			
NCP717CMX310TCG	3.1 V	4	270°			
NCP717CMX320TCG	3.2 V	5	270°			
NCP717CMX330TBM	3.3 V	6	270°			
NCP717CMX330TCG	3.3 V	6	270°			

<sup>†</sup>For information on tape and reel specifications, including part orientation and tape sizes, please refer to our Tape and Reel Packaging Specifications Brochure, BRD8011/D.

# NCP717

## PACKAGE DIMENSIONS

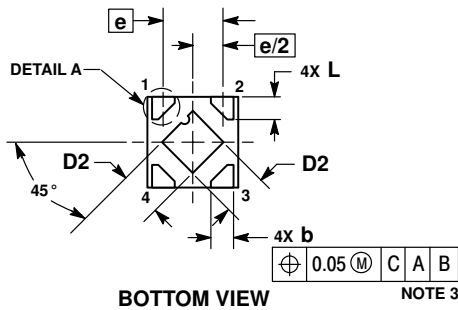
### XDFN4 1.0x1.0, 0.65P CASE 711AJ ISSUE O



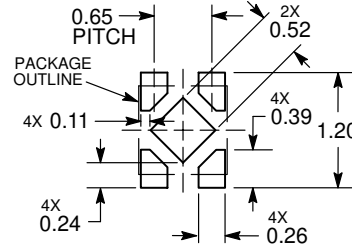
#### NOTES:

1. DIMENSIONING AND TOLERANCING PER ASME Y14.5M, 1994.
2. CONTROLLING DIMENSION: MILLIMETERS.
3. DIMENSION b APPLIES TO PLATED TERMINAL AND IS MEASURED BETWEEN 0.15 AND 0.20 mm FROM THE TERMINAL TIPS.
4. COPLANARITY APPLIES TO THE EXPOSED PAD AS WELL AS THE TERMINALS.

MILLIMETERS		
DIM	MIN	MAX
A	0.33	0.43
A1	0.00	0.05
A3	0.10	REF
b	0.15	0.25
b2	0.02	0.12
D	1.00	BSC
D2	0.43	0.53
E	1.00	BSC
e	0.65	BSC
L	0.20	0.30
L2	0.07	0.17



### RECOMMENDED MOUNTING FOOTPRINT\*



DIMENSIONS: MILLIMETERS

\*For additional information on our Pb-Free strategy and soldering details, please download the ON Semiconductor Soldering and Mounting Techniques Reference Manual, SOLDERRM/D.

Bluetooth is a registered trademark of Bluetooth SIG.  
ZigBee is a registered trademark of ZigBee Alliance.

ON Semiconductor and are registered trademarks of Semiconductor Components Industries, LLC (SCILLC). SCILLC owns the rights to a number of patents, trademarks, copyrights, trade secrets, and other intellectual property. A listing of SCILLC's product/patent coverage may be accessed at [www.onsemi.com/site/pdf/Patent-Marking.pdf](http://www.onsemi.com/site/pdf/Patent-Marking.pdf). SCILLC reserves the right to make changes without further notice to any products herein. SCILLC makes no warranty, representation or guarantee regarding the suitability of its products for any particular purpose, nor does SCILLC assume any liability arising out of the application or use of any product or circuit, and specifically disclaims any and all liability, including without limitation special, consequential or incidental damages. "Typical" parameters which may be provided in SCILLC data sheets and/or specifications can and do vary in different applications and actual performance may vary over time. All operating parameters, including "Typicals" must be validated for each customer application by customer's technical experts. SCILLC does not convey any license under its patent rights nor the rights of others. SCILLC products are not designed, intended, or authorized for use as components in systems intended for surgical implant into the body, or other applications intended to support or sustain life, or for any other application in which the failure of the SCILLC product could create a situation where personal injury or death may occur. Should Buyer purchase or use SCILLC products for any such unintended or unauthorized application, Buyer shall indemnify and hold SCILLC and its officers, employees, subsidiaries, affiliates, and distributors harmless against all claims, costs, damages, and expenses, and reasonable attorney fees arising out of, directly or indirectly, any claim of personal injury or death associated with such unintended or unauthorized use, even if such claim alleges that SCILLC was negligent regarding the design or manufacture of the part. SCILLC is an Equal Opportunity/Affirmative Action Employer. This literature is subject to all applicable copyright laws and is not for resale in any manner.

### PUBLICATION ORDERING INFORMATION

**LITERATURE FULFILLMENT:**  
Literature Distribution Center for ON Semiconductor  
P.O. Box 5163, Denver, Colorado 80217 USA  
Phone: 303-675-2175 or 800-344-3860 Toll Free USA/Canada  
Fax: 303-675-2176 or 800-344-3867 Toll Free USA/Canada  
Email: [orderlit@onsemi.com](mailto:orderlit@onsemi.com)

**N. American Technical Support:** 800-282-9855 Toll Free  
USA/Canada  
**Europe, Middle East and Africa Technical Support:**  
Phone: 421 33 790 2910  
**Japan Customer Focus Center**  
Phone: 81-3-5817-1050

**ON Semiconductor Website:** [www.onsemi.com](http://www.onsemi.com)  
**Order Literature:** <http://www.onsemi.com/orderlit>  
For additional information, please contact your local Sales Representative