



Chipsmall Limited consists of a professional team with an average of over 10 year of expertise in the distribution of electronic components. Based in Hongkong, we have already established firm and mutual-benefit business relationships with customers from,Europe,America and south Asia,supplying obsolete and hard-to-find components to meet their specific needs.

With the principle of “Quality Parts,Customers Priority,Honest Operation,and Considerate Service”,our business mainly focus on the distribution of electronic components. Line cards we deal with include Microchip,ALPS,ROHM,Xilinx,Pulse,ON,Everlight and Freescale. Main products comprise IC,Modules,Potentiometer,IC Socket,Relay,Connector.Our parts cover such applications as commercial,industrial, and automotives areas.

We are looking forward to setting up business relationship with you and hope to provide you with the best service and solution. Let us make a better world for our industry!



## Contact us

Tel: +86-755-8981 8866 Fax: +86-755-8427 6832

Email & Skype: info@chipsmall.com Web: www.chipsmall.com

Address: A1208, Overseas Decoration Building, #122 Zhenhua RD., Futian, Shenzhen, China





### FEATURES

- UL 60950 recognised
- 4:1 Wide range voltage input
- Operating temperature range -40°C to 85°C with derating
- 1.5 kVDC Isolation 'Hi Pot Test'
- 3.3V, 5V, 12V & 15V outputs
- No electrolytic capacitors
- Continuous short circuit protection

### PRODUCT OVERVIEW

The NCS3 series of DC/DC converters offers a single output voltage from input voltage ranges of 9-36V and 18-75V. The NCS3 is housed in an industry standard package with a standard pinout.

Applications include telecommunications, battery powered systems, process control and distributed power systems.

### SELECTION GUIDE

Order Code	Input Voltage	Output Voltage	Minimum Load	Rated Input Current 12V or 48V Input.	Rated Input Current 24V Input.	Output Current	Efficiency 12V or 48V Input.		Efficiency 24V Input.		Ripple and Noise		MTTF <sup>1</sup> kHrs
	Nom.						Min.	Typ.	Min.	Typ.	Typ.	Max.	
	V	V					%	%	%	%	mVp/p	mVp/p	
NCS3S1203SC	12	3.3	10	250	125	700	74	77	73	76	32	55	1335
NCS3S1205SC	12	5	5	305	150	600	79	82	79	81	34	60	1081
NCS3S1212SC	12	12	0	300	150	250	81	84	80	83	28	55	1272
NCS3S1215SC	12	15	0	300	150	200	82	86	81	85	20	50	1617
NCS3S4803SC	48	3.3	10	124	65	700	70	74	74	77	22	55	1327
NCS3S4805SC	48	5	5	153	80	600	77.5	80	79	81	36	75	1117
NCS3S4812SC	48	12	0	150	80	250	77	81	80	83	31	65	1211
NCS3S4815SC	48	15	0	149	80	200	78	81	81	83	22	55	1574

### INPUT CHARACTERISTICS

Parameter	Conditions	Min.	Typ.	Max.	Units
Voltage range	12V input types	9	12	36	V
	48V input types	18	48	75	
Input reflected ripple current	NCS3S12XX	12V input types	5.5		mA p-p
		24V input types	2		
	NCS3S48XX	24V input types	3.5		
		48V input types	2		
Power consumption at shutdown			2		mW
Input current in shutdown				2.5	mA

### OUTPUT CHARACTERISTICS

Parameter	Conditions	Min.	Typ.	Max.	Units
Rated power	3.3V output types			2.31	W
	All other output types			3	
Voltage set point accuracy	All output types		±1	±2	%
Line regulation	Low line to high line			±0.5	%
Load regulation	All output types			±1	%
Transient response	Peak deviation (12.5-37.5% & 37.5-12.5% swing)			5	%V <sub>out</sub>
	Settling time (within 5% V <sub>out</sub> Nom.)		1.5		ms

### GENERAL CHARACTERISTICS

Parameter	Conditions	Min.	Typ.	Max.	Units
CTRL input current	Please refer to control pin application note	2		8	mA

### ISOLATION CHARACTERISTICS

Parameter	Conditions	Min.	Typ.	Max.	Units
Isolation test voltage	Flash tested for 1 minute	1500			VDC
Isolation Capacitance	NCS3S12XXSC		180		pF
	NCS3S48XXSC		185		
Resistance	Viso = 1kVDC	1			GΩ

### TEMPERATURE CHARACTERISTICS

Parameter	Conditions	Min.	Typ.	Max.	Units
Operation	See derating graphs	-40		85	°C
Storage		-50		115	
Case temperature rise above ambient	100% Load, Nom V <sub>in</sub> , Still Air		30	40	

<sup>1</sup> Calculated using MIL-HDBK-217 FN2, parts stress method with nominal input voltage at full load.

All specifications typical at TA=25°C, nominal input voltage and rated output current unless otherwise specified.



For full details go to  
[www.murata-ps.com/rohs](http://www.murata-ps.com/rohs)

### ABSOLUTE MAXIMUM RATINGS

Short-circuit protection (for SELV input voltages)	Continuous
Control pin input current	8mA
Lead temperature 1.0mm from case for 10 seconds (to JEDEC JESD22-B106 ISS C)	260°C
Input voltage, NCS3 12V input types	40V
Input voltage, NCS3 24V input types	80V

### SWITCHING FREQUENCY

Parameter	Conditions		Min.	Typ.	Max.	Units
NCS3S1203SC	12V input types	10% Load		1200		kHz
		100% Load		280		
	24V input types	10% Load		1620		
		100% Load		460		
NCS3S1205SC	12V input types	10% Load		1200		kHz
		100% Load		270		
	24V input types	10% Load		1690		
		100% Load		490		
NCS3S1212SC	12V input types	10% Load		1220		kHz
		100% Load		310		
	24V input types	10% Load		1680		
		100% Load		570		
NCS3S1215SC	12V input types	10% Load		1130		kHz
		100% Load		310		
	24V input types	10% Load		1580		
		100% Load		570		
NCS3S4803SC	24V input types	10% Load		1020		kHz
		100% Load		270		
	48V input types	10% Load		1440		
		100% Load		450		
NCS3S4805SC	24V input types	10% Load		1190		kHz
		100% Load		260		
	48V input types	10% Load		1590		
		100% Load		470		
NCS3S4812SC	24V input types	10% Load		1180		kHz
		100% Load		1570		
	48V input types	10% Load		310		
		100% Load		560		
NCS3S4815SC	24V input types	10% Load		1180		kHz
		100% Load		330		
	48V input types	10% Load		1590		
		100% Load		610		

### APPLICATION NOTES

#### Recommended Input Capacitor and Maximum Output Capacitance

A 10  $\mu$ F output capacitor is recommended for stability under all operating conditions. Maximum output capacitance should not exceed:

Output Voltage	Maximum Load Capacitance
V	$\mu$ F
3.3	470
5	470
12	220
15	110

**APPLICATION NOTES CONTINUED**

**Start-up times**

Typical start up times for this series, with a typical input voltage rise time of 2.2µs and output capacitance of 10µF, are shown in the table below. The product series will start into the maximum output capacitance with increased start times.

Part No.	Start-up times
	ms
NCS3S1203SC	0.7
NCS3S1205SC	1
NCS3S1212SC	2.2
NCS3S1215SC	2.3
NCS3S4803SC	1.2
NCS3S4805SC	1.1
NCS3S4812SC	1.9
NCS3S4815SC	2.8

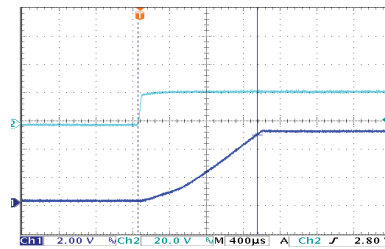

Typical Start-Up Wave Form

**Control Pin**

The NCS3S converters have a shutdown feature which enables the user to disable the converter into a low power state. The control pin connects to the base of an internal NPN transistor through a 1K resistor with the converter shut down when the transistor is turned on by an external applied voltage. The converter can also be shut down using a 5V TTL signal (the unit is OFF for logic High and ON for logic LOW). If the control pin is left open (high impedance), the converter will run normally. A suitable application circuit is shown below.

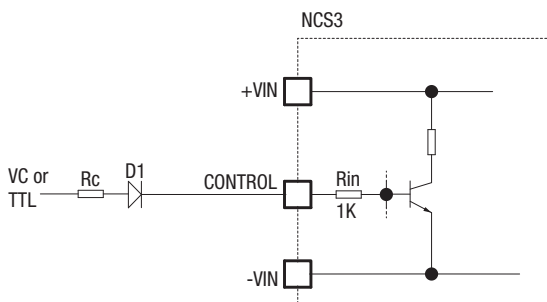

D1 (e.g. 1N4001) is necessary for correct operation of the NCS3 when the control signal is LOW. The recommended drive current  $I_B$  to shut down the NCS3 is 2 mA to 8 mA. The value of  $R_c$  can be derived as follows:

$$R_c = \frac{V_c - V_{D1} - 0.6 - (I_B \times R_{IN})}{I_B}$$

Note:  $R_{IN}$  is a 125mW resistor

For a switch input:  
Calculate the value of  $R_c$  from the above equation given switch voltage  $V_c$  and chosen current between 2 and 8 mA.

For 5V TTL Signal:  
Set  $R_c$  to be 680Ω or less.

**RoHS COMPLIANCE INFORMATION**



This series is compatible with RoHS soldering systems with a peak wave solder temperature of 260°C for 10 seconds. The pin termination finish on this product series is Tin Plate, Hot Dipped over Matte Tin with Nickel Preplate. The series is backward compatible with Sn/Pb soldering systems.

## TECHNICAL NOTES

### ISOLATION VOLTAGE

'Hi Pot Test', 'Flash Tested', 'Withstand Voltage', 'Proof Voltage', 'Dielectric Withstand Voltage' & 'Isolation Test Voltage' are all terms that relate to the same thing, a test voltage, applied for a specified time, across a component designed to provide electrical isolation, to verify the integrity of that isolation.

Murata Power Solutions NCS3 series of DC/DC converters are all 100% production tested at their stated isolation voltage. This is 1.5kVDC for 60 seconds.

A question commonly asked is, "What is the continuous voltage that can be applied across the part in normal operation?"

The NCS3 has been recognized by Underwriters Laboratory for functional isolation. Both input and output should normally be maintained within SELV limits i.e. less than 42.4V peak, or 60VDC. The isolation test voltage represents a measure of immunity to transient voltages and the part should never be used as an element of a safety isolation system. The part could be expected to function correctly with several hundred volts offset applied continuously across the isolation barrier; but then the circuitry on both sides of the barrier must be regarded as operating at an unsafe voltage and further isolation/insulation systems must form a barrier between these circuits and any user-accessible circuitry according to safety standard requirements.

### REPEATED HIGH-VOLTAGE ISOLATION TESTING

It is well known that repeated high-voltage isolation testing of a barrier component can actually degrade isolation capability, to a lesser or greater degree depending on materials, construction and environment. The NCS3 series has a toroid core, with no additional insulation between primary and secondary windings of enameled wire. While parts can be expected to withstand several times the stated test voltage, the isolation capability does depend on the wire insulation. Any material, including this enamel (typically polyurethane) is susceptible to eventual chemical degradation when subject to very high applied voltages thus implying that the number of tests should be strictly limited. We therefore strongly advise against repeated high voltage isolation testing, but if it is absolutely required, that the voltage be reduced by 20% from specified test voltage.

This consideration equally applies to agency recognized parts rated for better than functional isolation where the wire enamel insulation is always supplemented by a further insulation system of physical spacing or barriers.

## SAFETY APPROVAL

The NCS3 series has been recognized by Underwriters Laboratory (UL) to UL 60950 for functional insulation, file number E151252 applies. The NCS3 Series of converters are not internally fused so to meet the requirements of UL 60950 an anti-surge input line fuse should always be used with ratings as defined below.

NCS3S12XXSC: 0.75A

NCS3S48XXSC: 0.50A

All fuses should be UL approved and rated to at least the maximum allowable DC input voltage.

## CHARACTERISATION TEST METHODS

### Ripple & Noise Characterisation Method

Ripple and noise measurements are performed with the following test configuration.

C1	1µF X7R multilayer ceramic capacitor, voltage rating to be a minimum of 3 times the output voltage of the DC/DC converter
C2	10µF tantalum capacitor, voltage rating to be a minimum of 1.5 times the output voltage of the DC/DC converter with an ESR of less than 100mΩ at 100 kHz
C3	100nF multilayer ceramic capacitor, general purpose
R1	450Ω resistor, carbon film, ±1% tolerance
R2	50Ω BNC termination
T1	3T of the coax cable through a ferrite toroid
RLOAD	Resistive load to the maximum power rating of the DC/DC converter. Connections should be made via twisted wires

Measured values are multiplied by 10 to obtain the specified values.

### Differential Mode Noise Test Schematic

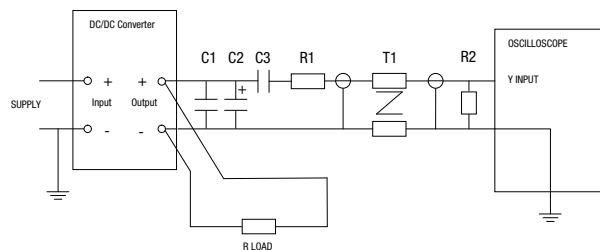

**EFFICIENCY VS LOAD**

**NCS3S1203SC**

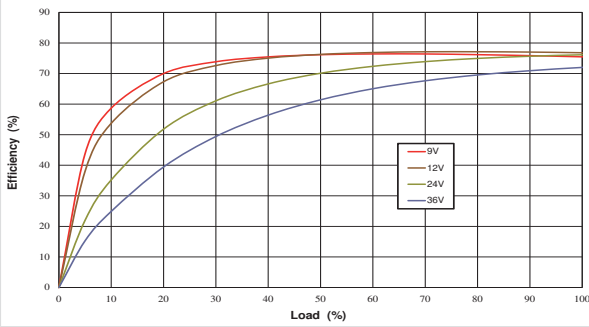

**NCS3S1205SC**

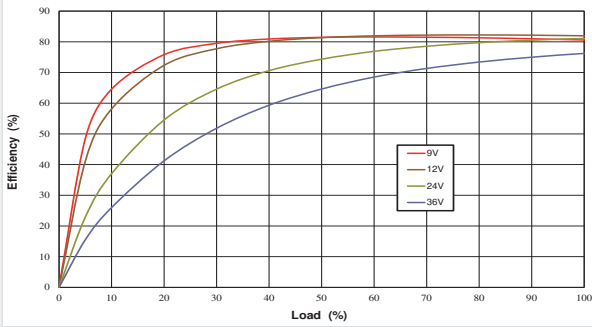

**NCS3S1212SC**

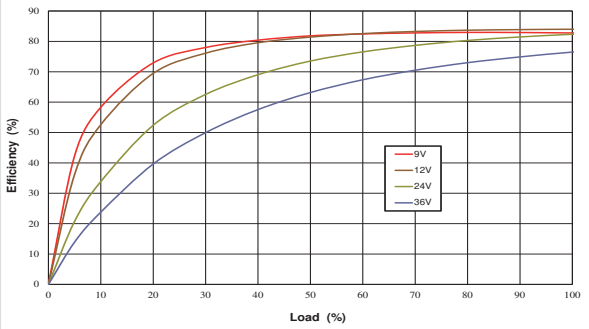

**NCS3S1215SC**

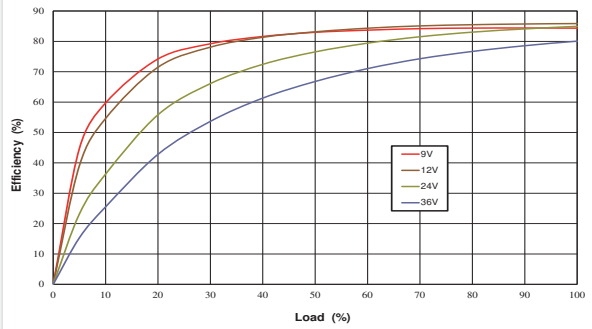

**NCS3S4803SC**

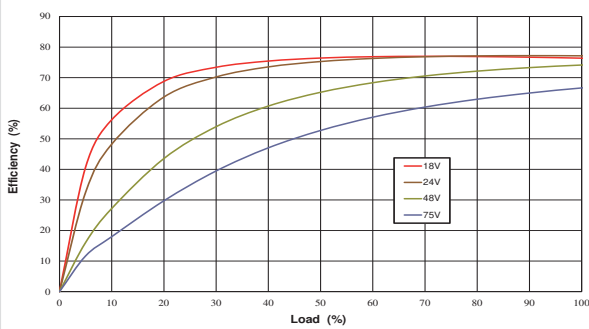

**NCS3S4805SC**

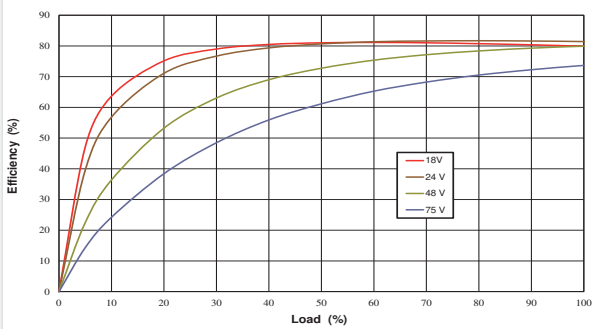

**NCS3S4812SC**

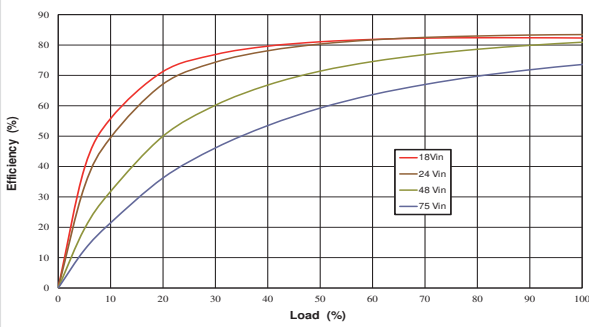

**NCS3S4815SC**

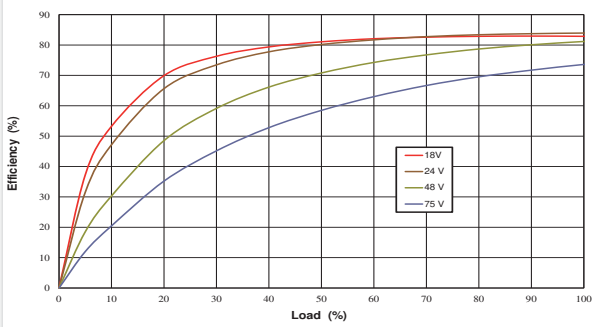

**TEMPERATURE DERATING**

**NCS3S1203SC**

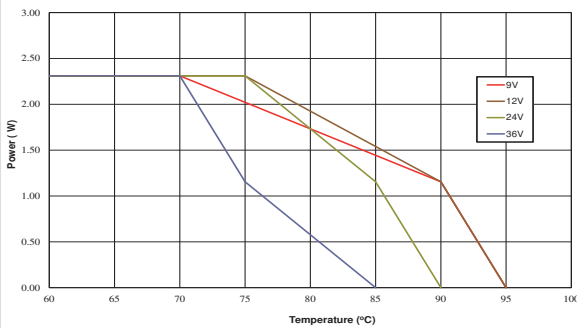

**NCS3S1205SC**

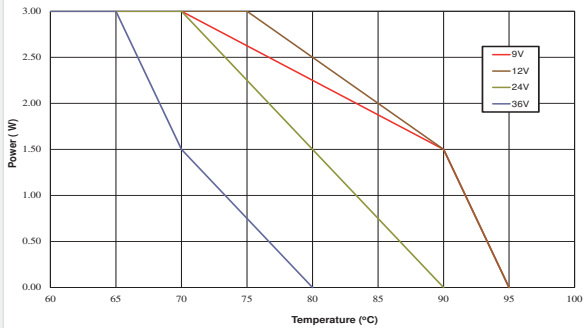

**NCS3S1212SC**

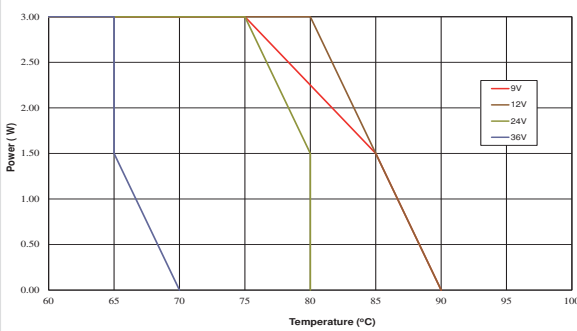

**NCS3S1215SC**

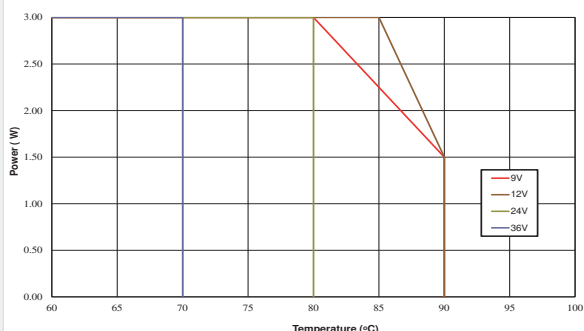

**NCS3S4803SC**

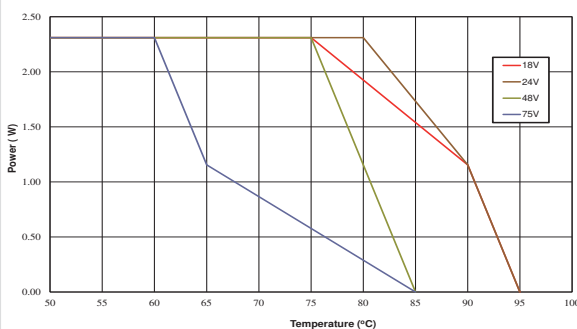

**NCS3S4805SC**

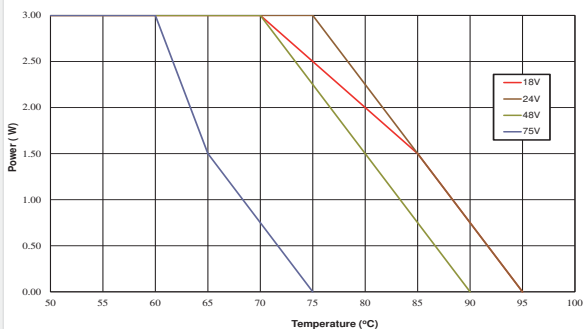

**NCS3S4812SC**

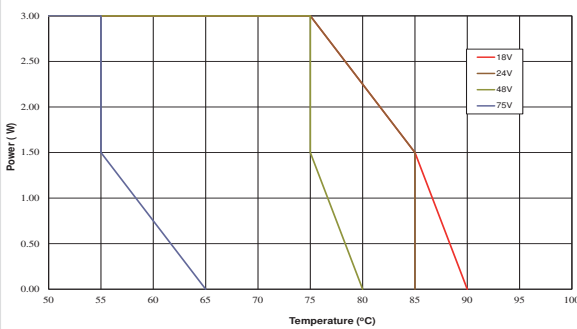

**NCS3S4815SC**

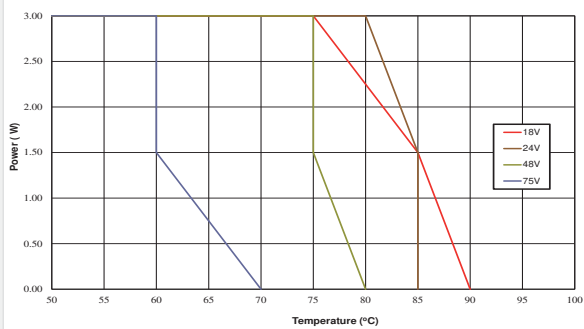

**EMC FILTERING AND SPECTRA**

**FILTERING**

The module includes a basic level of filtering, sufficient for many applications. Where lower noise levels are desired, filters can easily be added to achieve any required noise performance.

A DC/DC converter generates noise in two principal forms: that which is radiated from its body and that conducted on its external connections. There are three separate modes of conducted noise: input differential, output differential and input-output.

This last appears as common mode at the input and the output, and cannot therefore be removed by filtering at the input or output alone. The first level of filtering is to connect capacitors between input and output returns, to reduce this form of noise. It typically contains high harmonics of the switching frequency, which tend to appear as spikes on surrounding circuits. The voltage rating of this capacitor must match the required isolation voltage. (Due to the great variety in isolation voltage and required noise performance, this capacitor has not been included within the converter.)

Input ripple is a voltage developed across the internal Input decoupling capacitor. It is therefore measured with a defined supply source impedance. Although simple series inductance will provide filtering, on its own it can degrade the stability. A shunt capacitor is therefore recommended across the converter input terminals, so that it is fed from a low impedance.

If no filtering is required, the inductance of long supply wiring could also cause a problem, requiring an input decoupling capacitor for stability. An electrolytic will perform well in these situations. The input-output filtering is performed by the common-mode choke on the primary. This could be placed on the output, but would then degrade the regulation and produce less benefit for a given size, cost, and power loss.

Radiated noise is present in magnetic and electric forms. Thanks to the small size of these units, neither form of noise will be radiated "efficiently", so will not normally cause a problem. Any question of this kind usually better repays attention to conducted signals.

**EMC FILTER AND VALUES TO OBTAIN SPECTRA AS SHOWN**

The following filter circuit and filter table shows the input filters typically required to meet EN55022 Quasi-Peak Curve A or B.

**C1** Polyester or Ceramic capacitor

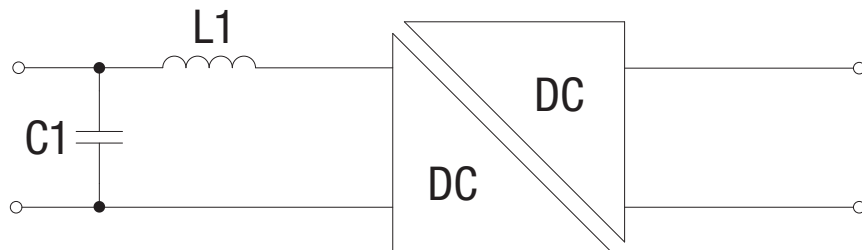

TO MEET CURVE A		
Part Number	C1	L1
NCS3S1203SC	2.2µF	3.3µH
NCS3S1205SC	2.2µF	3.3µH
NCS3S1212SC	1.5µF	3.3µH
NCS3S1215SC	1.5µF	3.3µH
NCS3S4803SC	4.7µF	3.3µH
NCS3S4805SC	4.7µF	3.3µH
NCS3S4812SC	4.7µF	3.3µH
NCS3S4815SC	4.7µF	3.3µH

TO MEET CURVE B		
Part Number	C1	L1
NCS3S1203SC	4.7µF	15µH
NCS3S1205SC	4.7µF	10µH
NCS3S1212SC	4.7µF	10µH
NCS3S1215SC	4.7µF	10µH
NCS3S4803SC	9.4µF	50µH
NCS3S4805SC	9.4µF	50µH
NCS3S4812SC	9.4µF	50µH
NCS3S4815SC	9.4µF	50µH

The following typical spectra are shown for class A and class B respectively with quasi peak and mean value limits.



**EMC FILTERING AND SPECTRA CONTINUED**

**NCS3S1203SC**

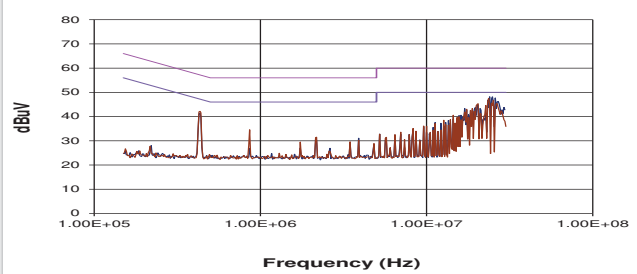
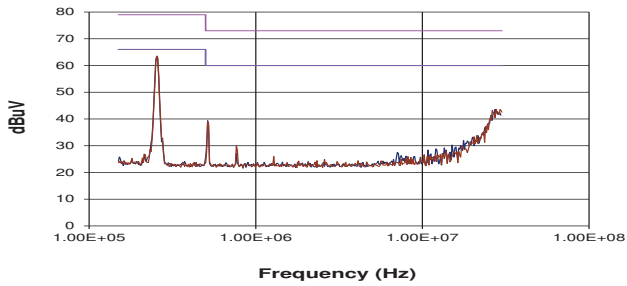

**NCS3S1205SC**

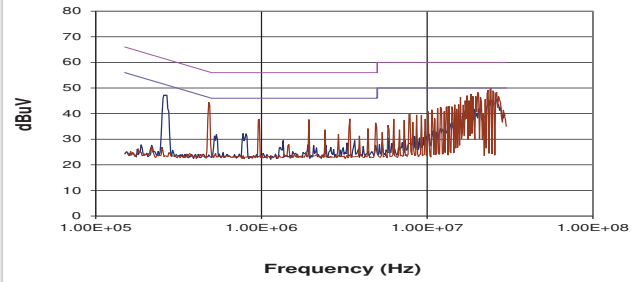
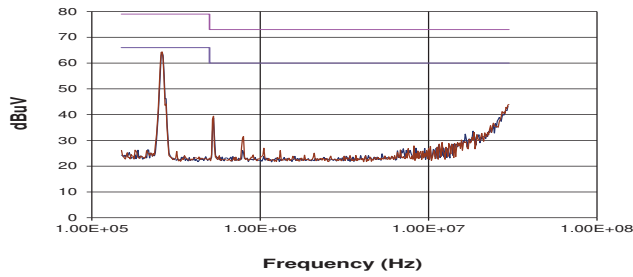

**NCS3S1212SC**

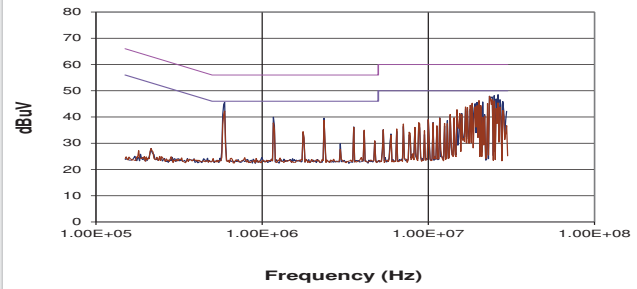
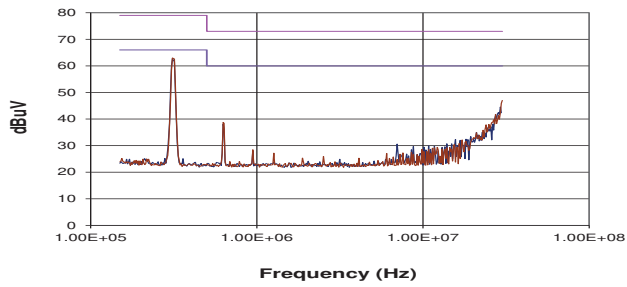

**NCS3S1215SC**

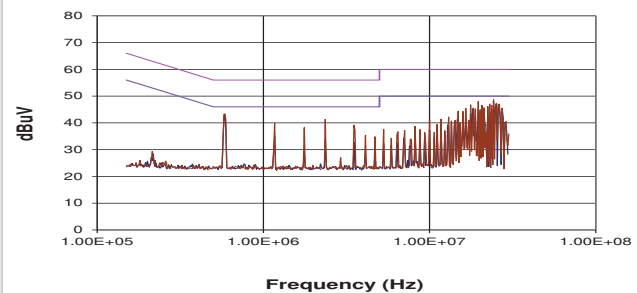
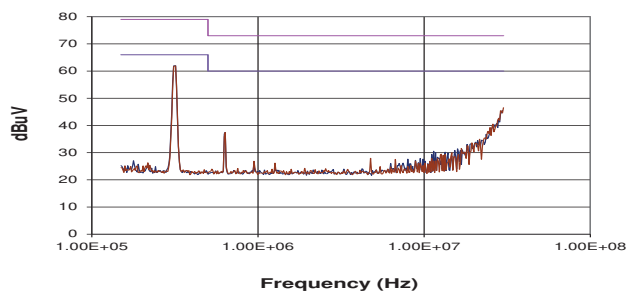

**EMC FILTERING AND SPECTRA CONTINUED**

**NCS3S4803SC**

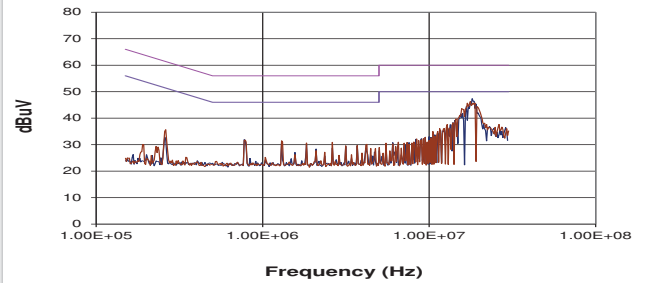
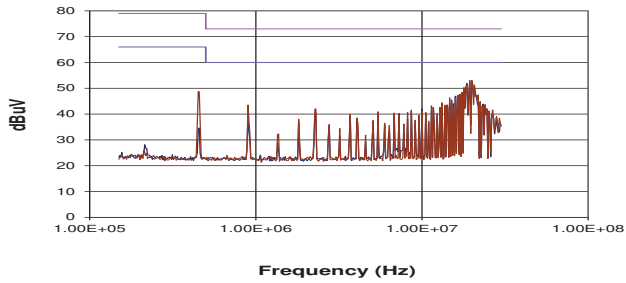

**NCS3S4805SC**

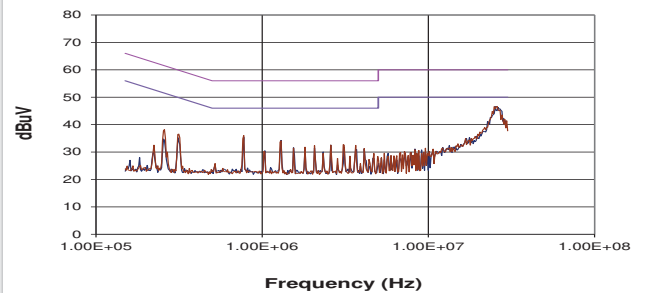
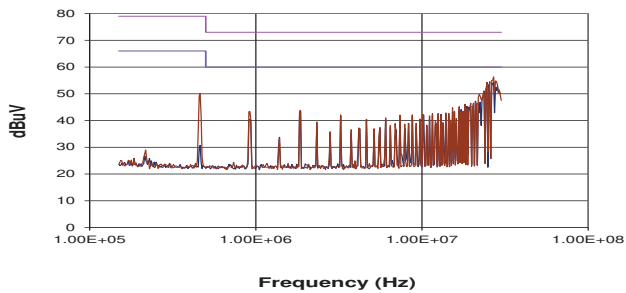

**NCS3S4812SC**

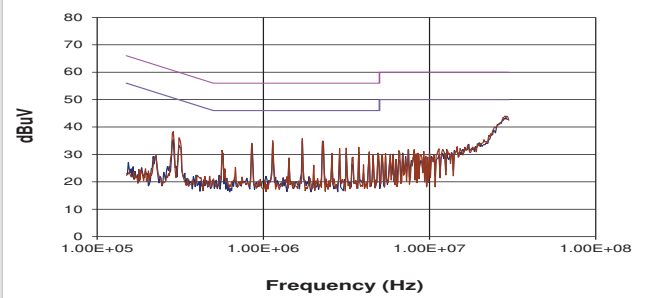
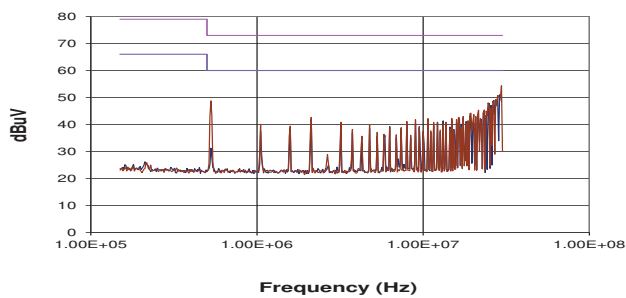

**NCS3S4815SC**

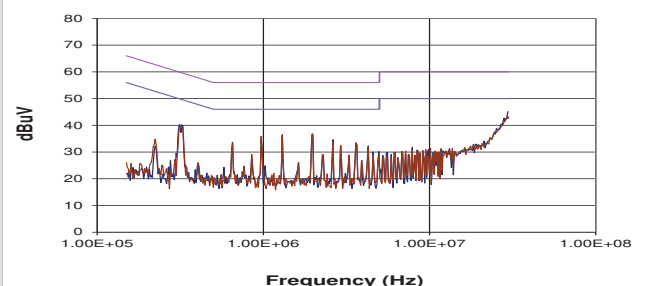
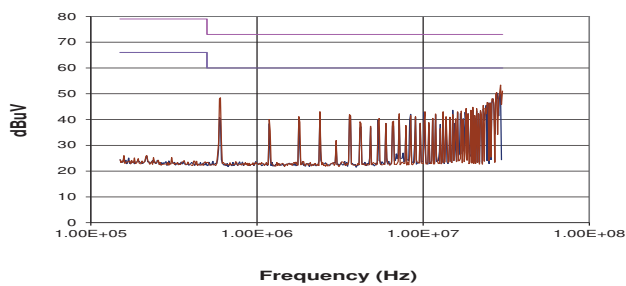

**PACKAGE SPECIFICATIONS**

**MECHANICAL DIMENSIONS**

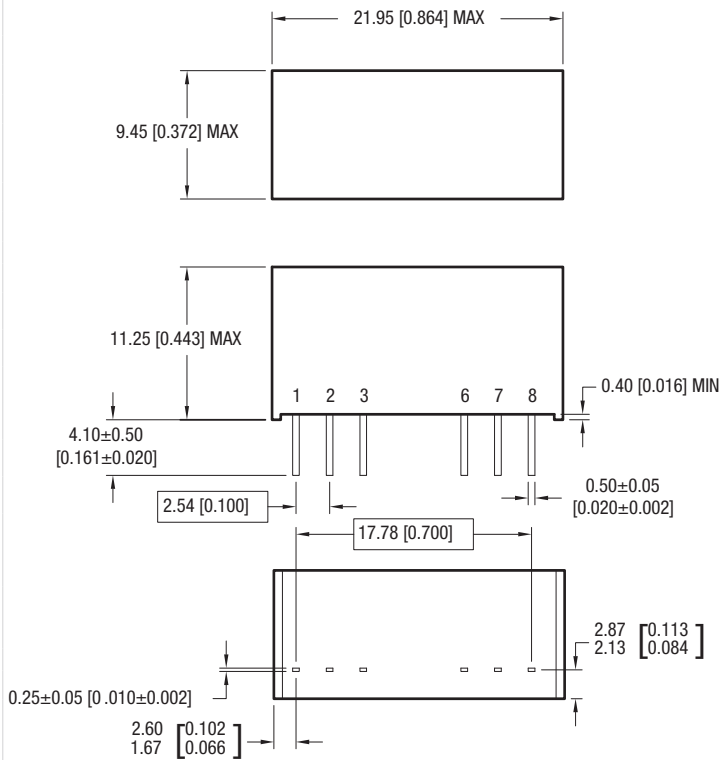

All dimensions in millimetres (inches) ± 0.5 (0.020) except pin to pin tolerance ±0.25 (0.010).  
All pins on a 2.54 (0.100) pitch and within 0.25 (0.010) of true position.

Weight: 4.4g

**PIN CONNECTIONS**

Pin	Function Single
1	-V <sub>IN</sub>
2	+V <sub>IN</sub>
3	Control
6	+V <sub>OUT</sub>
7	OV
8	N/C

**TUBE OUTLINE DIMENSIONS**

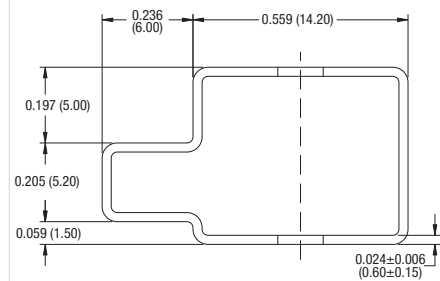

All dimensions in inches ±0.01 (mm ±0.5mm).  
Tube length : 20.47±0.079 (520mm ±2mm).

Tube Quantity : 23

**RECOMMENDED FOOTPRINT DETAILS**

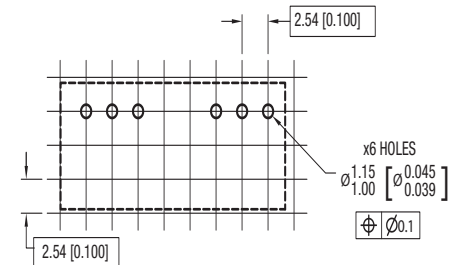

All dimensions in mm (inches) ±0.25 (± 0.010).

Murata Power Solutions, Inc.  
11 Cabot Boulevard, Mansfield, MA 02048-1151 U.S.A.  
ISO 9001 and 14001 REGISTERED



This product is subject to the following **operating requirements** and the **Life and Safety Critical Application Sales Policy**:  
Refer to: <http://www.murata-ps.com/requirements/>

Murata Power Solutions, Inc. makes no representation that the use of its products in the circuits described herein, or the use of other technical information contained herein, will not infringe upon existing or future patent rights. The descriptions contained herein do not imply the granting of licenses to make, use, or sell equipment constructed in accordance therewith. Specifications are subject to change without notice.  
© 2016 Murata Power Solutions, Inc.