



Chipsmall Limited consists of a professional team with an average of over 10 year of expertise in the distribution of electronic components. Based in Hongkong, we have already established firm and mutual-benefit business relationships with customers from,Europe,America and south Asia,supplying obsolete and hard-to-find components to meet their specific needs.

With the principle of “Quality Parts,Customers Priority,Honest Operation,and Considerate Service”,our business mainly focus on the distribution of electronic components. Line cards we deal with include Microchip,ALPS,ROHM,Xilinx,Pulse,ON,Everlight and Freescale. Main products comprise IC,Modules,Potentiometer,IC Socket,Relay,Connector.Our parts cover such applications as commercial,industrial, and automotives areas.

We are looking forward to setting up business relationship with you and hope to provide you with the best service and solution. Let us make a better world for our industry!



Contact us

Tel: +86-755-8981 8866 Fax: +86-755-8427 6832

Email & Skype: info@chipsmall.com Web: www.chipsmall.com

Address: A1208, Overseas Decoration Building, #122 Zhenhua RD., Futian, Shenzhen, China

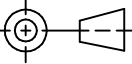

PAGE #	TITLE	REV. #	DATE
1	INDEX	A	10/16/02
2	RATINGS, RELIABILITY, OPERATING	A	10/16/02
3	DIMENSIONS	A	10/16/02
LOAD CHARACTERISTICS DATA			
4	NDL-102	A	10/16/02
5	NDL-104	A	10/16/02
6	NDL-106	A	10/16/02
7	NDL-206	A	10/16/02
8	NDL-208	A	10/16/02
9	NDL-210	A	10/16/02
10	NDL-212	A	10/16/02
11	NDL-217	A	10/16/02
12	NDL-201	A	10/16/02
13	NDL-202	A	10/16/02
14	NDL-203	A	10/16/02
15	NDL-204	A	10/16/02
16	NDL-205	A	10/16/02

		METRIC		DIMENSIONS ARE IN MILLIMETERS		JKL COMPONENTS CORPORATION						
				TOLERANCE UNLESS OTHERWISE SPECIFIED		TITLE						
		THIRD ANGLE PROJECTION		1 PL +/- REF. 2 PL +/- ANGLE +/-		NDL LOAD CHARACTERISTICS DATA						
		DRAWN BY		APPV'D BY DATE		SIZE	FSCM NO.	DRAWING NO.		NDL SERIES		
		L. WENGSTROM		F.D. 10/16/02		A	55335					
A		RELEASED		10/16/02		- CAD DRAWING -		SCALE	RELEASED DATE	REVISION DATE	REV. NO. A	SHEET 1 OF 16
		DESCRIPTION/ECONUMBER		APPV'D DATE		MANUAL REVISIONS NOT PERMITTED		NONE	10/16/02			

MAXIMUM RATINGS

ITEMS	MAXIMUM RATINGS	OPERATING RANGE
Input voltage	6 V dc	3.0 to 5.5 V dc
Operating temperature	-10 to 50°	
Storage temperature	-20 to 70°	

RELIABILITY TEST ITEMS

ITEMS	CONDITIONS	NOTES
Temperature shock	-20/70°C for 1 hour each, 10 cycles	1, 2, 3
Soldering heat resistance	260°C 10 seconds	1, 2, 3
Lead strength	1KG 10 seconds	1, 2, 3
Vibration	Frequency = 10 to 55 Hz, amplitude = 1.5mm (1 hour for each direction of X, Y, Z) sweep time = 1 minute/cycle	1, 2, 3

NOTES: 1. The changed values of input current, output voltage and output frequency must be within 10% of their initial values.
2. No significant change or abnormality in external appearance must occur.
3. Dimensions must conform to specifications.

RELIABILITY TEST ITEMS

PART NUMBER	RECOMMENDED ELEMENT AREA (cm ²)	NOMINAL VALUE			
		LOAD AREA (cm ²)	BRIGHTNESS (cd/m ²)	FREQUENCY (Hz)	OUTPUT VOLTAGE (Vrms)
NDL-102	20 to 30	25			
NDL-104	25 to 40	33			
NDL-106	40 to 80	60			
NDL-206	40 to 100	70	80 to 100	500 to 600	80 to 120
NDL-208	60 to 140	90			
NDL-210	70 to 100	85			
NDL-212	80 to 120	100			
NDL-217	100 to 170	135			
NDL-201	10 to 19	15	40 to 60	450 to 550	70 to 90
NDL-202	19 to 38	28			
NDL-203	25 to 43	34			
NDL-204	41 to 70	56			
NDL-205	50 to 83	66			

NDL-102, NDL-104

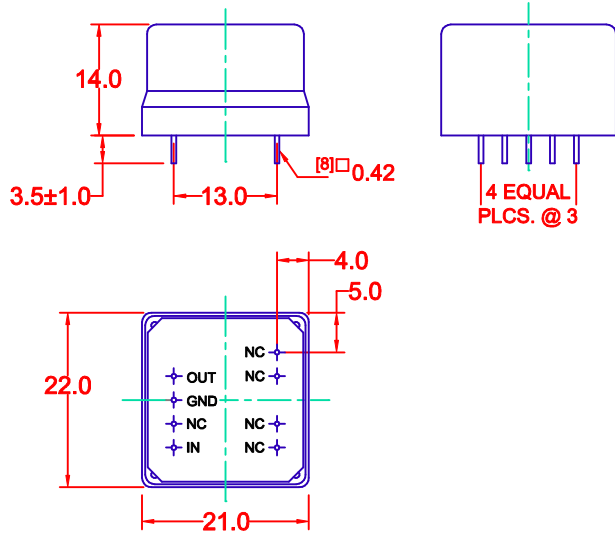

NDL-106

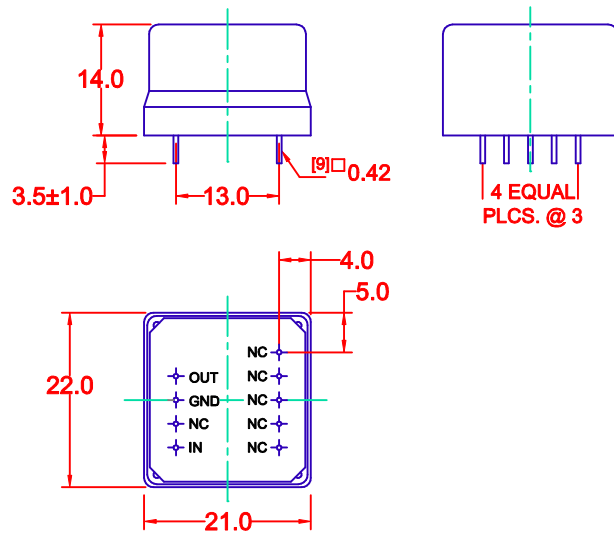

NDL-206, NDL-208, NDL-210, NDL-212

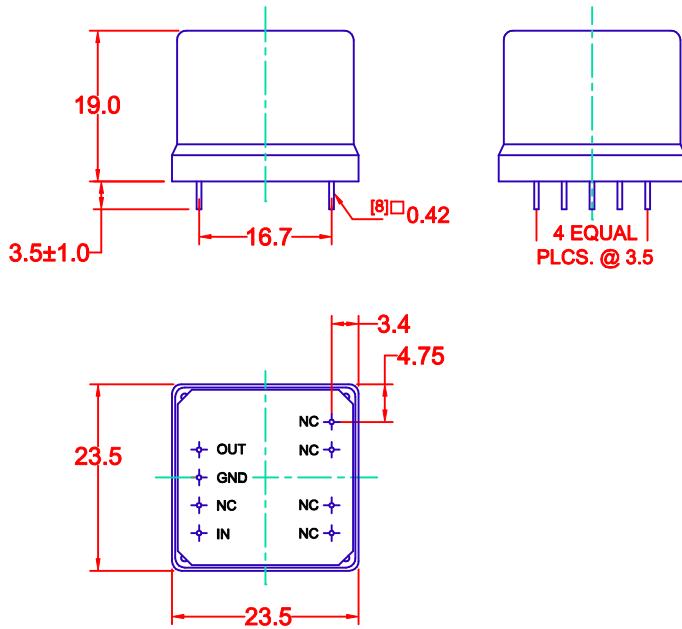

NDL-217

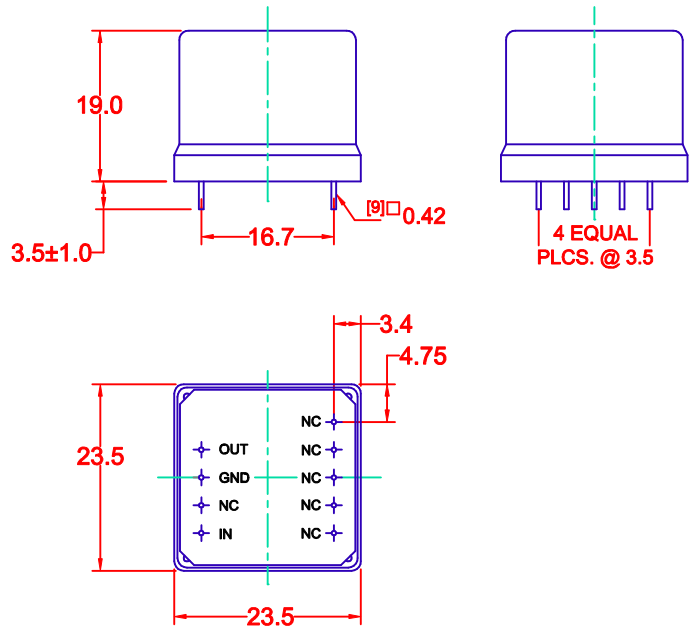

NDL-201 TO 205

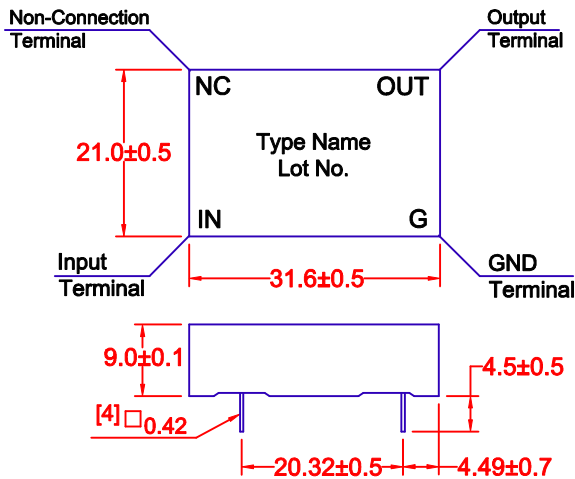

**P.C.B. DRILLING
ON ALL SERIES
Ø1.07mm (0.042")
PTH AFTER PLATING**

LOAD CHARACTERISTICS DATA

INVERTER: NDL-102

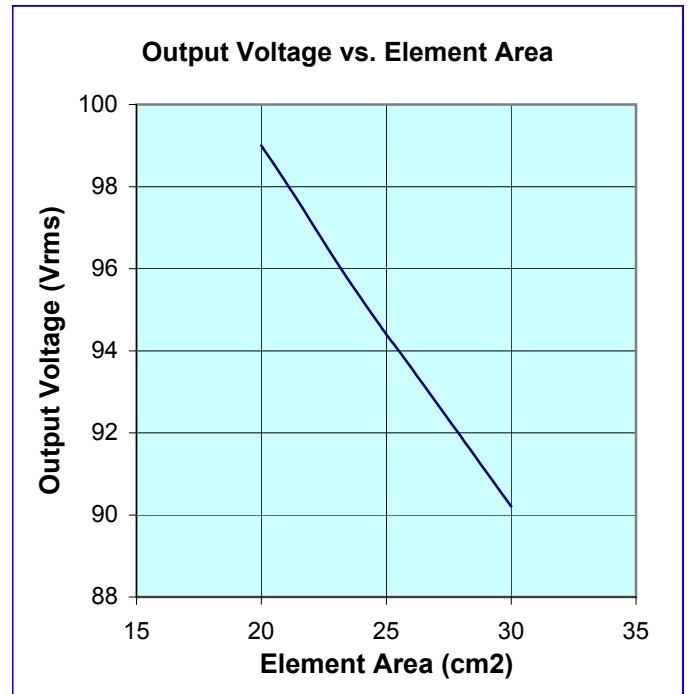
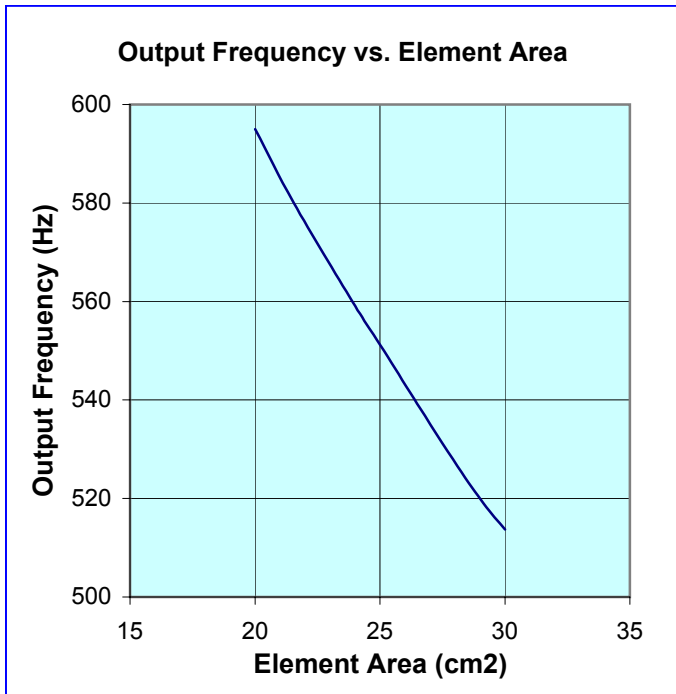
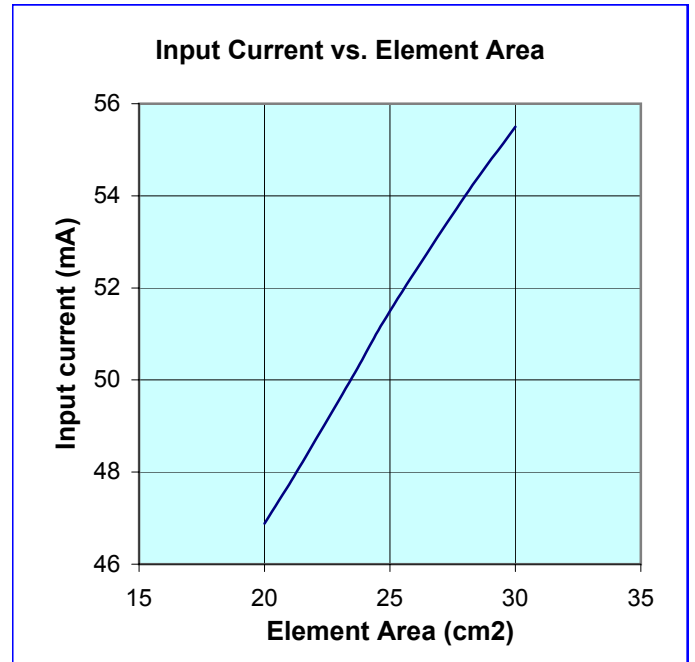
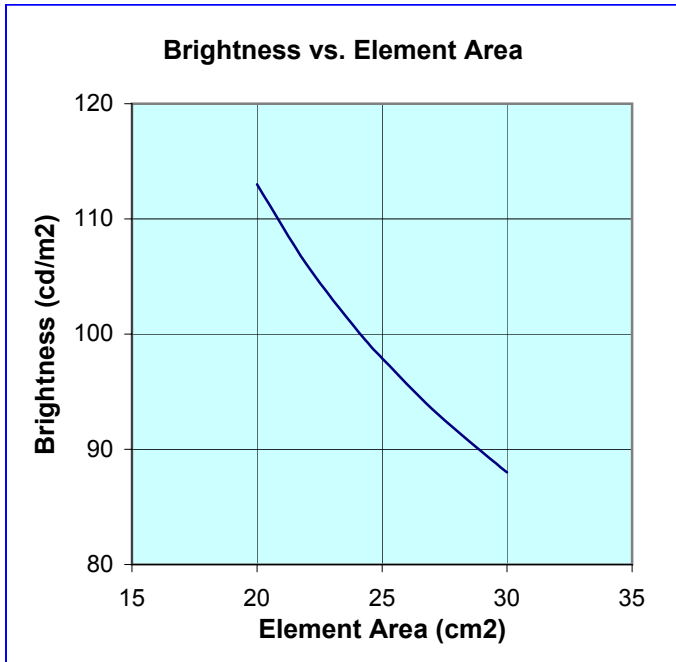

LOAD CHARACTERISTICS DATA

INVERTER: NDL-104

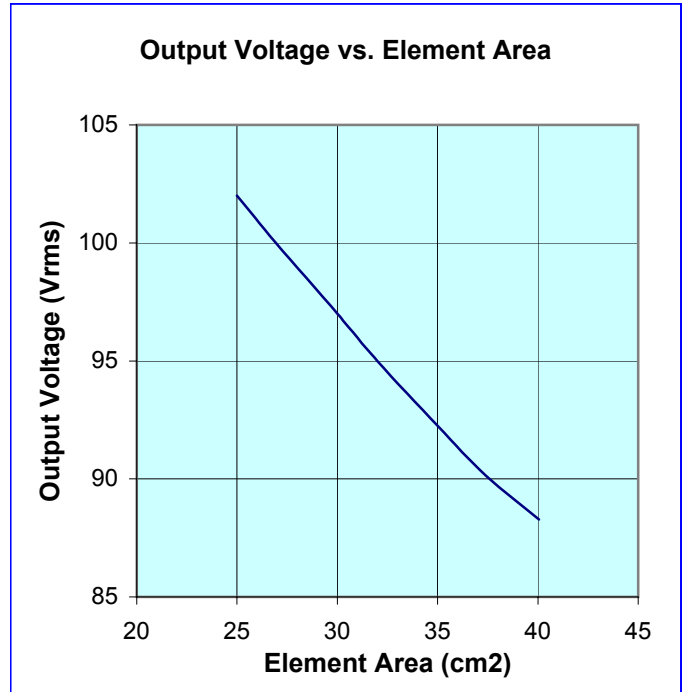
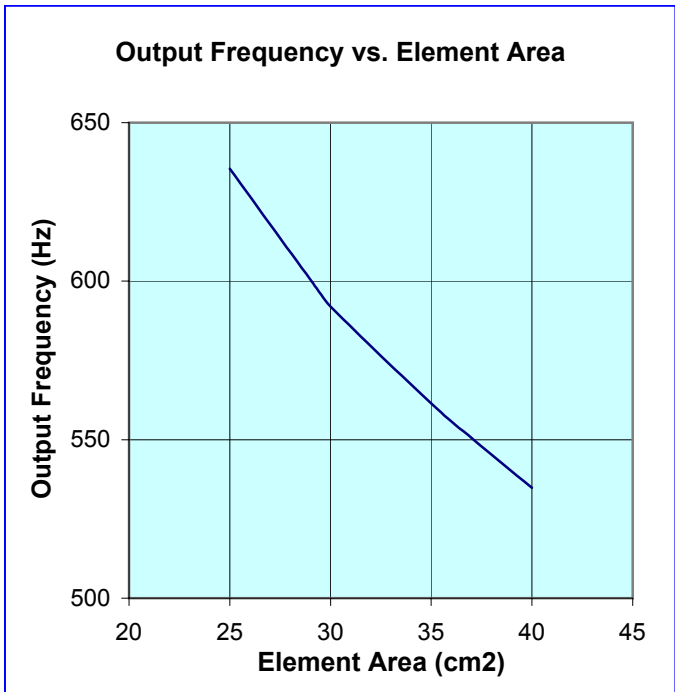
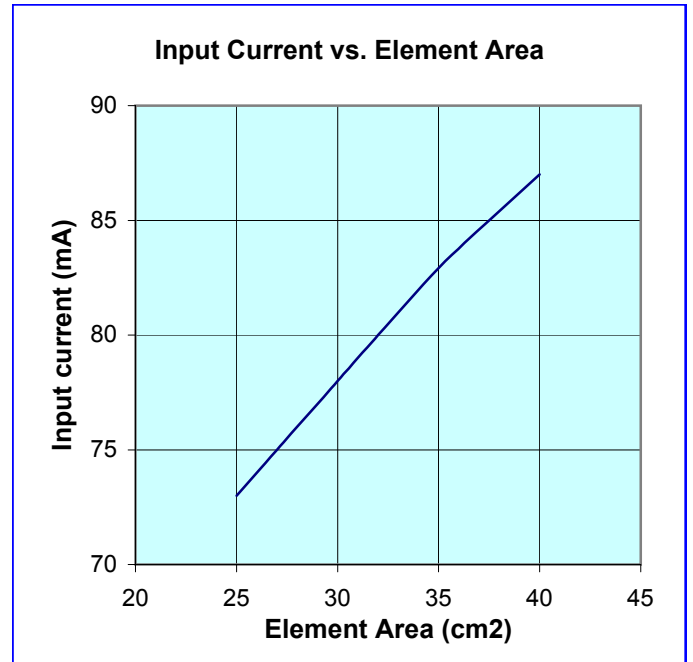
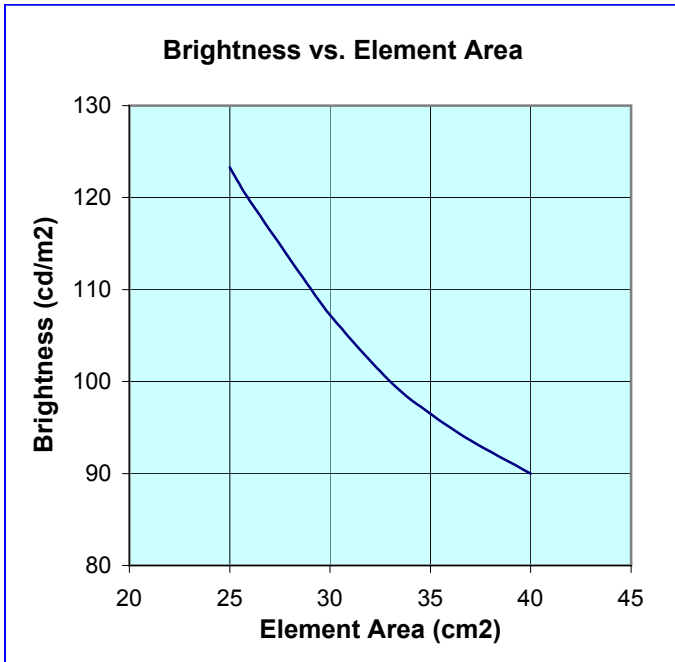

LOAD CHARACTERISTICS DATA

INVERTER: NDL-106

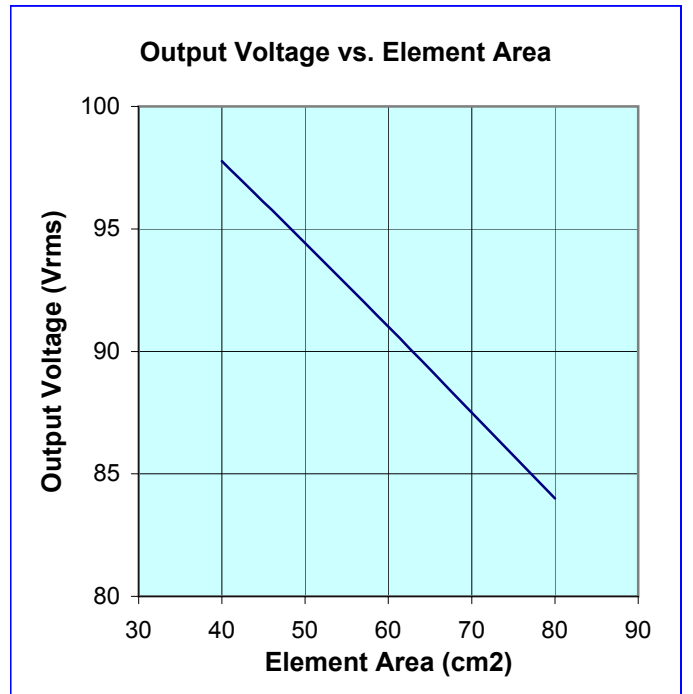
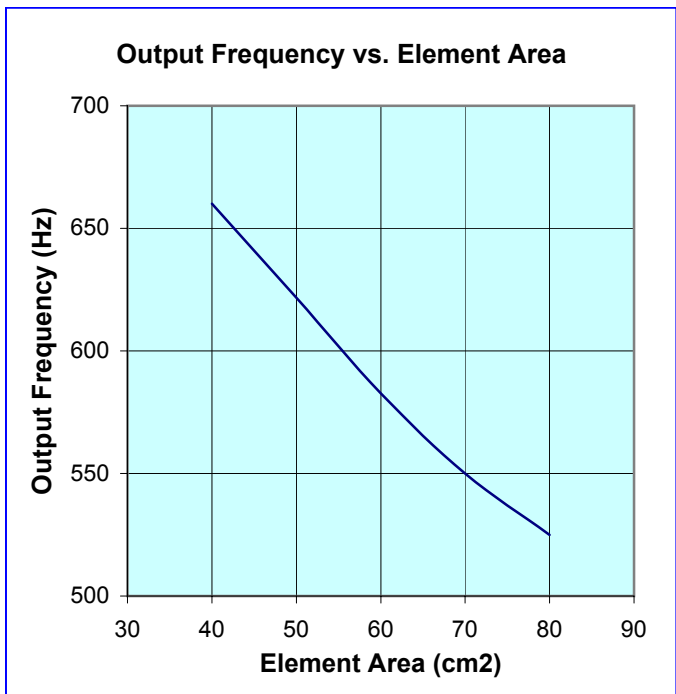
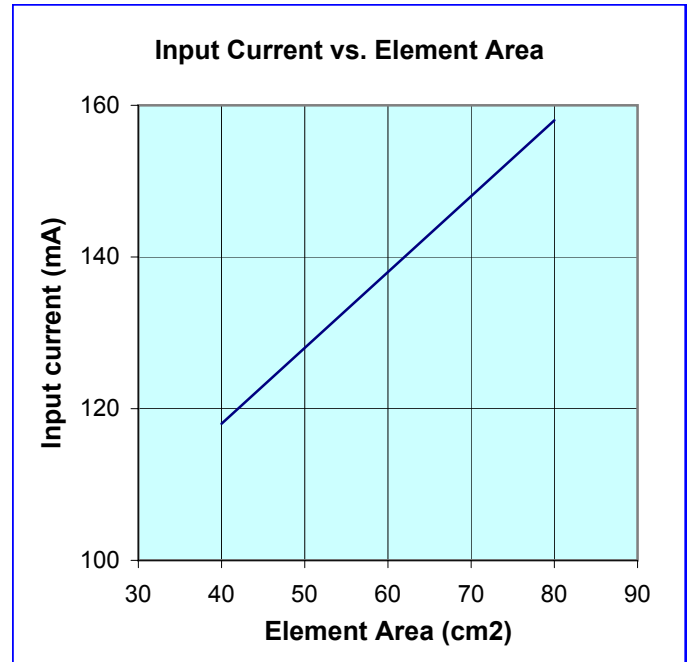
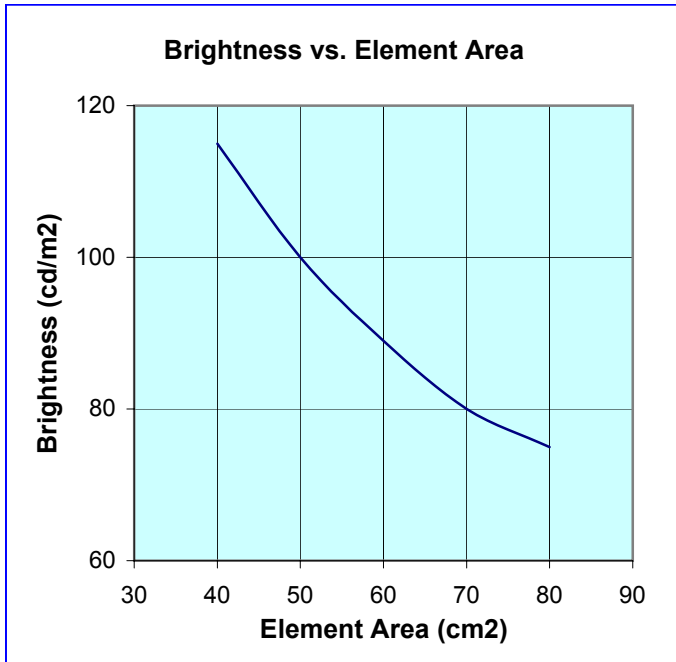

LOAD CHARACTERISTICS DATA

INVERTER: NDL-206

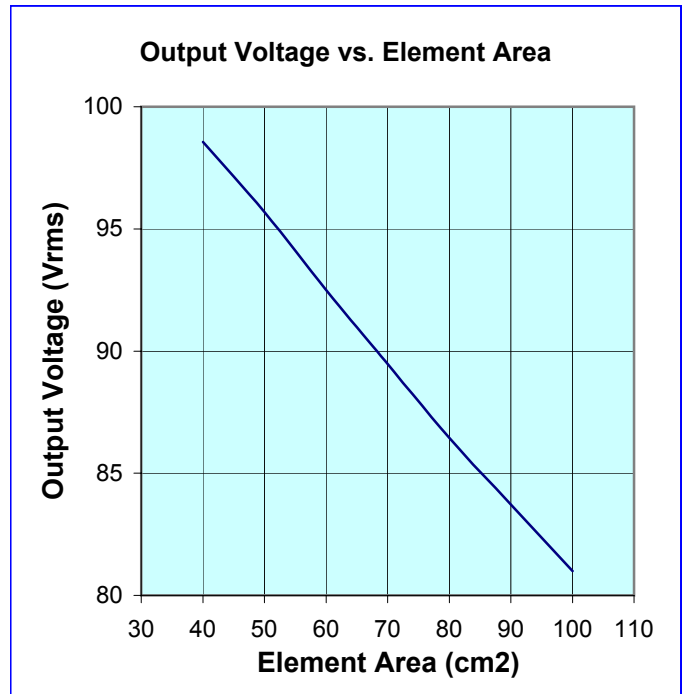
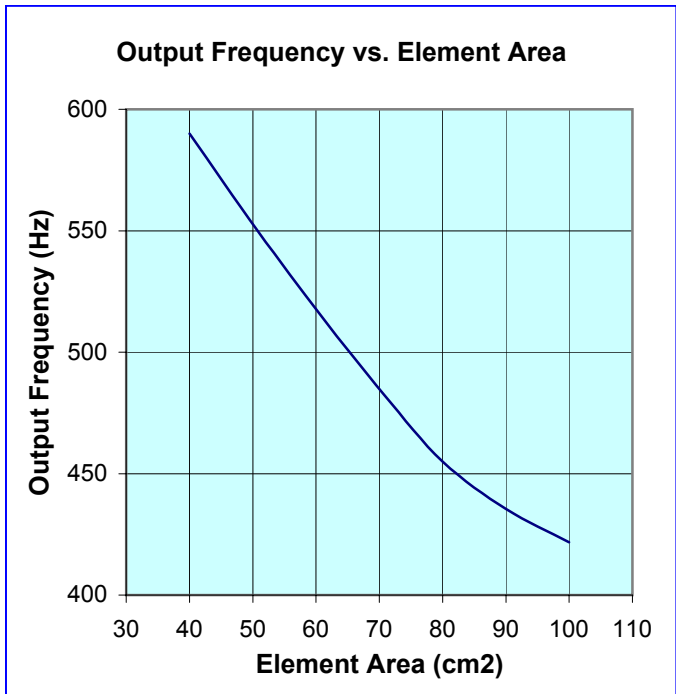
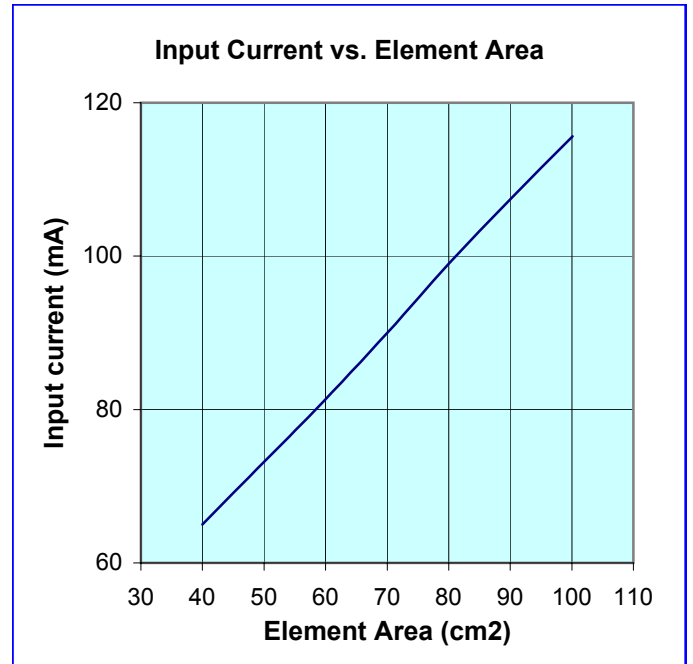
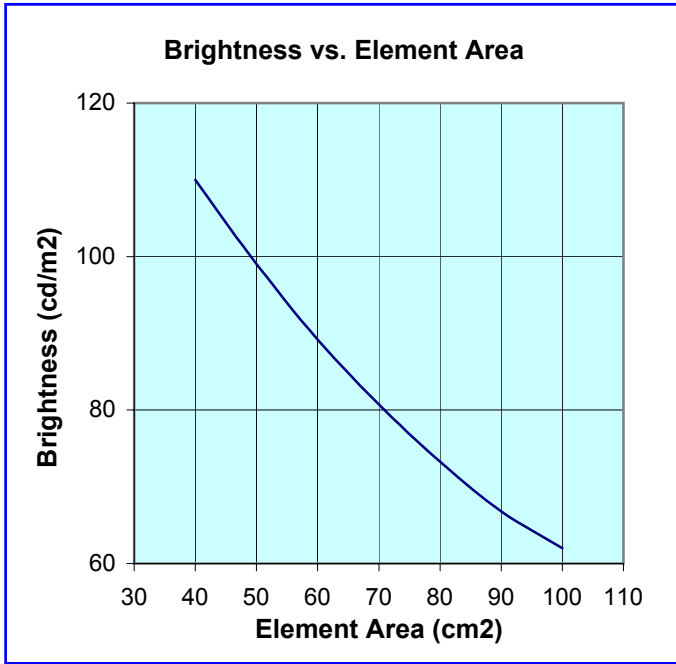

LOAD CHARACTERISTICS DATA

INVERTER: NDL-208

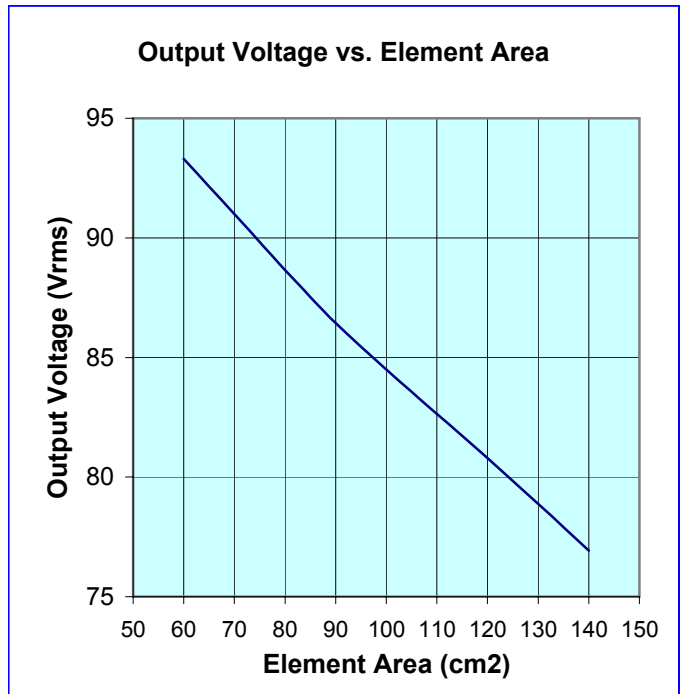
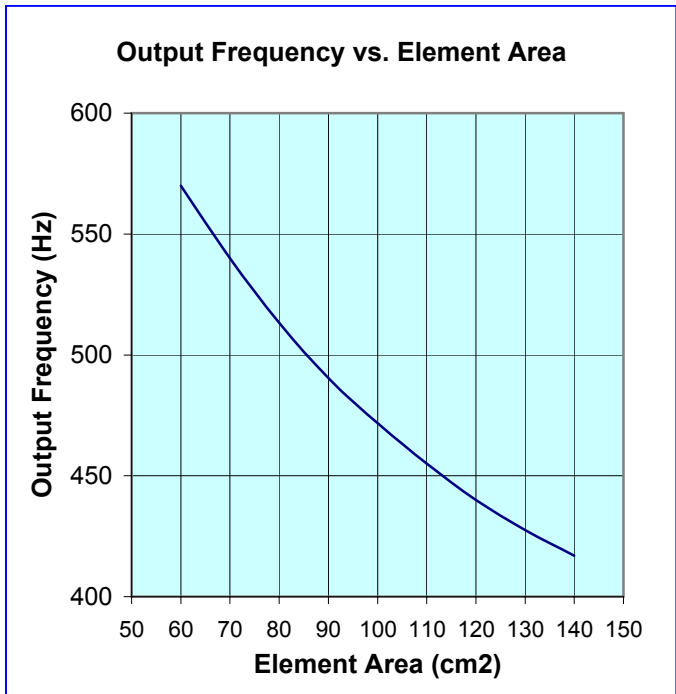
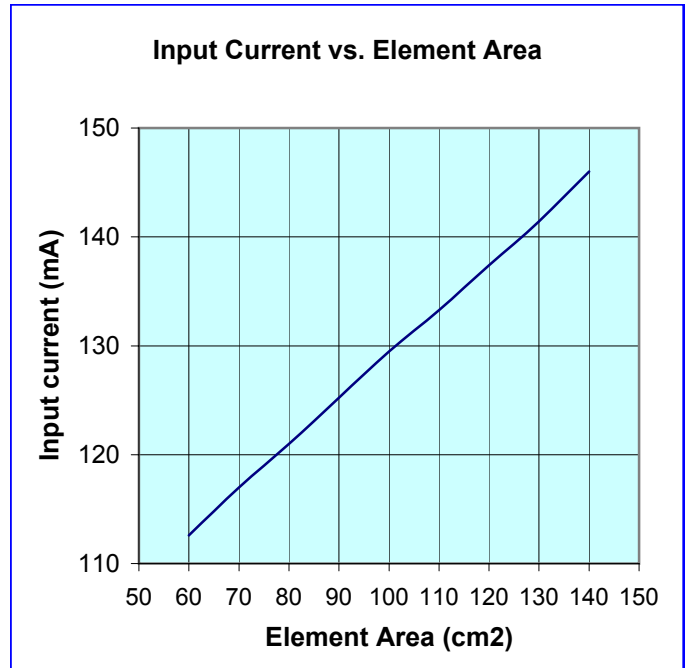
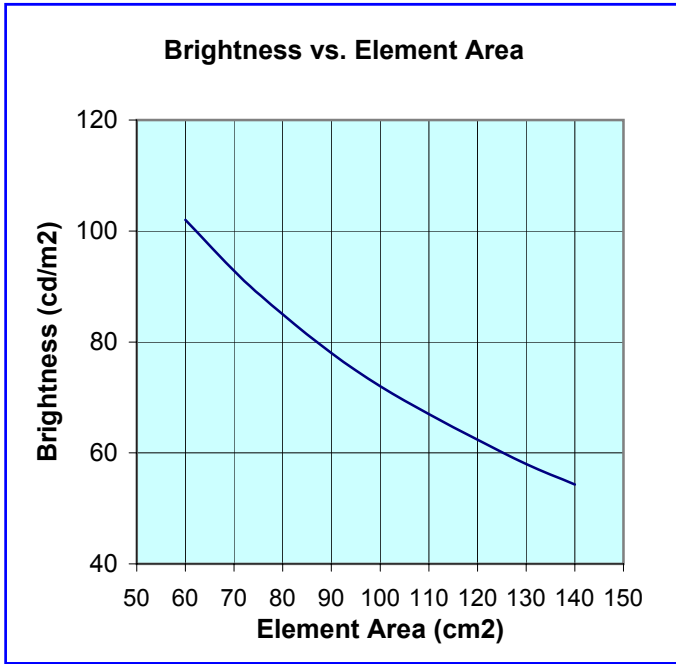

LOAD CHARACTERISTICS DATA

INVERTER: NDL-210

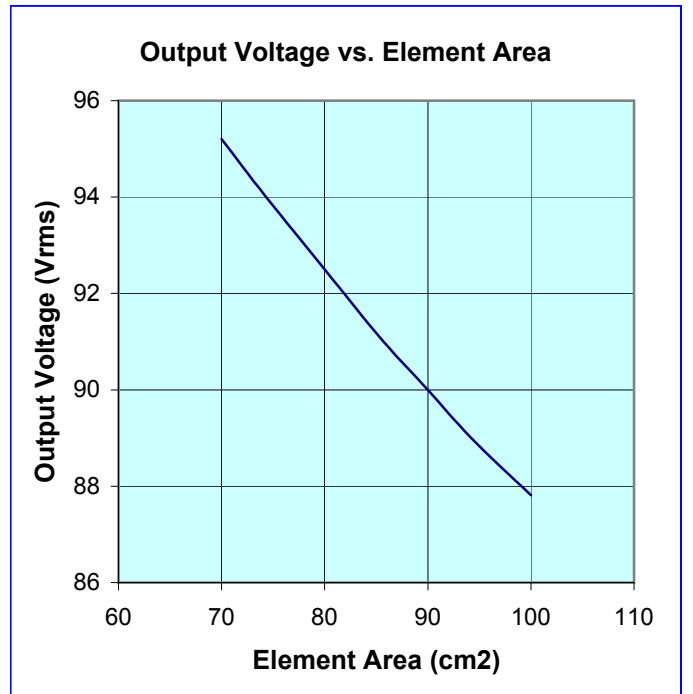
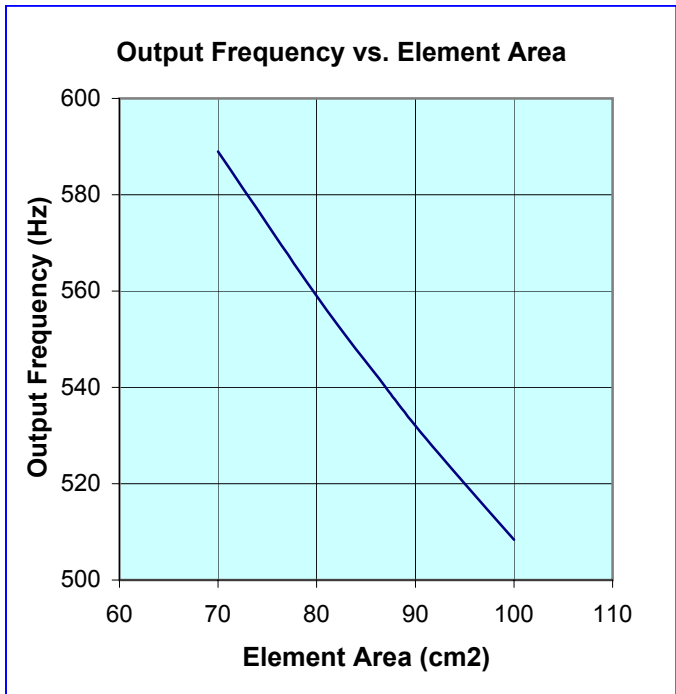
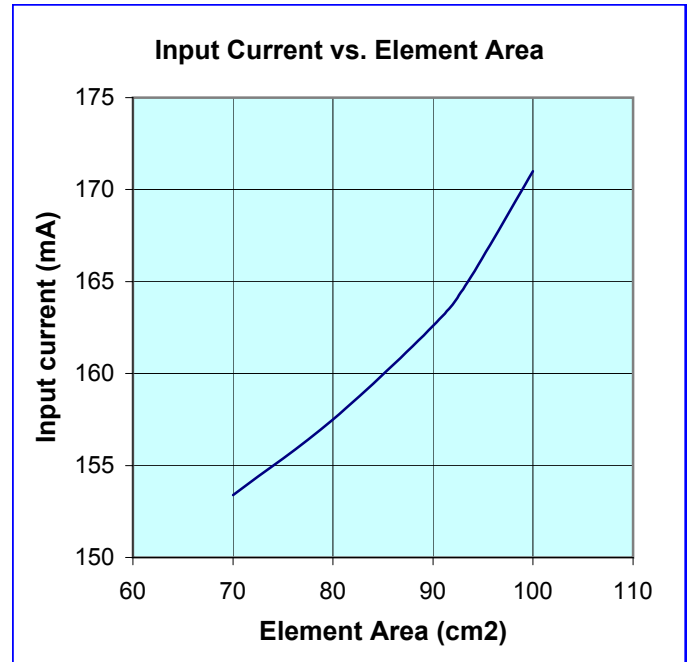
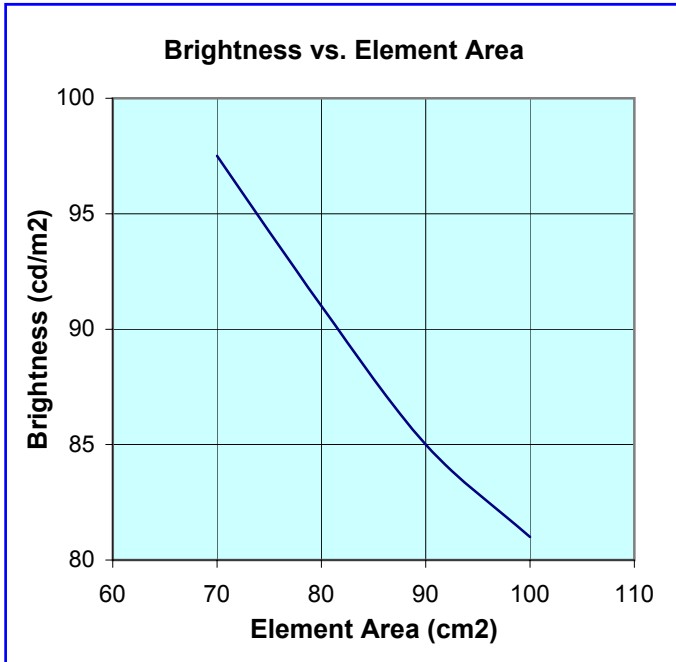

LOAD CHARACTERISTICS DATA

INVERTER: NDL-212

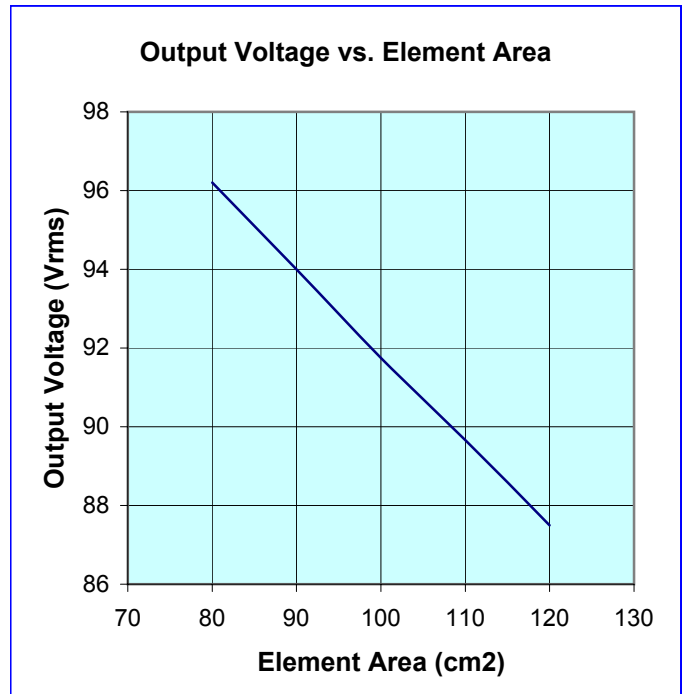
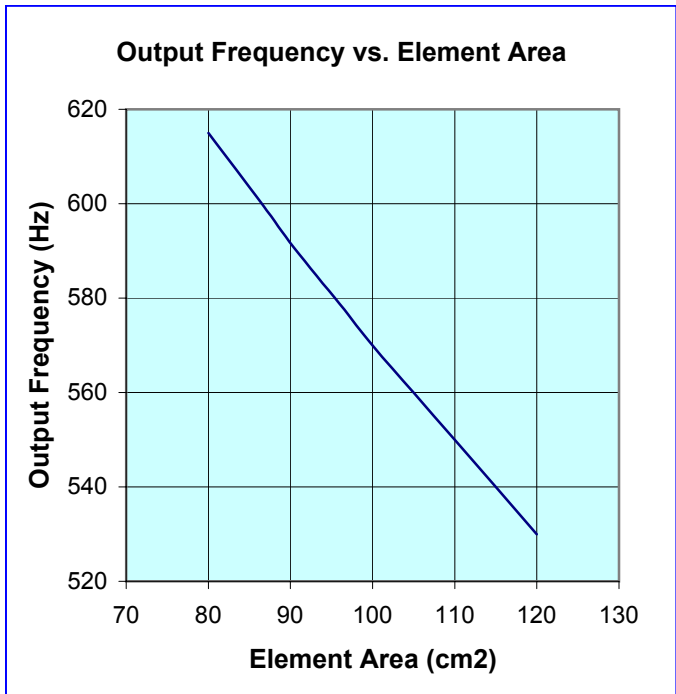
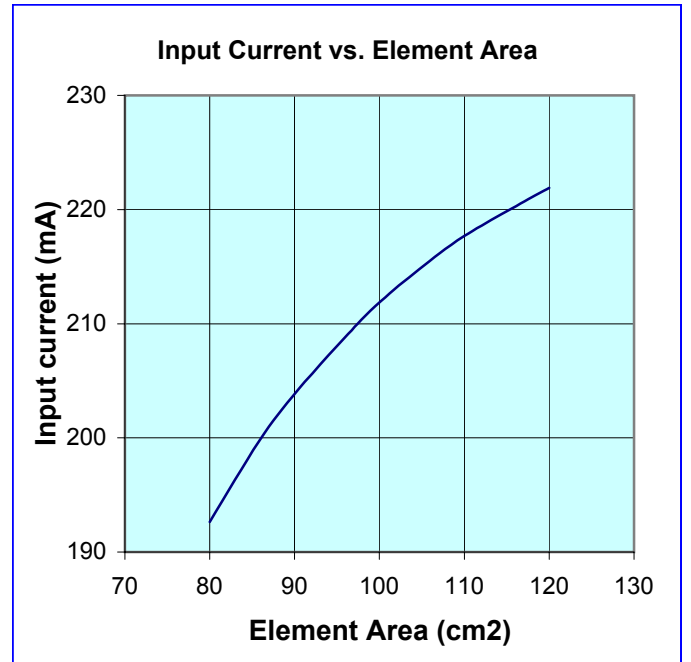
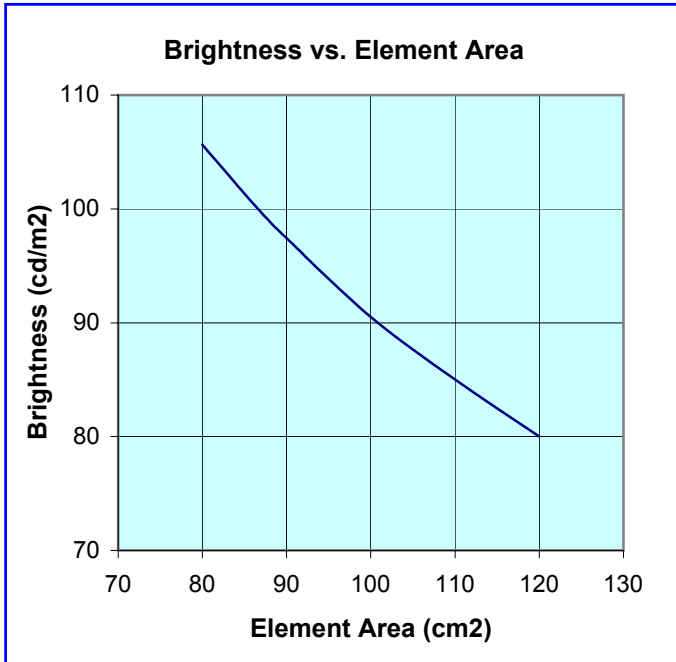

LOAD CHARACTERISTICS DATA

INVERTER: NDL-217

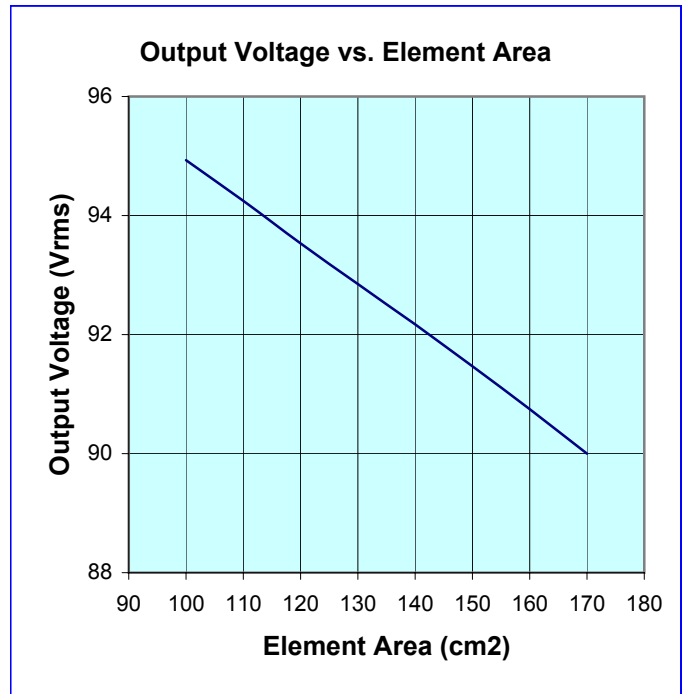
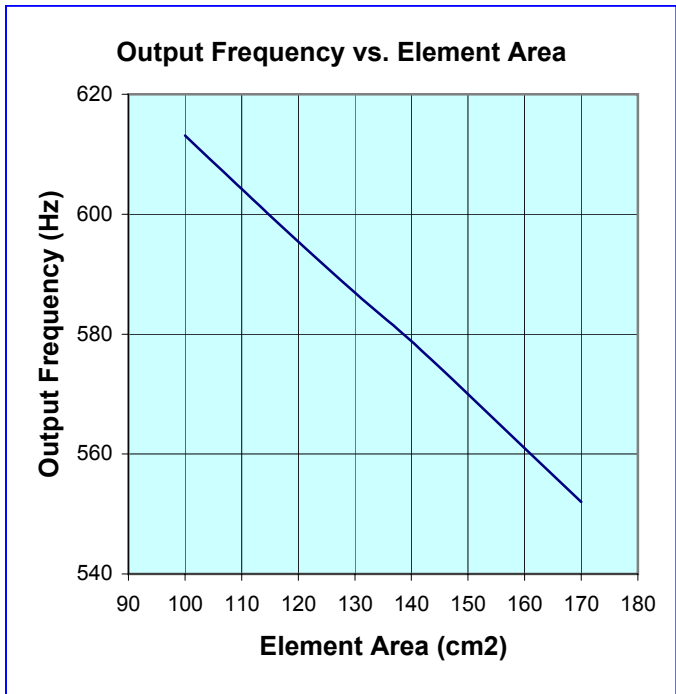
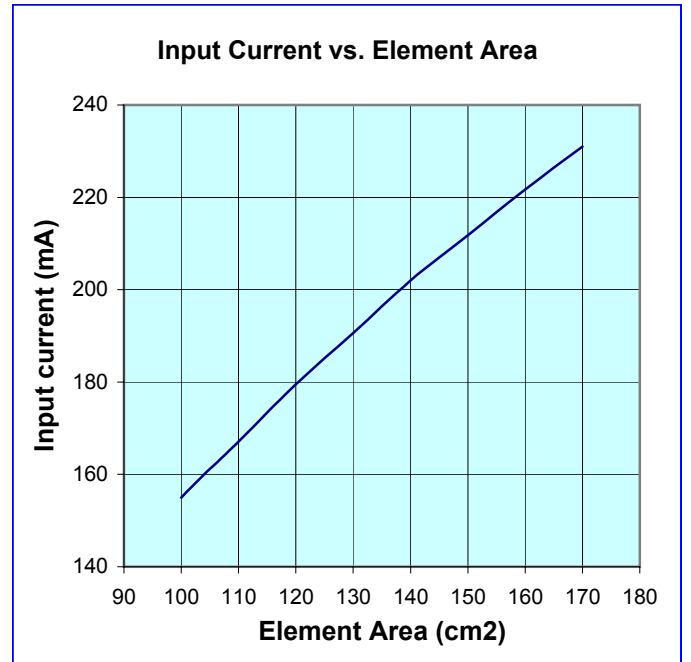
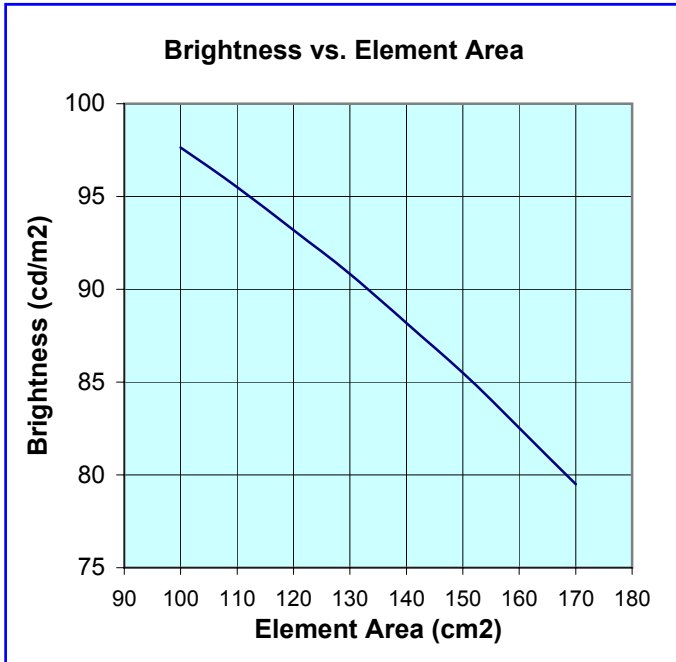

LOAD CHARACTERISTICS DATA

INVERTER: NDL-201

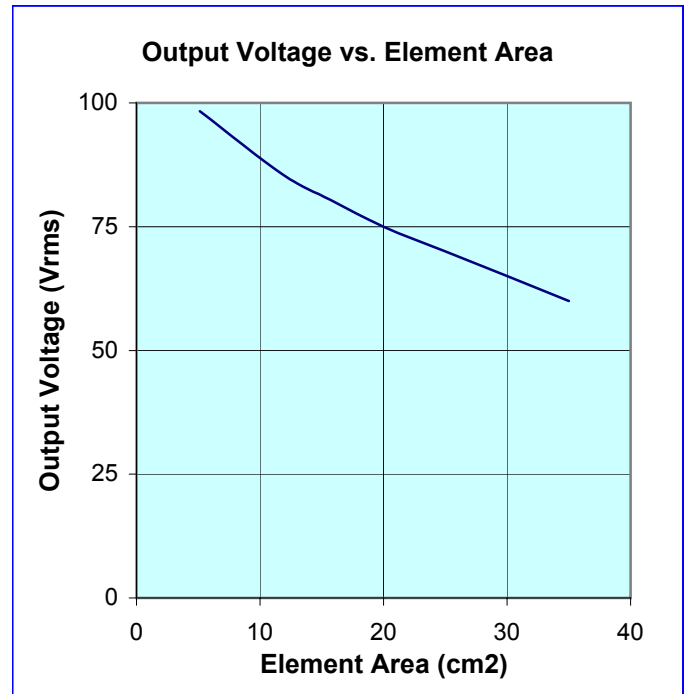
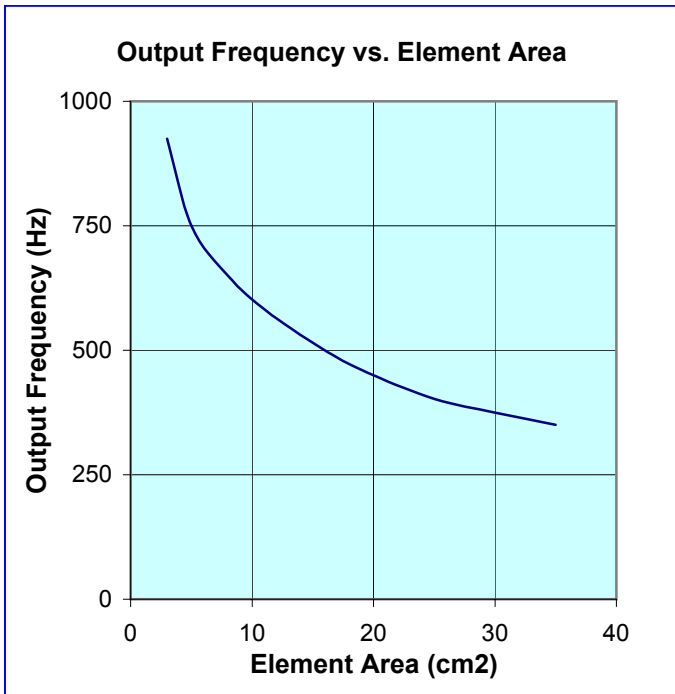
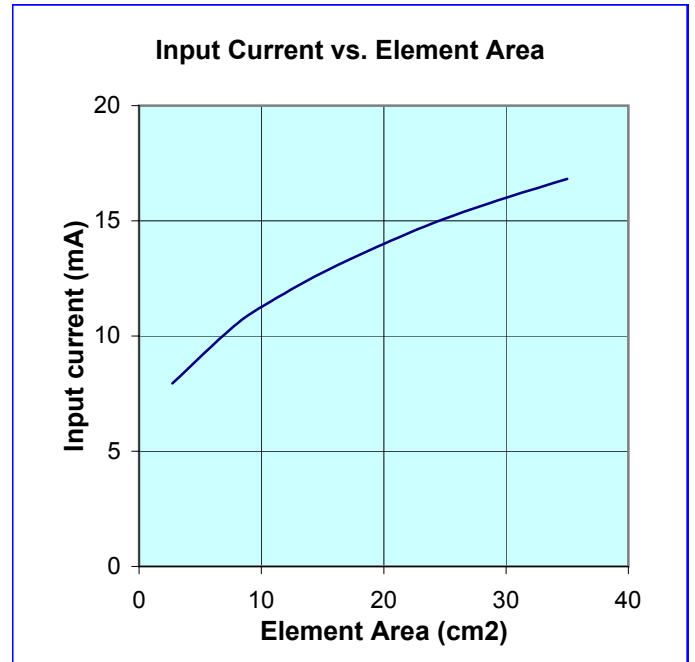
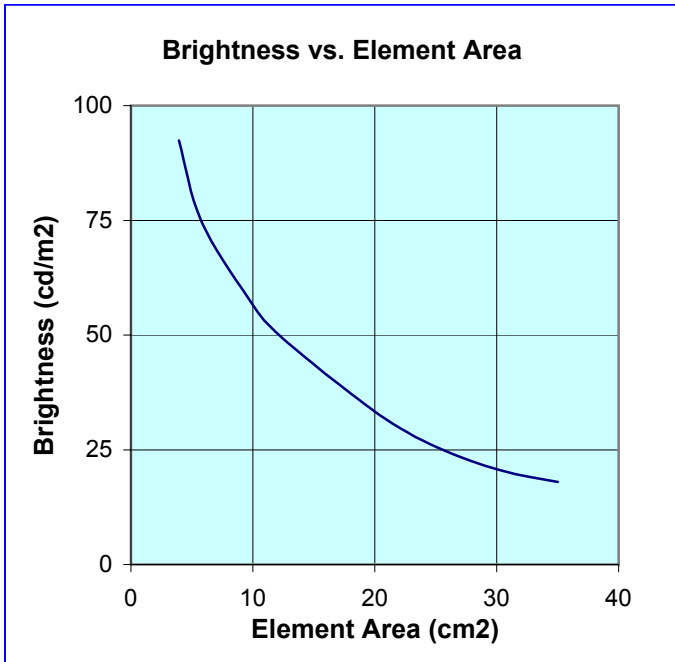

LOAD CHARACTERISTICS DATA

INVERTER: NDL-202

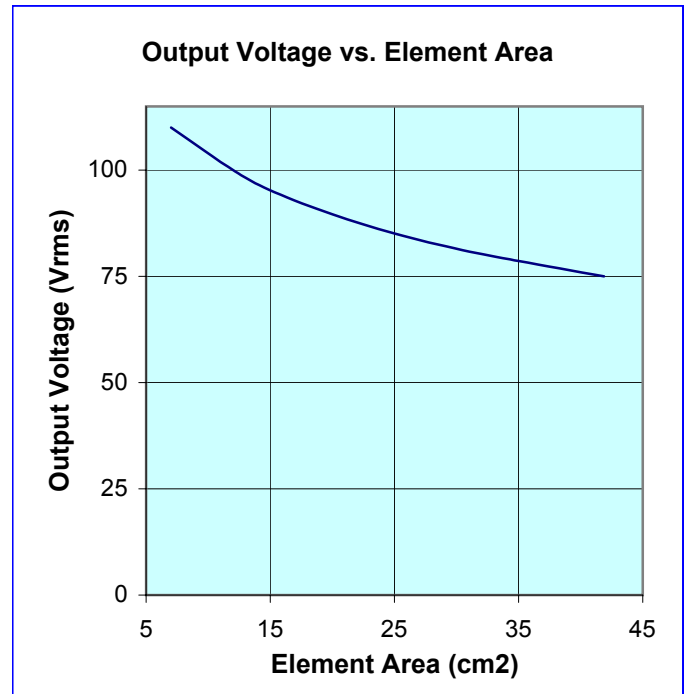
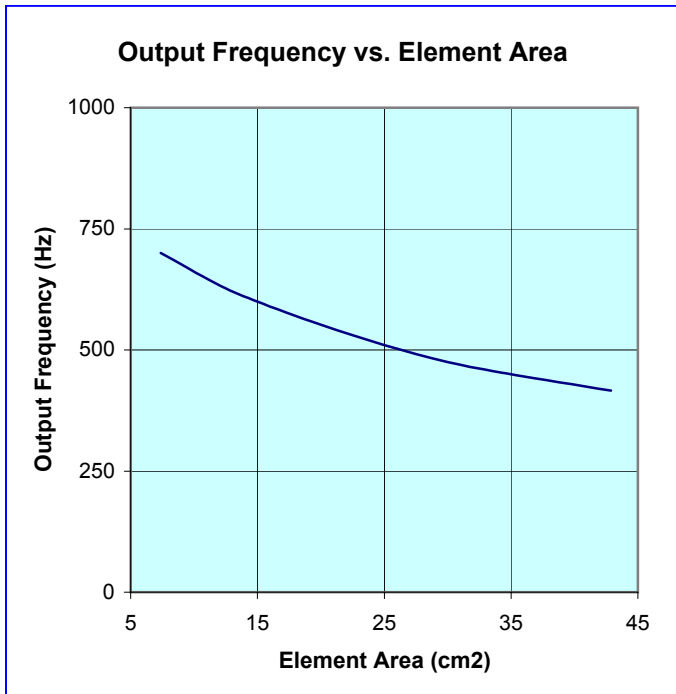
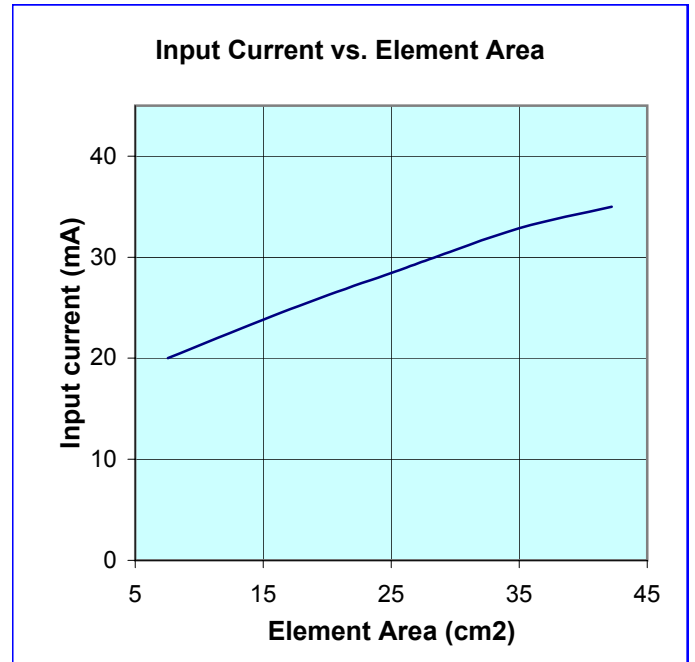
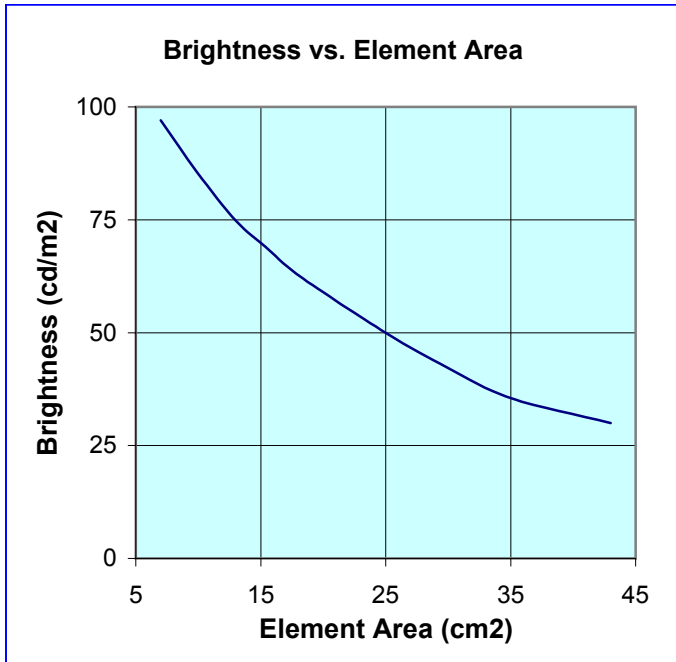

LOAD CHARACTERISTICS DATA

INVERTER: NDL-203

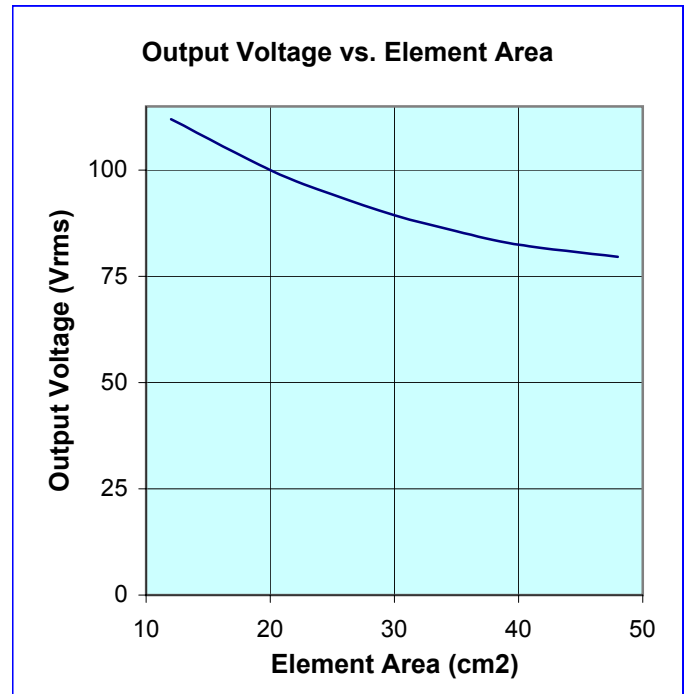
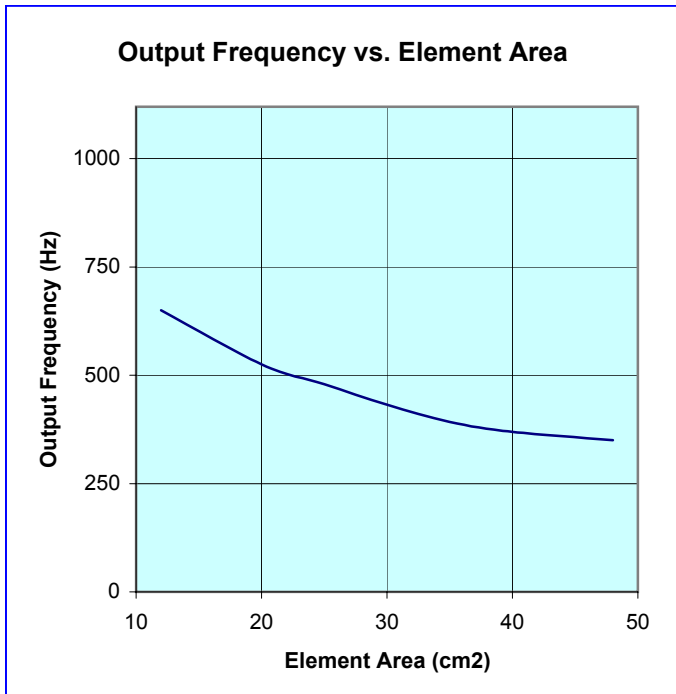
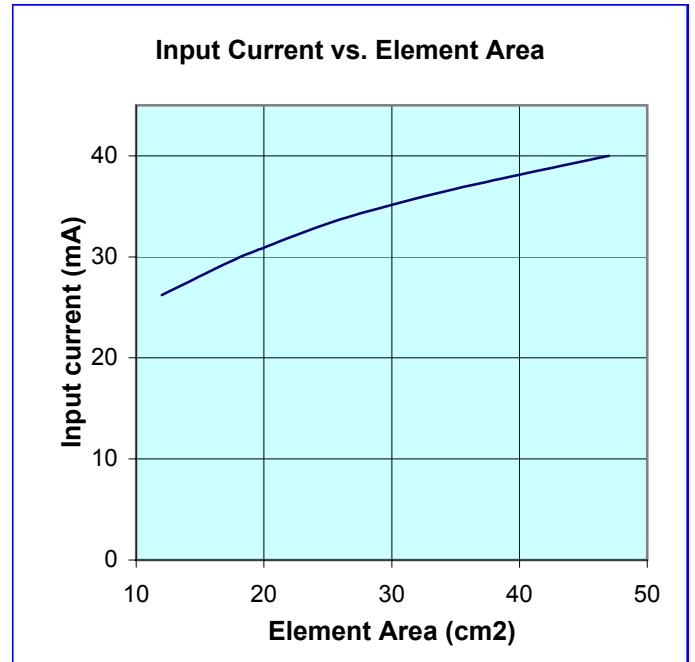
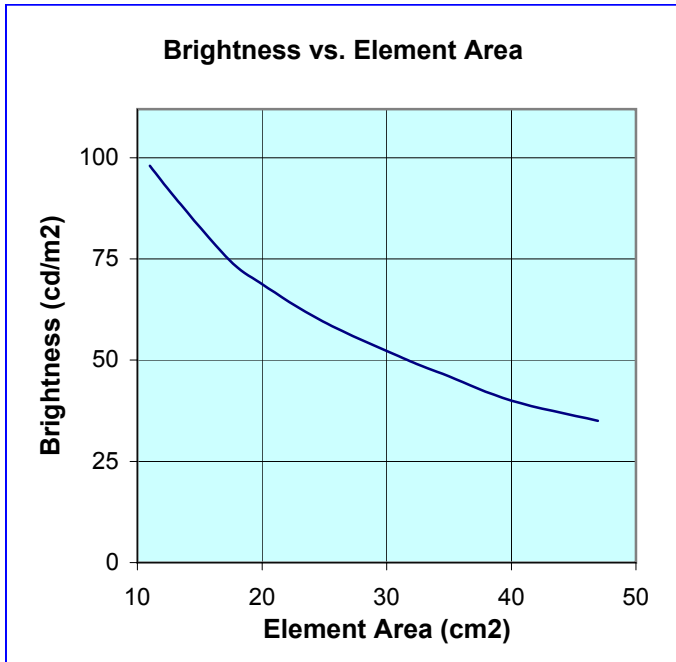

LOAD CHARACTERISTICS DATA

INVERTER: NDL-204

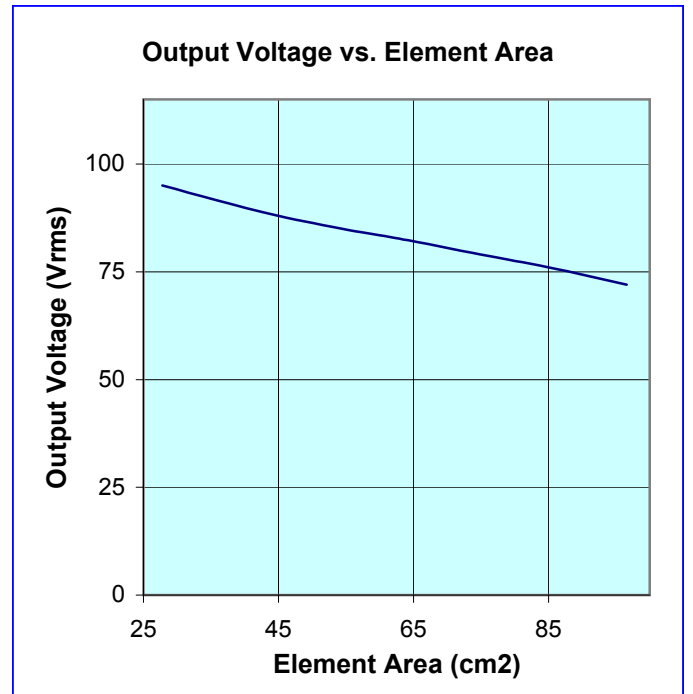
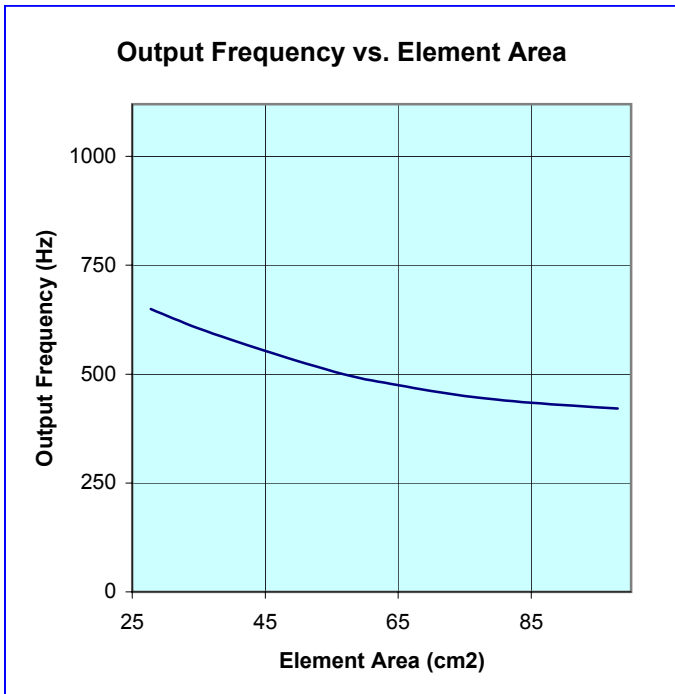
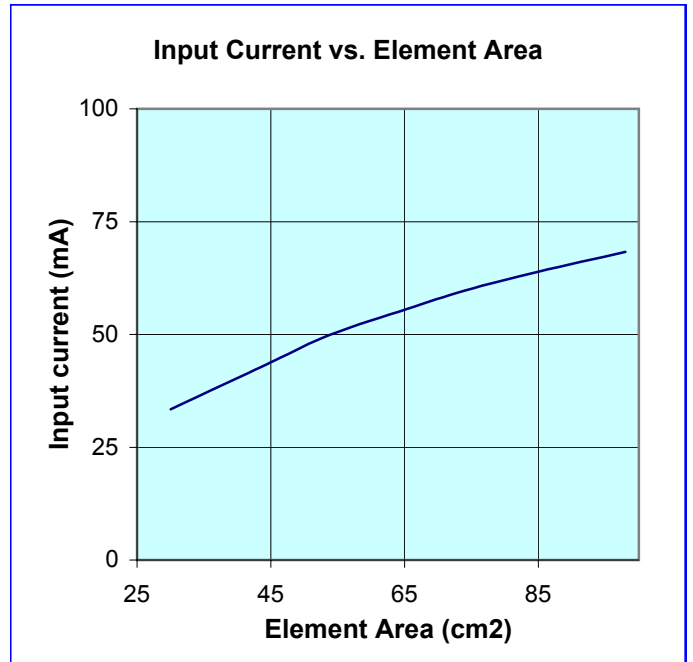
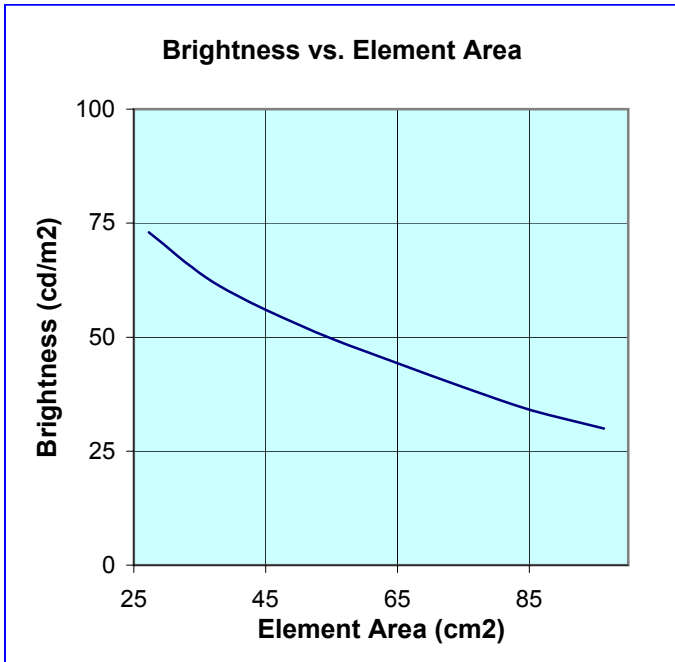

LOAD CHARACTERISTICS DATA

INVERTER: NDL-205

