



Chipsmall Limited consists of a professional team with an average of over 10 year of expertise in the distribution of electronic components. Based in Hongkong, we have already established firm and mutual-benefit business relationships with customers from,Europe,America and south Asia,supplying obsolete and hard-to-find components to meet their specific needs.

With the principle of “Quality Parts,Customers Priority,Honest Operation,and Considerate Service”,our business mainly focus on the distribution of electronic components. Line cards we deal with include Microchip,ALPS,ROHM,Xilinx,Pulse,ON,Everlight and Freescale. Main products comprise IC,Modules,Potentiometer,IC Socket,Relay,Connector.Our parts cover such applications as commercial,industrial, and automotives areas.

We are looking forward to setting up business relationship with you and hope to provide you with the best service and solution. Let us make a better world for our industry!



## Contact us

Tel: +86-755-8981 8866 Fax: +86-755-8427 6832

Email & Skype: info@chipsmall.com Web: www.chipsmall.com

Address: A1208, Overseas Decoration Building, #122 Zhenhua RD., Futian, Shenzhen, China



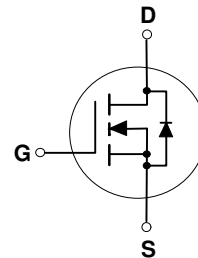
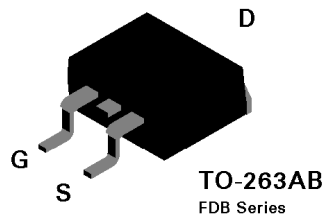
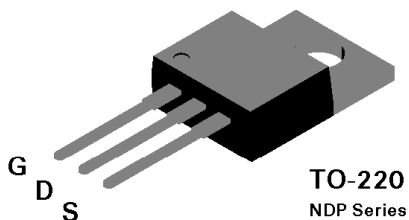
## NDP7050L / NDB7050L N-Channel Logic Level Enhancement Mode Field Effect Transistor

### General Description

These logic level N-Channel enhancement mode power field effect transistors are produced using Fairchild's proprietary, high cell density, DMOS technology. This very high density process has been especially tailored to minimize on-state resistance, provide superior switching performance, and withstand high energy pulses in the avalanche and commutation modes. These devices are particularly suited for low voltage applications such as automotive, DC/DC converters, PWM motor controls, and other battery powered circuits where fast switching, low in-line power loss, and resistance to transients are needed.

### Features

- 75A, 50V,  $R_{DS(ON)} = 0.015\Omega @ V_{GS} = 5V$
- Low drive requirements allowing operation directly from logic drivers.  $V_{GS(TH)} < 2.0V$ .
- Critical DC electrical parameters specified at elevated temperature.
- Rugged internal source-drain diode can eliminate the need for an external Zener diode transient suppressor.
- 175°C maximum junction temperature rating.
- High density cell design for extremely low  $R_{DS(ON)}$ .
- TO-220 and TO-263 (D<sup>2</sup>PAK) package for both through hole and surface mount applications.



### Absolute Maximum Ratings $T_c = 25^\circ\text{C}$ unless otherwise noted

Symbol	Parameter	NDP7050L	NDB7050L	Units
$V_{DSS}$	Drain-Source Voltage	50		V
$V_{DGR}$	Drain-Gate Voltage ( $R_{GS} \leq 1\text{ M}\Omega$ )	50		V
$V_{GSS}$	Gate-Source Voltage - Continuous	$\pm 20$		V
	- Nonrepetitive ( $t_p < 50\ \mu\text{s}$ )	$\pm 40$		
$I_D$	Drain Current - Continuous	75		A
	- Pulsed	225		
$P_D$	Total Power Dissipation @ $T_c = 25^\circ\text{C}$	150		W
	Derate above $25^\circ\text{C}$	1		
$T_J, T_{STG}$	Operating and Storage Temperature Range	-65 to 175		$^\circ\text{C}$

**Electrical Characteristics** ( $T_c = 25^\circ\text{C}$  unless otherwise noted)

Symbol	Parameter	Conditions	Min	Typ	Max	Units
<b>DRAIN-SOURCE AVALANCHE RATINGS</b> (Note 1)						
$W_{DSS}$	Single Pulse Drain-Source Avalanche Energy	$V_{DD} = 25\text{ V}, I_D = 75\text{ A}$			550	mJ
$I_{AR}$	Maximum Drain-Source Avalanche Current				75	A
<b>OFF CHARACTERISTICS</b>						
$BV_{DSS}$	Drain-Source Breakdown Voltage	$V_{GS} = 0\text{ V}, I_D = 250\text{ }\mu\text{A}$	50			V
$I_{DSS}$	Zero Gate Voltage Drain Current	$V_{DS} = 50\text{ V}, V_{GS} = 0\text{ V}$			250	$\mu\text{A}$
			$T_J = 125^\circ\text{C}$		1	mA
$I_{GSSF}$	Gate - Body Leakage, Forward	$V_{GS} = 20\text{ V}, V_{DS} = 0\text{ V}$			100	nA
$I_{GSSR}$	Gate - Body Leakage, Reverse	$V_{GS} = -20\text{ V}, V_{DS} = 0\text{ V}$			-100	nA
<b>ON CHARACTERISTICS</b> (Note 1)						
$V_{GS(th)}$	Gate Threshold Voltage	$V_{DS} = V_{GS}, I_D = 250\text{ }\mu\text{A}$	1	1.3	2	V
			$T_J = 125^\circ\text{C}$	0.65	0.8	
$R_{DS(on)}$	Static Drain-Source On-Resistance	$V_{GS} = 5\text{ V}, I_D = 37.5\text{ A}$		0.01	0.015	$\Omega$
			$T_J = 125^\circ\text{C}$		0.016	
$I_{D(on)}$	On-State Drain Current	$V_{GS} = 5\text{ V}, V_{DS} = 10\text{ V}$	75			A
$g_{FS}$	Forward Transconductance	$V_{DS} = 10\text{ V}, I_D = 37.5\text{ A}$	15	67		S
<b>DYNAMIC CHARACTERISTICS</b>						
$C_{iss}$	Input Capacitance	$V_{DS} = 25\text{ V}, V_{GS} = 0\text{ V},$ $f = 1.0\text{ MHz}$		4200	4000	pF
$C_{oss}$	Output Capacitance			1100	1600	pF
$C_{riss}$	Reverse Transfer Capacitance			310	800	pF
<b>SWITCHING CHARACTERISTICS</b> (Note 1)						
$t_{D(on)}$	Turn - On Delay Time	$V_{DD} = 30\text{ V}, I_D = 75\text{ A},$ $V_{GS} = 5\text{ V}, R_{GEN} = 10\Omega$ $R_{GS} = 10\Omega$		23	40	nS
$t_r$	Turn - On Rise Time			460	600	nS
$t_{D(off)}$	Turn - Off Delay Time			100	150	nS
$t_f$	Turn - Off Fall Time			270	400	nS
$Q_g$	Total Gate Charge	$V_{DS} = 48\text{ V},$ $I_D = 75\text{ A}, V_{GS} = 5\text{ V}$		86	115	nC
$Q_{gs}$	Gate-Source Charge			13		nC
$Q_{gd}$	Gate-Drain Charge			62		nC

**Electrical Characteristics** ( $T_c = 25^\circ\text{C}$  unless otherwise noted)

Symbol	Parameter	Conditions	Min	Typ	Max	Units
<b>DRAIN-SOURCE DIODE CHARACTERISTICS</b>						
$I_S$	Maximum Continuous Drain-Source Diode Forward Current				75	A
$I_{SM}$	Maximum Pulsed Drain-Source Diode Forward Current				225	A
$V_{SD}$	Drain-Source Diode Forward Voltage	$V_{GS} = 0\text{ V}$ , $I_S = 37.5\text{ A}$ (Note 1)		0.92	1.3	V
			$T_J = 125^\circ\text{C}$	0.85	1.2	
$t_{rr}$	Reverse Recovery Time	$V_{GS} = 0\text{ V}$ , $I_F = 60\text{ A}$ , $di_F/dt = 100\text{ A}/\mu\text{s}$		108	150	ns
$I_{rr}$	Reverse Recovery Current			4.6	10	A
<b>THERMAL CHARACTERISTICS</b>						
$R_{\theta JC}$	Thermal Resistance, Junction-to-Case				1	$^\circ\text{C}/\text{W}$
$R_{\theta JA}$	Thermal Resistance, Junction-to-Ambient				62.5	$^\circ\text{C}/\text{W}$

Note:

1. Pulse Test: Pulse Width  $\leq 300\ \mu\text{s}$ , Duty Cycle  $\leq 2.0\%$ .

## Typical Electrical Characteristics

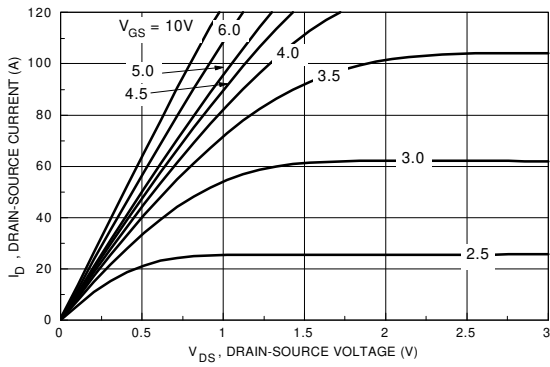


Figure 1. On-Region Characteristics

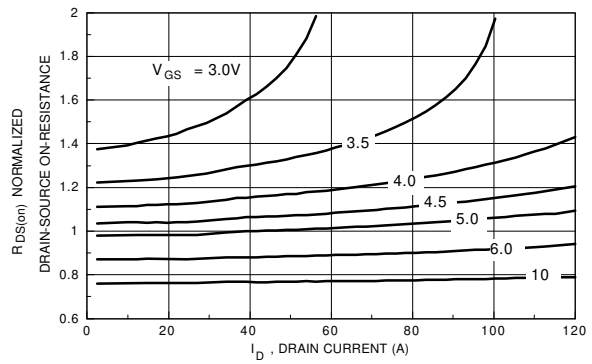


Figure 2. On-Resistance Variation with Gate Voltage and Drain Current

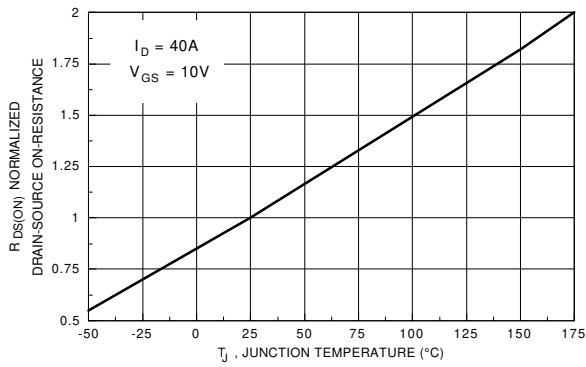


Figure 3. On-Resistance Variation with Temperature

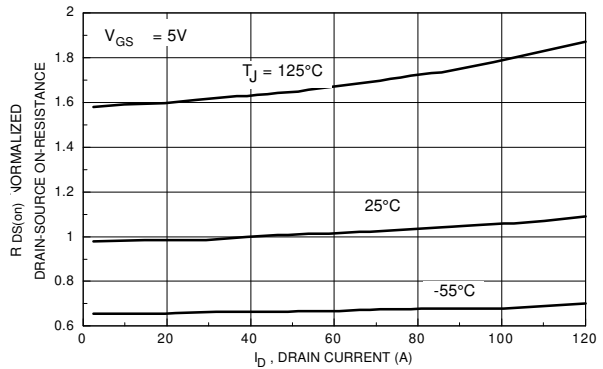


Figure 4. On-Resistance Variation with Drain Current and Temperature

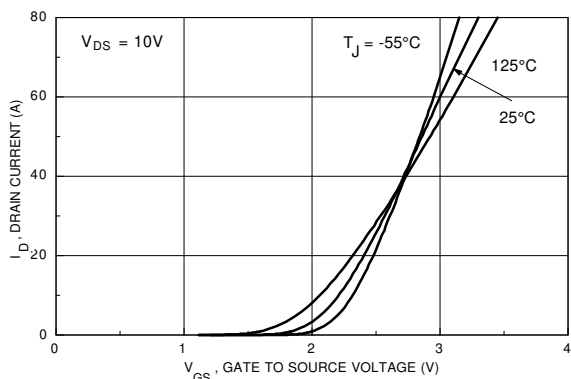


Figure 5. Transfer Characteristics

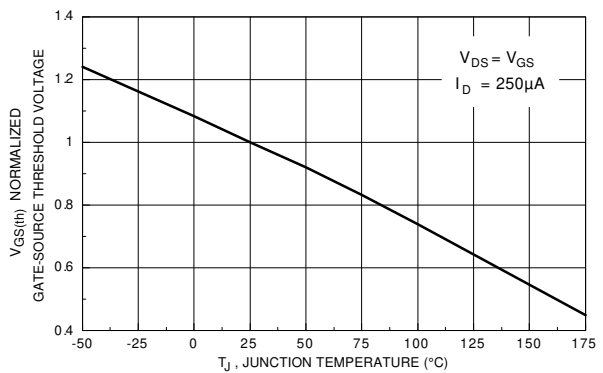
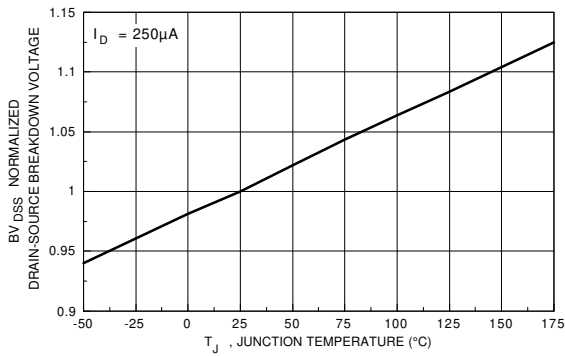
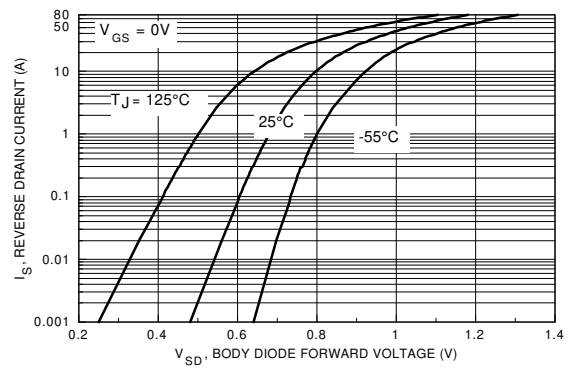


Figure 6. Gate Threshold Variation with Temperature

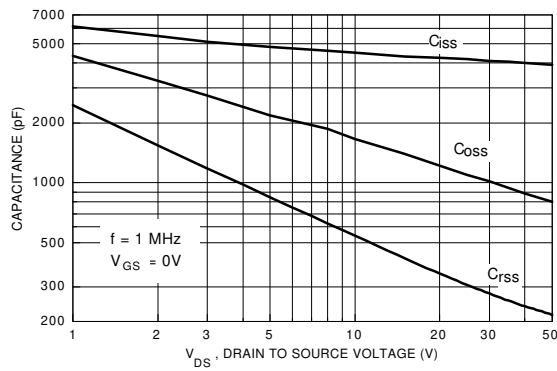
## Typical Electrical Characteristics (continued)



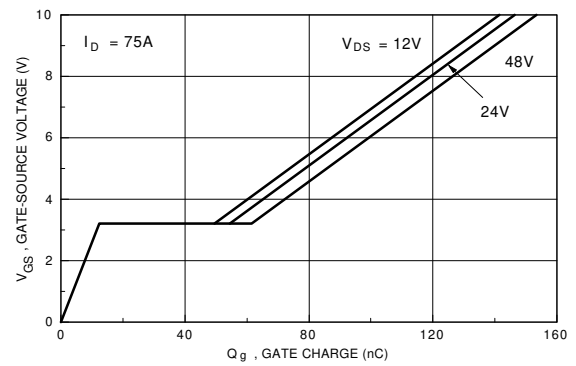
**Figure 7. Breakdown Voltage Variation with Temperature**



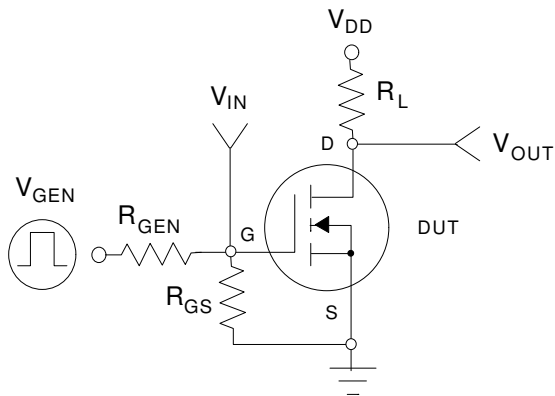
**Figure 8. Body Diode Forward Voltage Variation with Current and Temperature**



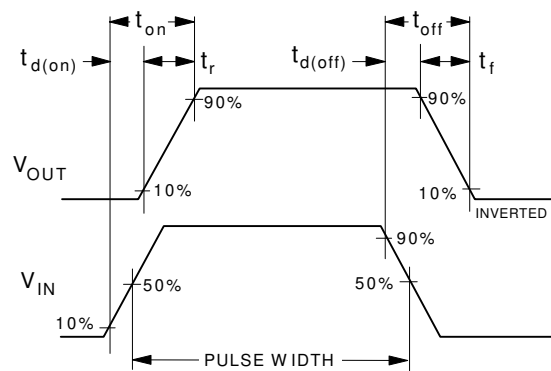
**Figure 9. Capacitance Characteristics**



**Figure 10. Gate Charge Characteristics**

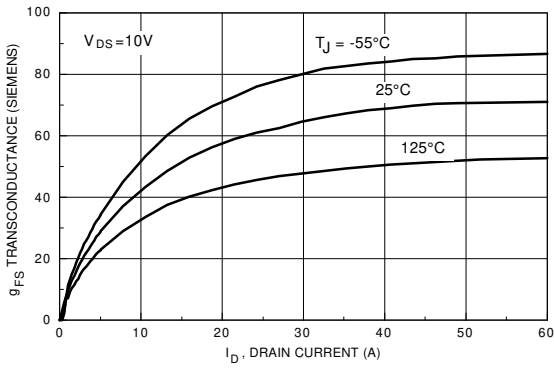


**Figure 11. Switching Test Circuit**

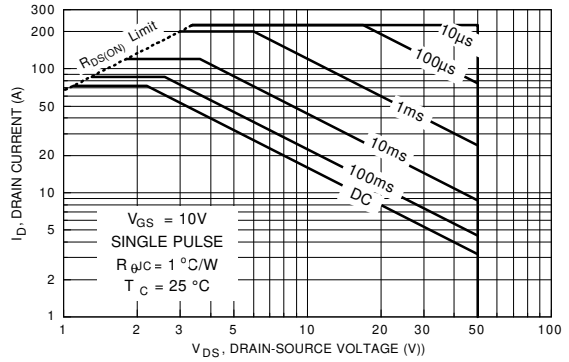


**Figure 12. Switching Waveforms**

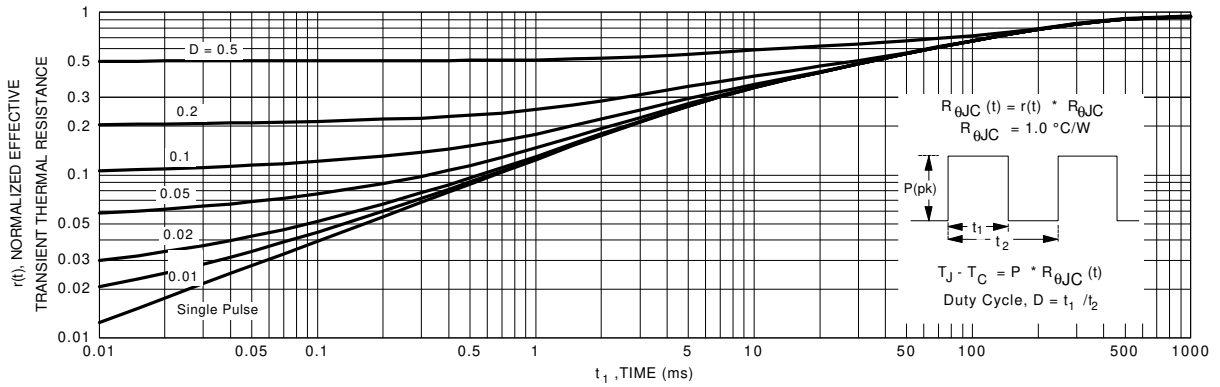
**Typical Electrical Characteristics (continued)**



**Figure 13. Transconductance Variation with Drain Current and Temperature**



**Figure 14. Maximum Safe Operating Area**



**Figure 15. Transient Thermal Response Curve**