



Chipsmall Limited consists of a professional team with an average of over 10 year of expertise in the distribution of electronic components. Based in Hongkong, we have already established firm and mutual-benefit business relationships with customers from,Europe,America and south Asia,supplying obsolete and hard-to-find components to meet their specific needs.

With the principle of “Quality Parts,Customers Priority,Honest Operation,and Considerate Service”,our business mainly focus on the distribution of electronic components. Line cards we deal with include Microchip,ALPS,ROHM,Xilinx,Pulse,ON,Everlight and Freescale. Main products comprise IC,Modules,Potentiometer,IC Socket,Relay,Connector.Our parts cover such applications as commercial,industrial, and automotives areas.

We are looking forward to setting up business relationship with you and hope to provide you with the best service and solution. Let us make a better world for our industry!



## Contact us

Tel: +86-755-8981 8866 Fax: +86-755-8427 6832

Email & Skype: info@chipsmall.com Web: www.chipsmall.com

Address: A1208, Overseas Decoration Building, #122 Zhenhua RD., Futian, Shenzhen, China



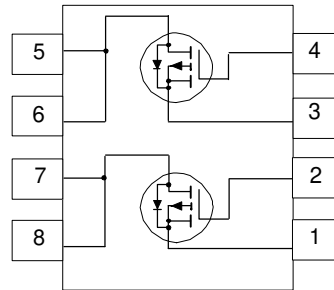
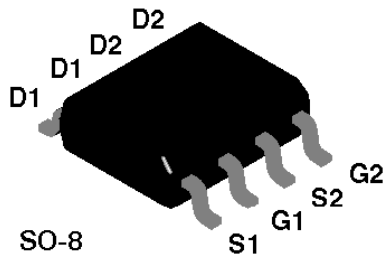
## NDS8934 Dual P-Channel Enhancement Mode Field Effect Transistor

### General Description

These P-Channel enhancement mode power field effect transistors are produced using Fairchild's proprietary, high cell density, DMOS technology. This very high density process is especially tailored to minimize on-state resistance, provide superior switching performance, and withstand high energy pulses in the avalanche and commutation modes. These devices are particularly suited for low voltage applications such as notebook computer power management and other battery powered circuits where fast switching, low in-line power loss, and resistance to transients are needed.

### Features

- -3.8A, -20V.  $R_{DS(ON)} = 0.07\Omega @ V_{GS} = -4.5V$   
 $R_{DS(ON)} = 0.1\Omega @ V_{GS} = -2.7V$ .
- High density cell design for extremely low  $R_{DS(ON)}$ .
- High power and current handling capability in a widely used surface mount package.
- Dual MOSFET in surface mount package.



### Absolute Maximum Ratings $T_A = 25^\circ\text{C}$ unless otherwise noted

Symbol	Parameter	NDS8934	Units
$V_{DSS}$	Drain-Source Voltage	-20	V
$V_{GSS}$	Gate-Source Voltage	-8	V
$I_D$	Drain Current - Continuous (Note 1a)	-3.8	A
	- Pulsed	-15	
$P_D$	Power Dissipation for Dual Operation	2	W
	Power Dissipation for Single Operation (Note 1a)	1.6	
	(Note 1b)	1	
	(Note 1c)	0.9	
$T_J, T_{STG}$	Operating and Storage Temperature Range	-55 to 150	$^\circ\text{C}$

### THERMAL CHARACTERISTICS

$R_{\theta JA}$	Thermal Resistance, Junction-to-Ambient (Note 1a)	78	$^\circ\text{C/W}$
$R_{\theta JC}$	Thermal Resistance, Junction-to-Case (Note 1)	40	$^\circ\text{C/W}$

**Electrical Characteristics** ( $T_A = 25^\circ\text{C}$  unless otherwise noted)

Symbol	Parameter	Conditions	Min	Typ	Max	Units	
<b>OFF CHARACTERISTICS</b>							
$BV_{DSS}$	Drain-Source Breakdown Voltage	$V_{GS} = 0\text{ V}, I_D = -250\ \mu\text{A}$	-20			V	
$I_{DSS}$	Zero Gate Voltage Drain Current	$V_{DS} = -16\text{ V}, V_{GS} = 0\text{ V}$			-1	$\mu\text{A}$	
		$V_{DS} = -10\text{ V}, V_{GS} = 0\text{ V}, T_J = 70^\circ\text{C}$			-5	$\mu\text{A}$	
$I_{GSSF}$	Gate - Body Leakage, Forward	$V_{GS} = 8\text{ V}, V_{DS} = 0\text{ V}$			100	nA	
$I_{GSSR}$	Gate - Body Leakage, Reverse	$V_{GS} = -8\text{ V}, V_{DS} = 0\text{ V}$			-100	nA	
<b>ON CHARACTERISTICS</b> (Note 2)							
$V_{GS(th)}$	Gate Threshold Voltage	$V_{DS} = V_{GS}, I_D = -250\ \mu\text{A}$		-0.5	-0.7	-1	V
			$T_J = 125^\circ\text{C}$	-0.3	-0.5	-0.8	
$R_{DS(on)}$	Static Drain-Source On-Resistance	$V_{GS} = -4.5\text{ V}, I_D = -3.8\text{ A}$		0.06	0.07	$\Omega$	
			$T_J = 125^\circ\text{C}$	0.085	0.14		
			$V_{GS} = -2.7\text{ V}, I_D = -3.2\text{ A}$	0.082	0.1		
$I_{D(on)}$	On-State Drain Current	$V_{GS} = -4.5\text{ V}, V_{DS} = -5\text{ V}$	-15			A	
			$V_{GS} = -2.7\text{ V}, V_{DS} = -5\text{ V}$	-5			
$g_{FS}$	Forward Transconductance	$V_{DS} = 10\text{ V}, I_D = -3.8\text{ A}$		9		S	
<b>DYNAMIC CHARACTERISTICS</b>							
$C_{iss}$	Input Capacitance	$V_{DS} = -10\text{ V}, V_{GS} = 0\text{ V},$ $f = 1.0\text{ MHz}$		1120		pF	
$C_{oss}$	Output Capacitance			470		pF	
$C_{rss}$	Reverse Transfer Capacitance			145		pF	
<b>SWITCHING CHARACTERISTICS</b> (Note 2)							
$t_{D(on)}$	Turn - On Delay Time	$V_{DD} = -5\text{ V}, I_D = -1\text{ A},$ $V_{GEN} = -4.5\text{ V}, R_{GEN} = 6\ \Omega$		13	20	ns	
$t_r$	Turn - On Rise Time			53	70	ns	
$t_{D(off)}$	Turn - Off Delay Time			60	80	ns	
$t_f$	Turn - Off Fall Time			33	40	ns	
$Q_g$	Total Gate Charge		$V_{DS} = -10\text{ V},$ $I_D = -3.8\text{ A}, V_{GS} = -4.5\text{ V}$		19	30	nC
$Q_{gs}$	Gate-Source Charge			2.4		nC	
$Q_{gd}$	Gate-Drain Charge			5.5		nC	

**Electrical Characteristics** ( $T_A = 25^\circ\text{C}$  unless otherwise noted)

Symbol	Parameter	Conditions	Min	Typ	Max	Units
<b>DRAIN-SOURCE DIODE CHARACTERISTICS AND MAXIMUM RATINGS</b>						
$I_S$	Maximum Continuous Drain-Source Diode Forward Current				-1.3	A
$V_{SD}$	Drain-Source Diode Forward Voltage	$V_{GS} = 0\text{ V}$ , $I_S = -1.3\text{ A}$ (Note 2)		-0.75	-1.2	V

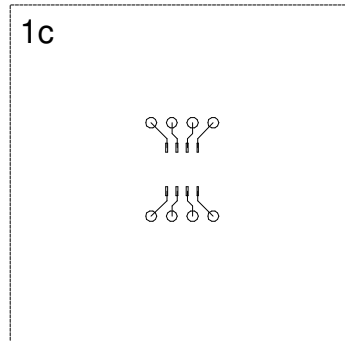
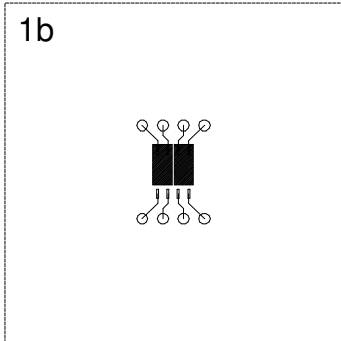
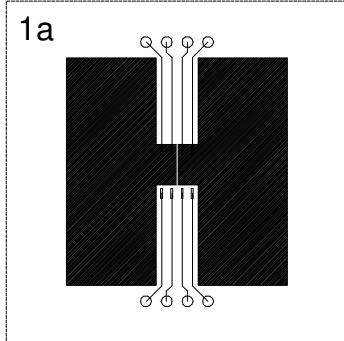
Notes:

- $R_{\theta JA}$  is the sum of the junction-to-case and case-to-ambient thermal resistance where the case thermal reference is defined as the solder mounting surface of the drain pins.  $R_{\theta JC}$  is guaranteed by design while  $R_{\theta CA}$  is determined by the user's board design.

$$P_D(t) = \frac{T_J - T_A}{R_{\theta JA}(t)} = \frac{T_J - T_A}{R_{\theta JC} + R_{\theta CA}(t)} = I_D^2(t) \times R_{DS(on)} \theta_{TJ}$$

Typical  $R_{\theta JA}$  for single device operation using the board layouts shown below on 4.5"x5" FR-4 PCB in a still air environment:

- 78°C/W when mounted on a 0.5 in<sup>2</sup> pad of 2oz copper.
- 125°C/W when mounted on a 0.02 in<sup>2</sup> pad of 2oz copper.
- 135°C/W when mounted on a 0.003 in<sup>2</sup> pad of 2oz copper.



Scale 1 : 1 on letter size paper

- Pulse Test: Pulse Width  $\leq 300\mu\text{s}$ , Duty Cycle  $\leq 2.0\%$ .

## Typical Electrical Characteristics

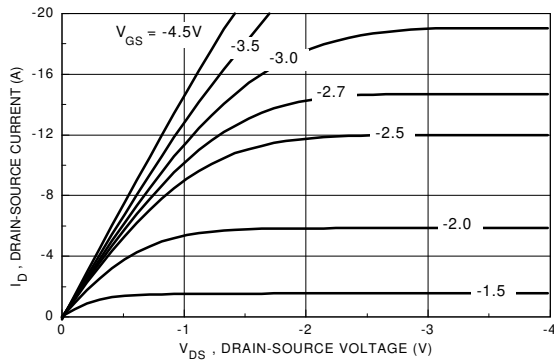


Figure 1. On-Region Characteristics.

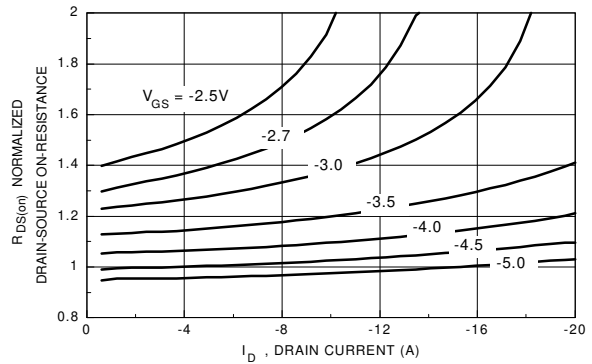


Figure 2. On-Resistance Variation with Gate Voltage and Drain Current.

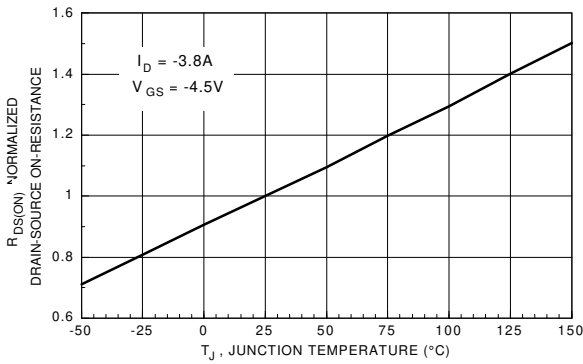


Figure 3. On-Resistance Variation with Temperature.

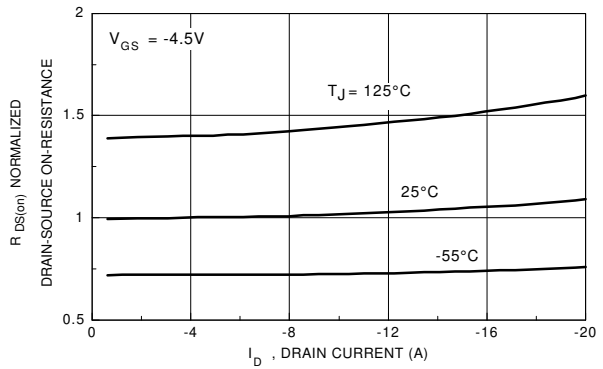


Figure 4. On-Resistance Variation with Drain Current and Temperature.

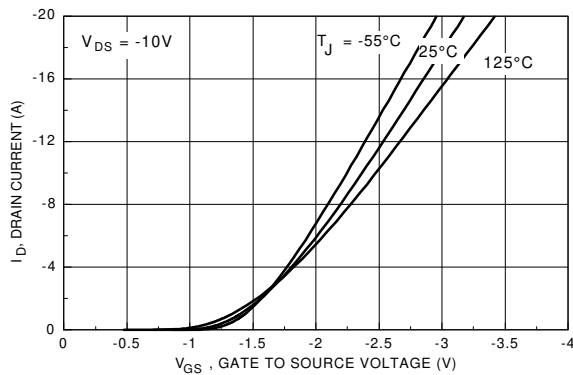


Figure 5. Transfer Characteristics.

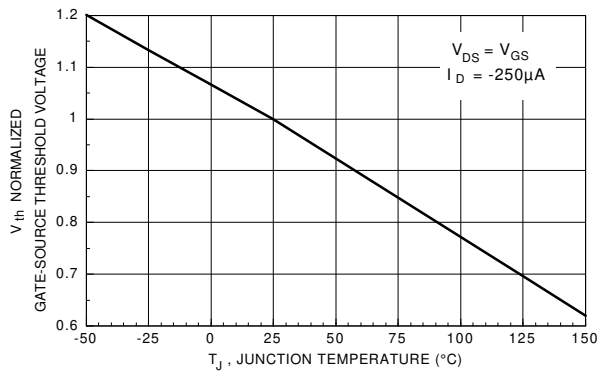
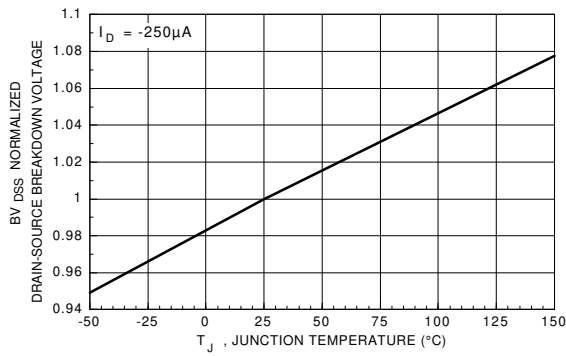
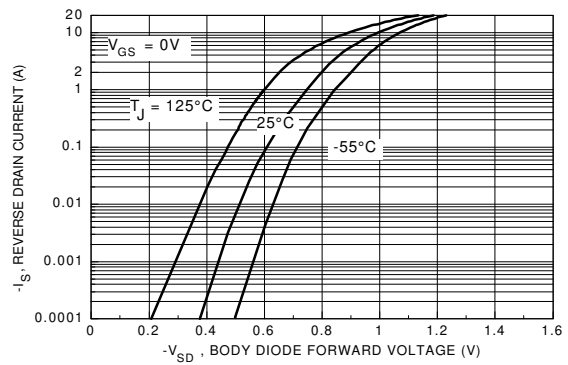


Figure 6. Gate Threshold Variation with Temperature.

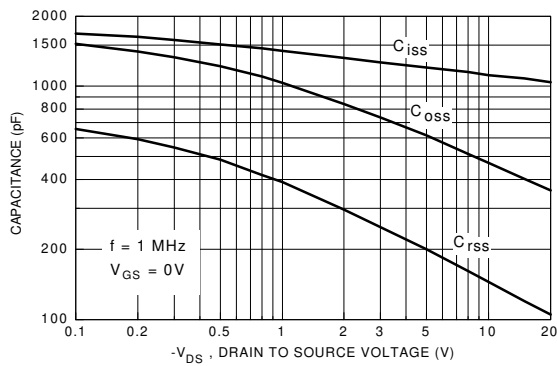
## Typical Electrical Characteristics



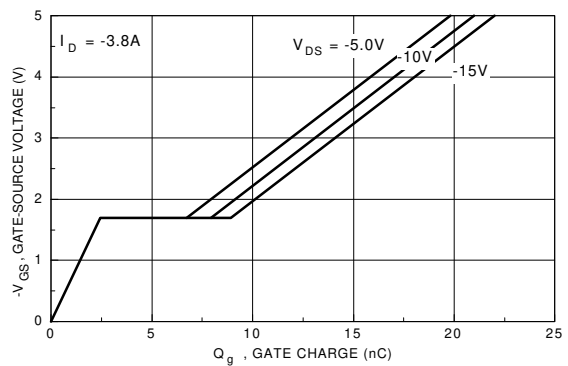
**Figure 7. Breakdown Voltage Variation with Temperature.**



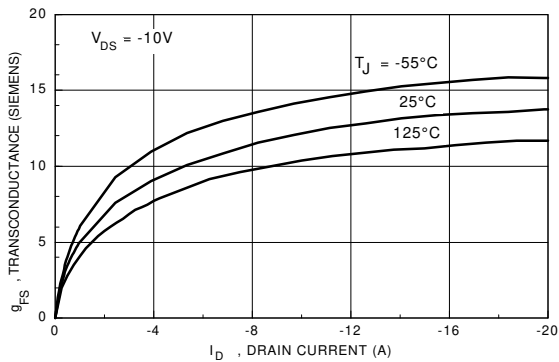
**Figure 8. Body Diode Forward Voltage Variation with Current and Temperature.**



**Figure 9. Capacitance Characteristics.**

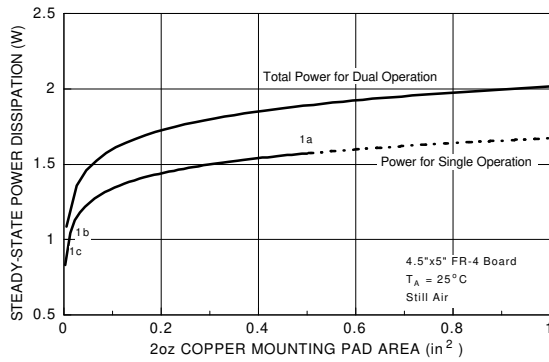


**Figure 10. Gate Charge Characteristics.**

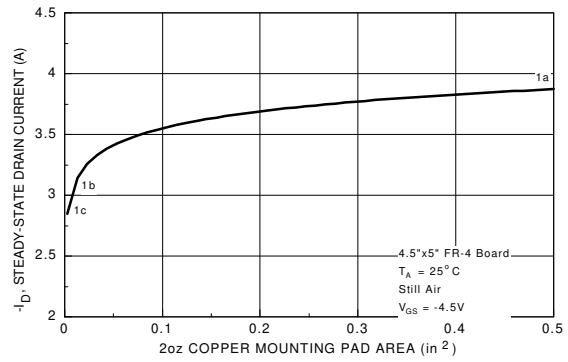


**Figure 11. Transconductance Variation with Drain Current and Temperature.**

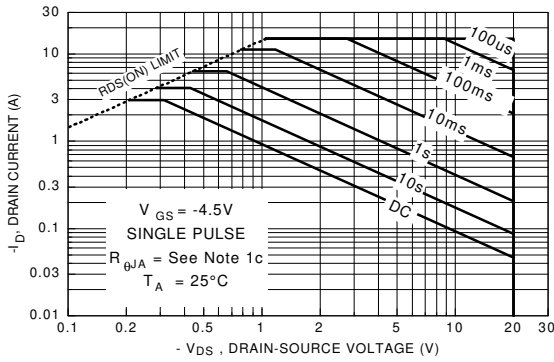
## Typical Thermal Characteristics



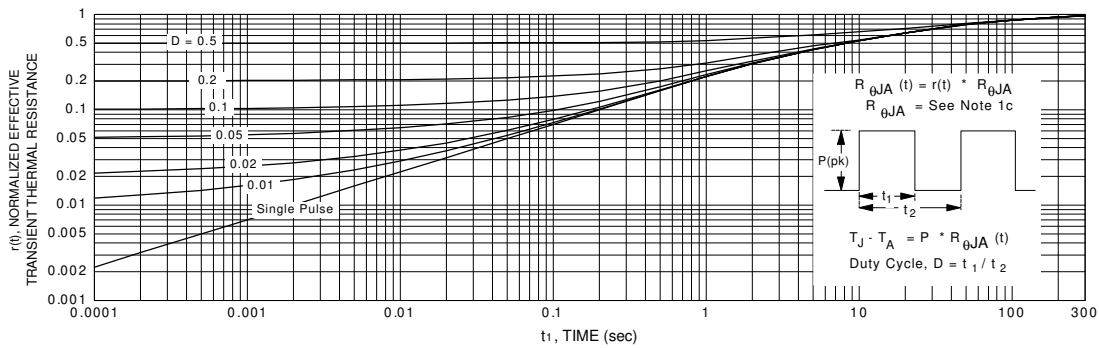
**Figure 12. SO-8 Dual Package Maximum Steady-State Power Dissipation versus Copper Mounting Pad Area.**



**Figure 13. Maximum Steady-State Drain Current versus Copper Mounting Pad Area.**



**Figure 14. Maximum Safe Operating Area.**



**Figure 15. Transient Thermal Response Curve.**

Note: Thermal characterization performed using the conditions described in note 1c. Transient thermal response will change depending on the circuit board design.

## TRADEMARKS

The following are registered and unregistered trademarks Fairchild Semiconductor owns or is authorized to use and is not intended to be an exhaustive list of all such trademarks.

ACE <sub>x</sub> <sup>™</sup>	FAST <sup>®</sup>	OPTOLOGIC <sup>™</sup>	SMART START <sup>™</sup>	VCX <sup>™</sup>
Bottomless <sup>™</sup>	FAST <sub>r</sub> <sup>™</sup>	OPTOPLANAR <sup>™</sup>	STAR*POWER <sup>™</sup>	
CoolFET <sup>™</sup>	FRFET <sup>™</sup>	PACMAN <sup>™</sup>	Stealth <sup>™</sup>	
CROSSVOLT <sup>™</sup>	GlobalOptoisolator <sup>™</sup>	POP <sup>™</sup>	SuperSOT <sup>™</sup> -3	
DenseTrench <sup>™</sup>	GTO <sup>™</sup>	Power247 <sup>™</sup>	SuperSOT <sup>™</sup> -6	
DOMET <sup>™</sup>	HiSeC <sup>™</sup>	PowerTrench <sup>®</sup>	SuperSOT <sup>™</sup> -8	
EcoSPARK <sup>™</sup>	ISOPLANAR <sup>™</sup>	QFET <sup>™</sup>	SyncFET <sup>™</sup>	
E <sup>2</sup> CMOS <sup>™</sup>	LittleFET <sup>™</sup>	QS <sup>™</sup>	TinyLogic <sup>™</sup>	
EnSigna <sup>™</sup>	MicroFET <sup>™</sup>	QT Optoelectronics <sup>™</sup>	TruTranslation <sup>™</sup>	
FACT <sup>™</sup>	MicroPak <sup>™</sup>	Quiet Series <sup>™</sup>	UHC <sup>™</sup>	
FACT Quiet Series <sup>™</sup>	MICROWIRE <sup>™</sup>	SILENT SWITCHER <sup>®</sup>	UltraFET <sup>®</sup>	

STAR\*POWER is used under license

## DISCLAIMER

FAIRCHILD SEMICONDUCTOR RESERVES THE RIGHT TO MAKE CHANGES WITHOUT FURTHER NOTICE TO ANY PRODUCTS HEREIN TO IMPROVE RELIABILITY, FUNCTION OR DESIGN. FAIRCHILD DOES NOT ASSUME ANY LIABILITY ARISING OUT OF THE APPLICATION OR USE OF ANY PRODUCT OR CIRCUIT DESCRIBED HEREIN; NEITHER DOES IT CONVEY ANY LICENSE UNDER ITS PATENT RIGHTS, NOR THE RIGHTS OF OTHERS.

## LIFE SUPPORT POLICY

FAIRCHILD'S PRODUCTS ARE NOT AUTHORIZED FOR USE AS CRITICAL COMPONENTS IN LIFE SUPPORT DEVICES OR SYSTEMS WITHOUT THE EXPRESS WRITTEN APPROVAL OF FAIRCHILD SEMICONDUCTOR CORPORATION.

As used herein:

1. Life support devices or systems are devices or systems which, (a) are intended for surgical implant into the body, or (b) support or sustain life, or (c) whose failure to perform when properly used in accordance with instructions for use provided in the labeling, can be reasonably expected to result in significant injury to the user.
2. A critical component is any component of a life support device or system whose failure to perform can be reasonably expected to cause the failure of the life support device or system, or to affect its safety or effectiveness.

## PRODUCT STATUS DEFINITIONS

### Definition of Terms

Datasheet Identification	Product Status	Definition
Advance Information	Formative or In Design	This datasheet contains the design specifications for product development. Specifications may change in any manner without notice.
Preliminary	First Production	This datasheet contains preliminary data, and supplementary data will be published at a later date. Fairchild Semiconductor reserves the right to make changes at any time without notice in order to improve design.
No Identification Needed	Full Production	This datasheet contains final specifications. Fairchild Semiconductor reserves the right to make changes at any time without notice in order to improve design.
Obsolete	Not In Production	This datasheet contains specifications on a product that has been discontinued by Fairchild semiconductor. The datasheet is printed for reference information only.