



Chipsmall Limited consists of a professional team with an average of over 10 year of expertise in the distribution of electronic components. Based in Hongkong, we have already established firm and mutual-benefit business relationships with customers from,Europe,America and south Asia,supplying obsolete and hard-to-find components to meet their specific needs.

With the principle of "Quality Parts,Customers Priority,Honest Operation,and Considerate Service",our business mainly focus on the distribution of electronic components. Line cards we deal with include Microchip,ALPS,ROHM,Xilinx,Pulse,ON,Everlight and Freescale. Main products comprise IC,Modules,Potentiometer,IC Socket,Relay,Connector.Our parts cover such applications as commercial,industrial, and automotives areas.

We are looking forward to setting up business relationship with you and hope to provide you with the best service and solution. Let us make a better world for our industry!



## Contact us

Tel: +86-755-8981 8866 Fax: +86-755-8427 6832

Email & Skype: info@chipsmall.com Web: www.chipsmall.com

Address: A1208, Overseas Decoration Building, #122 Zhenhua RD., Futian, Shenzhen, China



A Business Partner of Renesas Electronics Corporation.

**CEL** California Eastern Laboratories

2012

# RF & Wireless Semiconductors

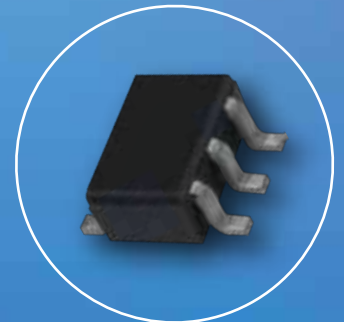
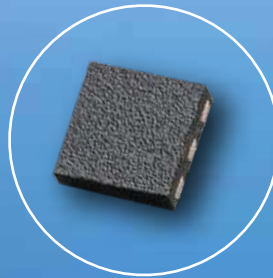
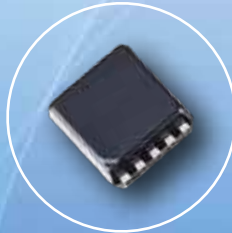
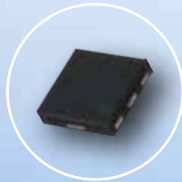



California Eastern Laboratories (CEL) is the exclusive sales and marketing partner in North America and Latin America for products made by the Compound Semiconductor Devices Business Division (CSDBD) of Renesas Electronics Corporation, formerly NEC Electronics Corporation. These products include RF components and RFICs, optocouplers, solid state relays, and lasers and detectors for fiber optics.

CEL serves designers, OEMs and contract manufacturers in the RF & Wireless, Mobilecomm, Multimedia, Broadband Communications, Industrial Control, and Automated Test Equipment (ATE) markets. With over 50 years experience in high frequency design, customer support and fulfillment, CEL is ideally positioned to provide its customers with solutions tailored to meet their specific needs.

CEL also maintains extensive inventories and provides engineering and applications assistance at its technical centers in Santa Clara, CA. and Wauconda, IL. The company supports customers through sales offices, sales representatives and distributors in numerous locations.

## PRODUCTS by APPLICATION

<b>Front End Components for 450 MHz to 2.5 GHz Applications</b>	<b>4</b>
<b>External LNAs for GPS</b>	<b>5</b>
<b>802.15.4/ZigBee Range Extension Devices</b>	<b>6</b>
<b>LNAs for L to C-Band Applications</b>	<b>7</b>
<b>2.4 &amp; 5.8 GHz WLAN/Wi-Fi Devices</b>	<b>8</b>
<b>WiMAX Devices</b>	<b>9</b>

## PRODUCT SPECIFICATIONS

<b>GaAs RFIC Switches</b>	
SPDT Dual Control Switches	10
SPDT Single Control Switches	10
Single & Multi-Throw Switches	10
Broadband Switches to 6 GHz	11
MobileComm Antenna Switches	11
<b>GaAs FETs and RFIC Amplifiers</b>	
Low Noise GaAs FETs, 100 MHz to 20 GHz	12
GaAs RFIC Power Amplifiers	12
<b>GaAs Integrated Front End ICs</b>	13
<b>GaAs CATV Hybrid Amplifiers</b>	13
<b>Silicon LD-MOSFET Power Devices</b>	14
<b>Silicon Bipolar Transistors</b>	
Small Signal Silicon Devices	14
Small Signal SiGe Devices	15
Medium Power Transistors	15
Transistors for Cordless Phones	15
Twin Transistors, Mixed & Matched Die	16
Silicon Transistor Chips	16
Oscillator and Switching Transistors	16
<b>Silicon RFICs</b>	
Low Power and Wideband Amplifiers	17
Low Noise Amplifiers	18
BiCMOS Wideband LNAs with Tx/Rx Bypass	18
AGC Amplifiers with Video Output	18
Variable Gain Amplifiers	18
Frequency Up and Down Converters	19
Out-of-Band Tuners	19
Prescalers (Frequency Dividers)	19
<b>Package Dimensions</b>	20

**S-Parameters, SPICE Models, App Notes, Data Sheets, and more are available at [cel.com/RF](http://cel.com/RF)**

# Front End Components for 450 MHz to 2.5 GHz Applications

Wi-Fi • Bluetooth • ZigBee • Automated Meter Reading • Mesh & Home Area Networks • ISM Band applications

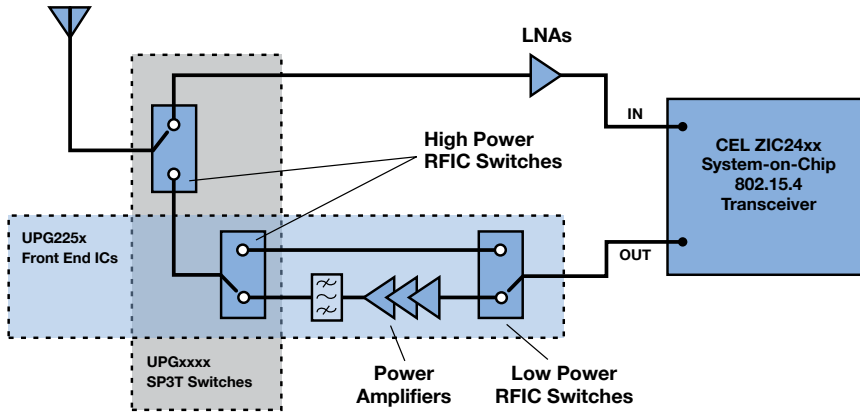

Front End		450 MHz	915 MHz	2.4 GHz
<b>UPG2253T6S</b>	+19 to +21dBm GaAs RFIC: PA, 2 SPDTs, filter, Tx/Rx bypass path			✓
<b>MMIC &amp; Transistor Power Amplifiers</b>				
<b>UPG2118K</b>	+31.5dBm Three Stage GaAs MMIC	✓	✓	✓
<b>UPG2250T5N</b>	+25dBm GaAs MMIC, operates at 1.8 or 3.0 V		✓	✓
<b>UPG2301T5L</b>	+23dBm Two stage GaAs HBT		✓	✓
<b>UPG2314T5N</b>	+20dBm Low current GaAs MMIC		✓	✓
<b>UPG2251T6M</b>	+25dBm GaAs MMIC, fully matched			✓
<b>NE5500234</b>	Silicon LD-MOSFET: 32.5dBm Pout typ	✓	✓	
<b>NE5511279A</b>	Silicon LD-MOSFET: 40 dBm Pout typ	✓	✓	
<b>NE5531079A</b>	Silicon LD-MOSFET: 40dBm Pout typ	✓	✓	
<b>NESG250134</b>	0.8 Watt SiGe HBT	✓	✓	
<b>NESG260234</b>	1 Watt SiGe HBT	✓	✓	
<b>NESG270034</b>	2 Watt SiGe HBT	✓	✓	
<b>NE5520379A</b>	3 watt LDMOS FET: 35.5dBm Pout typ	✓	✓	
<b>NE664M04</b>	0.4 Watt Silicon Bipolar Transistor Driver	✓	✓	✓
<b>NE5520279A</b>	LDMOS FET: 32 dBm Pout typ	✓	✓	✓
<b>NESG2101M05</b>	120 mW SiGe Bipolar Transistor Driver	✓	✓	✓
<b>Medium &amp; High Power GaAs RFIC Switches</b>				
<b>UPG2155TB</b>	SPDT, low harmonics, ideal for high power applications	✓	✓	
<b>UPG2156TB</b>	SPDT, low harmonics, single control	✓	✓	✓
<b>UPG2409TB/T6X</b>	SPDT, high power, high isolation	✓	✓	✓
<b>UPG2415TK/T6X</b>	SPDT, high power, high isolation	✓	✓	✓
<b>UPG2009TB</b>	SPDT, high power, high linearity, <i>no compromise</i> performance	✓	✓	✓
<b>UPG2015TB</b>	SPDT, medium power, single control	✓	✓	✓
<b>UPG2422TK</b>	SPDT, great all-around med power device, in mini flat-lead pkg	✓	✓	✓
<b>UPG2179TB</b>	SPDT, industry's best low cost, med power switch, industry standard pkg	✓	✓	✓
<b>UPG2406TK/T6R</b>	SPDT, medium power, choice of packages	✓	✓	✓
<b>UPG2404T6Q</b>	SP3T, high power, ideal for triple mode cellular phone, NFC	✓	✓	
<b>UPG2405T6Q</b>	SP3T, miniature package for Bluetooth, WLAN, NFC	✓	✓	✓
<b>UPG2413T6M/ T6Z</b>	SP3T, medium power, low insertion loss, low profile package	✓	✓	✓
<b>UPG2150T5L</b>	SP3T, 35dB isolation between WLAN & B'tooth ports		✓	✓
<b>Low Power CMOS &amp; GaAs RFIC Switches</b>				
<b>UPD5713TK</b>	Low cost CMOS SPDT, single control, low profile package	✓	✓	
<b>UPG2159T6R</b>	SPDT, low insertion loss, high isolation, 1.8 or 3 V		✓	✓
<b>UPG2012TB/TK</b>	Single control GaAs SPDT, TB or mini flat-lead TK package	✓	✓	✓
<b>UPG2214TB/TK</b>	Low cost GaAs SPDT, performance guaranteed at 1.8 & 3.0 Volts	✓	✓	✓

## Front End Components for 450 MHz to 2.5 GHz *continued*

MMIC & Transistor LNAs (Performance @ 1 GHz)		450 MHz	915 MHz	2.4 GHz
UPD5740T6N	Wideband CMOS LNA IC with bypass for mobile DTV	✓	✓	
UPC3237TK	SiGe:C RFIC: 1.4 dB NF, 15.3 dB Gain, for DTV	✓	✓	
NE662M04	Silicon Bipolar Transistor: 1.0 dB NF, 21 dB Gain	✓	✓	✓
NESG3031M05/M14	SiGe Bipolar Transistor: 0.6 dB NF, 16 dB Gain		✓	✓
UPC8233TK	SiGe:C RFIC: 0.95 dB NF, 20 dB Gain, 1.8V VCC		✓	✓
NESG3032M14	SiGe Bipolar Transistor: 0.6 dB NF, 17.5 dB Gain		✓	✓
NESG3033M14	SiGe Bipolar Transistor: 0.6 dB NF, 17.5 dB Gain, ESD protection		✓	✓
NE3508M04	GaAs FET: 0.4 dB NF, 14 dB Gain, high linearity			✓
NE3509M04	GaAs FET: 0.4 dB NF, 18 dB Gain, high gain			✓

## RFIC LNAs for Improved GPS Signal Performance

External LNAs reduce front-end noise and improve receiver sensitivity. Combined with tuning and distributed filtering they can improve noise performance by more than 1.5 dB over on-chip LNAs.

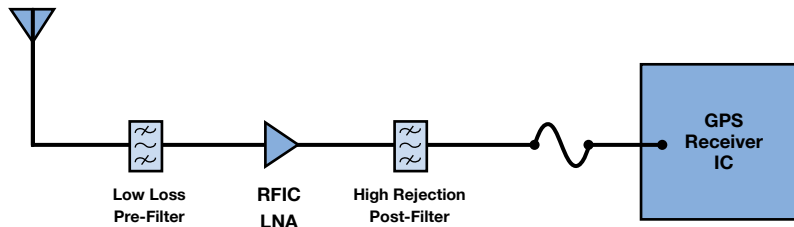

### SiGe & SiGe:C RFIC LNAs

Part Number	Description	Supply Voltage (V)	I <sub>CC</sub> (mA)	Noise Figure (dB)	Gain (dB)	IIP <sub>3</sub> (dBm)	Total External Components Req'd	Package
UPC8211TK	Low current	3.0	3.5	1.30	18.5	-12	9	TK
UPC8230TU	Low noise & distortion, highly integrated	3.0	6.0	0.85	18.5	-5	5	TU
UPC8231TK	Low noise & current, high gain	3.0	3.8	0.80	20	-10	9	TK
UPC8233TK	Low voltage, current & noise, high gain	2.7	3.5	0.90	20	-8.5	8	TK
UPC8236T6N	Low voltage, noise & distortion, highly integrated	2.7	6.5	0.80	19.5	-3	5	T6N low profile
UPC8240T6N	Low voltage & noise, high gain, highly integrated	2.7	6.5	1.0	28	-21.5	5	T6N low profile
UPC8244T6N <sup>1</sup>	Low voltage, noise & distortion, adjustable current, gain, high IIP <sub>3</sub>	2.7	3 - 10	0.80	14.5 - 18.5	0 - +5	7	T6N low profile

Notes: 1. Under development, please inquire

# Range Extension Components for 802.15.4/ZigBee Applications

Our Power Amplifiers, LNAs and RFIC Switches are designed to integrate easily with a wide variety of 802.15.4, ZigBee and Bluetooth transceivers ICs — including CEL's ZIC24xx MeshConnect transceiver and complete SoC solutions.

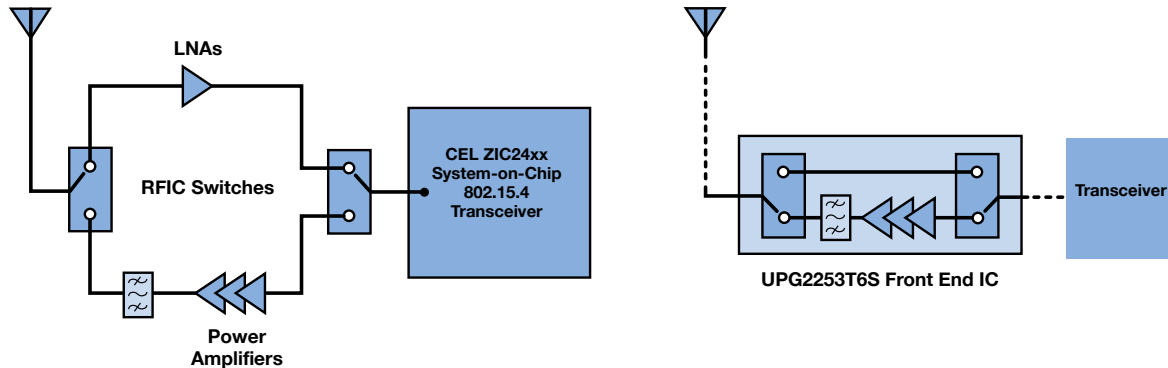

## Front End ICs

**UPG2253T6S** +19 to +21dBm GaAs RFIC: PA, 2 SPDTs, filter, Tx/Rx bypass path

## GaAs MMIC Power Amplifiers

**UPG2118K** +31.5dBm P<sub>OUT</sub>, 50% PAE

**UPG2250T5N** +20 dBm P<sub>OUT</sub> @ 1.8 V<sub>DD</sub>, 50% PAE

**UPG2251T6M** +25dBm P<sub>OUT</sub> @ 3.0V, 47% PAE, with matching circuit

**UPG2314T5N** +20dBm P<sub>OUT</sub>, 65mA operating current, 50% PAE, 20dB variable gain control

**UPG2301T5L** +23dBm P<sub>OUT</sub>, 50% PAE, 20dB variable gain control

## GaAs RFIC SPDT Switches

**UPG2012TK/TB** Low power, single control voltage

**UPG2015TB** Medium power, single control voltage, industry-standard package

**UPG2422TK** Low insertion loss, high isolation, 1.8-5.3V operation

**UPG2179TB** Industry's best medium power SPDT, and most cost-effective

**UPG2214TB/TK** 1.8/3.0V control voltage, low insertion loss, high isolation

**UPG2406T6R** Medium power, 1.8-3.3V control voltage, 0.45dB Insertion Loss, +22.0dBm P<sub>IN</sub>(0.1dB)

**UPG2406TK** Medium power, 1.8-5.3V control voltage, 0.45dB Insertion Loss

**UPG2408TK** Medium power, 0.48dB Insertion Loss, 29dBm P<sub>IN</sub>(0.1dB)

## Transistor & MMIC LNAs

**NE662M04** Silicon NPN transistor, 1.3dB noise figure, 15dB gain

**NE3508M04** GaAs HJ FET, super low 0.45dB noise figure, 14dB gain, high linearity

**NE3509M04** GaAs HJ FET, super low 0.45dB noise figure, 18dB gain, high gain

**UPC8233TK** SiGe:C MMIC, 1.8 to 3.3V control voltage, 1.1 dB noise figure, 16.5dB gain

**NESG3031M05/M14** SiGe HBT, 0.6dB noise figure, 16dB gain

**NESG7030M04<sup>1</sup>** SiGe:C HBT, 0.75dB Noise Figure, 14 dB Gain@ 5.8GHz, built-in ESD protection

## CEL System-on-Chip Transceiver IC

**ZIC2410** RF Transceiver with 8051 MCU: +8dBm output power, 106dB link budget, scalable data rates to 1 Mbps, voice CODEC, 48 pin QFN or 72 pin VFBGA package

Notes: 1. Under development, please inquire

# Low Noise Amplifiers for L to C-Band Applications

First, second and third stage devices for applications from 1 to 8GHz

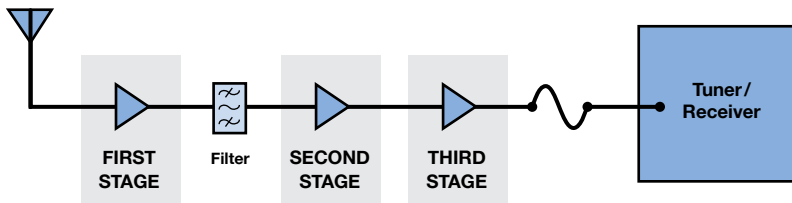

## LNAs by Application

Application	Frequency	FIRST STAGE	SECOND STAGE	THIRD STAGE
GPS	1.575 GHz	* UPC8211TK UPC8230TU UPC8231TK UPC8233TK UPC8236T6N UPC8240T6N UPC8244T6N <sup>1</sup>		
		NESG3032M14 NE3509M04/M14 NESG2031M05	NE662M04 NESG2031M05	
DAB and Satellite Radio	1.4 – 2.35GHz	NE3508M04 NE3509M04 NE3509M14 NE3510M04	NE3508M04 NESG2101M05 NESG2031M05 NESG3031M05 NESG7030M04 <sup>3</sup> NESG3032M14 NE662M04	NE3508M04 NESG2101M05
WLAN, Wi-Fi, Cordless Phone	2.4GHz	NESG2031M05 NESG3031M05 NESG3032M14 NESG3033M14	NESG2031M05 NESG3031M05 NESG7030M04 <sup>3</sup> NESG3032M14 NESG3033M14	
WLAN, Wi-Fi, Cordless Phone	5 – 6GHz	NESG2031M05 NESG2101M05 NESG3031M05 NESG4030M14 NESG7030M04 <sup>3</sup>	NESG2031M05 NESG2101M05 NESG3031M05 NESG4030M14 NESG7030M04 <sup>3</sup>	

## LNA Performance (see Data Tables for additional specifications)

Part Number	Description	NF (dB)	Gain (dB)	P1dB (dBm)	Package
-------------	-------------	---------	-----------	------------	---------

\* Low Noise, High Gain Silicon RFIC LNAs (specified @ 1.575GHz)

UPC8211TK	SiGe RFIC	1.3	18.5	-24	TK
UPC8230TU	SiGe:C RFIC	0.85	18.5	-17	TK
UPC8231TK	SiGe:C RFIC	0.8	20.0	-22	TK
UPC8233TK	SiGe:C RFIC	0.95	20.0	-23	TK
UPC8236T6N	SiGe:C RFIC	0.8	19.5	-18	T6N
UPC8240T6N	SiGe:C RFIC	1.0	28.0	-22.5	T6N
UPC8244T6N <sup>1</sup>	SiGe:C RFIC	1.0	19.0		T6N
NE3508M04	GaAs HJ-FET	0.40 @ 2.0GHz	14.0 @ 2.0GHz	+18.0	M04
NE3509M04/M14 <sup>2</sup>	GaAs HJ-FET	0.40 @ 2.0GHz	17.5 @ 2.0GHz	+14.0	M04 or M14
NE3510M04	GaAs HJ-FET	0.35 @ 2.0GHz	19.0 @ 2.0GHz	+12.0	M04 or M14
NE662M04	Silicon Transistor	1.1 @ 2.0GHz	16.0 @ 2.0GHz		M04
NESG2021M05/M16	SiGe Transistor	0.9 @ 2.0GHz	18 @ 2.0GHz	+9	M05 or M16
NESG2031M05	SiGe Transistor	0.8 @ 2.0GHz	17 @ 2.0GHz	+13	M05
NESG2101M05	SiGe Transistor	0.9 @ 2.0GHz	13 @ 2.0GHz	+21	M05
NESG3031M05/M14	SiGe Transistor	0.6 @ 2.4GHz	16 @ 2.4GHz	+13	M05 or M14
NESG3032M14	SiGe Transistor	0.6 @ 2.0GHz	17.5 @ 2.0GHz	+12.5	M14
NESG3033M14	SiGe Transistor	0.6 @ 2.0GHz	17.5 @ 2.0GHz	+12.5	M14
NESG4030M14	SiGe Transistor	1.1 @ 5.8GHz	11.5 @ 5.8GHz	+9	M14
NESG7030M04 <sup>3</sup>	SiGe:C Transistor	0.75 @ 5.8GHz	14 @ 5.8GHz	+4.5	M04

Notes: 1. Adjustable current device, under development, please inquire 2. NE3509M14 under development, please inquire 3. Under development, please inquire



## 2.4 & 5.8 GHz WLAN/Wi-Fi

Single and multi-throw switches and discrete Silicon and GaAs low noise amplifiers designed specifically for Dual Band WLAN

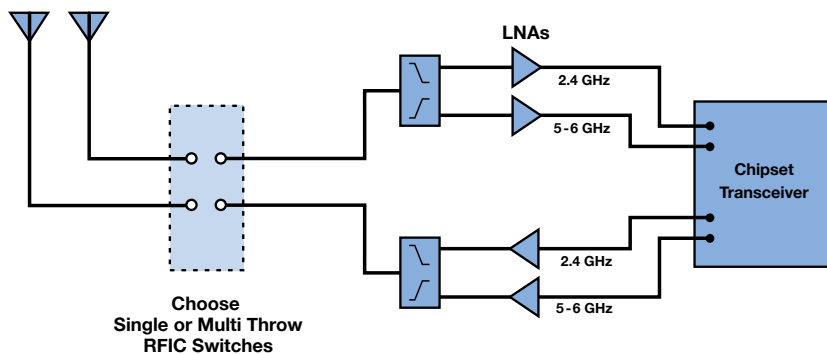

### GaAs RFIC Switches to 2.5GHz – Single & Multi Throw

UPG2179TB	SPDT, 0.3dB Insertion Loss @ 2GHz, industry-standard package
UPG2406T6R	SPDT, 0.45dB Insertion Loss @ 2GHz, +22.0dBm PIN(0.1dB) @ +1.8VCONT
UPG2406TK	SPDT, 1.8 or 2.7V control voltage, 0.45dB Insertion Loss @ 2GHz
UPG2418TB/T6X	SPDT, 50Ω termination, 0.45dB Insertion Loss, 21 dB Isolation @ 2.5GHz
UPG2150T5L	SP3T, 0.5dB Insertion Loss, 35dB Isolation between ports @ 2.5GHz
UPG2405T6Q	SP3T, 0.60dB Insertion Loss, 20dB Isolation @ 2.5GHz
UPG2413T6M	SP3T, 0.5dB Insertion Loss, 18dB Isolation @ 2.5GHz, 12 pin package
UPG2413T6Z	SP3T, 0.5dB Insertion Loss, 18dB Isolation @ 2.5GHz, 8 pin package

### GaAs RFIC Switches – Broadband to 6GHz

UPG2163T5N	SPDT, Insertion Loss: 0.4dB @ 2.4GHz, 0.5dB @ 6GHz
UPG2185T6R	SPDT, Insertion Loss: 0.4dB @ 2.5GHz, 0.5dB @ 6GHz, 25dB Isolation @ 6GHz
UPG2422TK	SPDT for Dual Band WLAN, very cost-effective
UPG2411T7C	SPDT for Dual Band WLAN, Insertion Loss: 0.6 dB @ 2.5GHz, 0.8 dB @ 6GHz
UPG2411T6R	SPDT for Dual Band WLAN, Insertion Loss: 0.4dB @ 2.5GHz, 0.5dB @ 6GHz, 1.8V specifications
UPG2428T7F <sup>1</sup>	SPDT for Dual Band WLAN, 1mm package with 0.5mm pitch
UPG2415TK / T6X	SPDT for Dual Band WLAN, high power, low insertion loss for Access Point applications
UPG2162T5N	DPDT, Insertion Loss: 0.6dB @ 2.4GHz, 0.85dB @ 5.5GHz
UPG2164T5N	DPDT, Insertion Loss: 0.5dB @ 2.4GHz, 0.7dB @ 5.5GHz
UPG2430T6Z <sup>1</sup>	SP3T, Insertion Loss: 0.65 dB @ 6 GHz; 1.8V specifications

### LNAs

NESG3031M05 / M14	SiGe HBT, 1.1 dB Noise Figure, 9.5dB Gain @ 2.4GHz
NESG3032M14	SiGe HBT, 0.6dB Noise Figure, 17.5dB Gain @ 2.0GHz
NESG3033M14	SiGe HBT, 0.6dB Noise Figure, 17.5dB Gain @ 2.0GHz, built-in ESD protection
NESG4030M14	SiGe HBT, 1.1 dB Noise Figure, 11.5dB Gain @ 5.8GHz, built-in ESD protection
NESG7030M04 <sup>1</sup>	SiGe:C HBT, 0.75dB Noise Figure, 14 dB Gain @ 5.8GHz, built-in ESD protection

Notes: 1. Under development, please inquire

Single and multi-throw switches and transistor and RFIC low noise amplifiers designed specifically for WiMAX

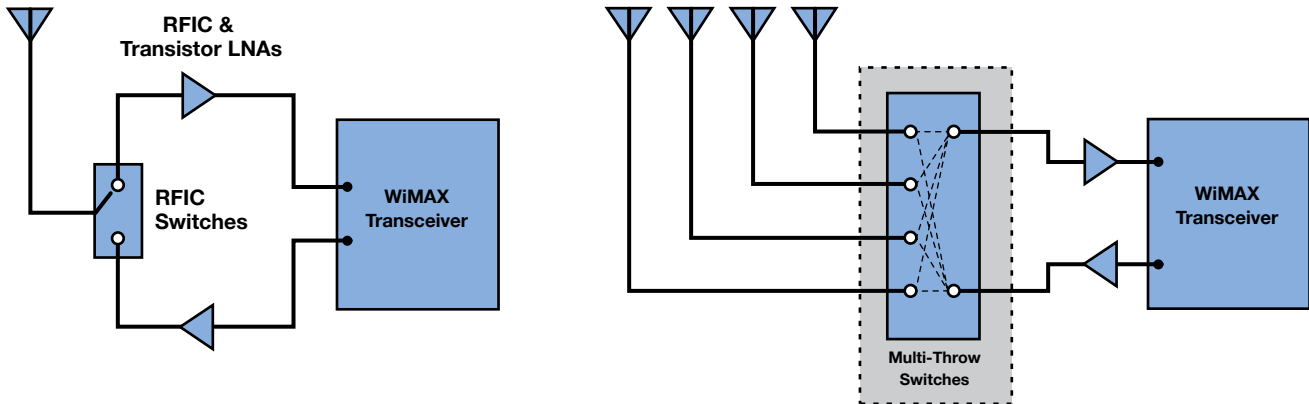

## GaAs RFIC Switches

<b>UPG2176T5N</b>	SPDT 2.4 – 6GHz, Insertion Loss: 0.5dB @ 2.4GHz, 0.7dB @ 5.5GHz, internal termination
<b>UPG2409TB</b>	SPDT 2.0 – 4.0GHz, Insertion Loss: 0.45dB @ 2.5GHz, 0.6dB @ 3.8GHz
<b>UPG2409T6X</b>	SPDT 2.0 – 6.0GHz, Insertion Loss: 0.45dB @ 2.5GHz, 0.65dB @ 6.0GHz
<b>UPG2181T5R</b>	+40dBm DP4T for antenna diversity and Tx/Rx switching, 1 dB Insertion Loss, 24dB Isolation @ 3.5 GHz

## Transistor & RFIC LNAs

<b>NESG3031M05 / M14</b>	High fr SiGe HBT, 0.6dB Noise Figure, 16dB Gain @ 2.5GHz
<b>NESG7030M04<sup>1</sup></b>	SiGe:C HBT, 0.75dB Noise Figure, 14 dB Gain@ 5.8GHz, built-in ESD protection
<b>NE3508M04</b>	GaAs HJ FET, super low 0.45dB noise figure, 14dB gain @ 2.5GHz, high linearity

Notes: 1. Under development, please inquire

# GaAs RFIC Switches: Single & Multi-Throw

## SPDT Dual Control Switches (Generally Specified to 3GHz)

Part Number	TYPICAL ELECTRICAL CHARACTERISTICS (T <sub>A</sub> = 25°C) Frequency range: 0.1 to 2.5 GHz						Package Code
	Features	Control Voltages (V)	Insertion Loss @2GHz (dB)	Isolation @2GHz (dB)	Input Power @0.1 dB compression point	Input Power @1.0 dB compression point	
UPG2009TB	High Power/High Linearity	+2.8/0	0.30	28	+34 dBm	NA	TB
UPG2030TK	Medium Power, Versatile	+2.8/0	0.30	27	+27 dBm	+30 dBm	TK
UPG2155TB	High Power, Low Harmonics	+2.6/0	0.40	19	+37 dBm	NA	TB
UPG2158T5K	Smallest Package, WiFi Reference Designs	+2.7/0	0.45	19	+29dBm	30.5dBm	T5K
UPG2159T6R	Low Insertion Loss, Small Pkg	+1.8, 2.7/0	0.23	27	+22 dBm	+25.5 dBm	T6R
UPG2179TB	Industry's best medium power	+3.0/0	0.30	27	+29 dBm	+32 dBm	TB
UPG2214TB	Hi Performance @ 3.0 or 1.8V	+1.8, 3.0/0	0.30	27	+23 dBm	+20 (1.8V), 26(3.0V)	TB
UPG2214TK	Hi Performance @ 3.0 or 1.8V	+1.8, 3.0/0	0.30	27	+23 dBm	+20 (1.8V), 26(3.0V)	TK
UPG2406TK	Medium Power, L, S Band	+1.8, 2.7/0	0.45	19	+29 dBm	+25 (1.8V), 30.5 (3.0V)	TK
UPG2406T6R	Medium Power, Small Pkg	2.7/0	0.45	19	+29 dBm	+30.5	T6R
UPG2408TK	Medium Power, compact	+3.0/0	0.48	19	+29 dBm	-	TK
UPG2418TB	Internally terminated	+3.0/0	0.45	21	+29 dBm	+32 dBm	TB
UPG2418T6X	Internally terminated	+3.0/0	0.37	23	+29dBm	+32	T6X

## Single & Multi-Throw Switches

Part Number	TYPICAL ELECTRICAL CHARACTERISTICS (T <sub>A</sub> = 25°C)						Package Code
	Features	Control Voltages (V)	Insertion Loss (dB)	Isolation (dB)	Input Power @ 0.1 dB compression point	Input Power @1.0 dB compression point	
UPG2150T5L	SP3T/WLAN, B'Tooth	+2.85/0	0.50@2.5GHz	35@2.5GHz	NA	+25 dBm <sup>1</sup> +31 dBm <sup>2</sup>	T5L
UPG2181T5R	DP4T / WiMAX	+3.0/0	1.0@3.8GHz	24@3.8GHz	NA	40Tx / 35Rx dBm	T5R
UPG2183T6C	SP4T / High Power	+3.0/0	0.4@0.9GHz 0.55 @ 2GHz	24 @ 0.9GHz 19 @ 2GHz	+37.5 dBm @ 0.9GHz +35 dBm @ 2GHz	NA	T6C
UPG2189TB	SPST / High Power	+2.6 / 0	0.35 @ 2GHz	13.5 @ 2GHz	+37 dBm	NA	TB
UPG2404T6Q	SP3T / High Power	+2.8/0	0.55 @ 2GHz	21 @ 2GHz	+33 dBm	NA	T6Q
UPG2405T6Q	SP3T / WiFi, B'Tooth	+2.8/0	0.60 @ 2.5GHz	20 @ 2.5GHz	+31 dBm	NA	T6Q
UPG2413T6M	SP3T / Med Power	+3.0/0	0.4 @ 1 GHz 0.5 @ 2.5GHz	26 @ 1 GHz 18 @ 2.5GHz	+28 dBm	+33 dBm	T6M
UPG2413T6Z	SP3T / Med Power	+3.0/0	0.4 @ 1 GHz 0.5 @ 2.5GHz	26 @ 1 GHz 18 @ 2.5GHz	+28 dBm	+31 dBm	T6M
UPG2417T6M	SP6T / NFC	+2.85/0	0.5@13.56GHz	50@13.56GHz	+32dBm	NA	T6M
UPD5731T6M	SP4T CMOS Low Power	+2.8/0	1.3@2GHz	26@2GHz	+17 dBm	+20 dBm	T6M
UPD5738T6N	DPDT Wide Band CMOS	+2.8/0	0.8 @ 1GHz	22 @ 1GHz	+15 dBm	+20 dBm	T6N
UPG2430T6Z <sup>3</sup>	SP3T/66Hz, low insertion loss	+3.0/0 +1.8/0	0.65@6GHz	25@6GHz	+28dBm +23dBm	+31dBm +25dBm	T6Z

Notes: 1. Port 3 2. Ports 1 and 2 3. Under development, please inquire

## SPDT Single Control Switches

Part Number	TYPICAL ELECTRICAL CHARACTERISTICS (T <sub>A</sub> = 25°C) Frequency range: 0.1 to 2.5 GHz						Package Code
	Features	Control Voltages (V)	Insertion Loss @2GHz (dB)	Isolation @2GHz (dB)	Input Power @0.1 dB compression point	Input Power @1.0 dB compression point	
UPD5713TK	Low Cost CMOS	+2.8/0	0.80	25	+17 dBm	+21 dBm	TK
UPG2010TB	High Power	+2.8/0	0.30	28	+33 dBm	NA	TB
UPG2012TB	Low Power	+2.8/0	0.30	28	+20.5 dBm	+24 dBm	TB
UPG2012TK	Miniature, Low Power	+2.8/0	0.30	28	+20.5 dBm	+24 dBm	TK
UPG2015TB	Medium Power	+2.8/0	0.30	28	+27 dBm	+30 dBm	TB
UPG2156TB	High Power	+2.6/0	0.45	17.5	+37 dBm	NA	TB

# GaAs RFIC Switches: Broadband & MobileComm

## Broadband SPDT and DPDT Switches to 6GHz

Part Number	TYPICAL ELECTRICAL CHARACTERISTICS (T <sub>A</sub> = 25°C)						Package Code
	Description	Control Voltages (V)	Insertion Loss (dB)	Isolation (dB)	Input Power @0.1 dB compression point	Input Power @1.0 dB compression point	
UPG2162T5N	DPDT 2.4 – 2.5 GHz 4.9 – 6.0GHz	+3.0/0	0.6 @ 2.4GHz 0.85 @ 5.5GHz	30 @ 2.4 GHz 27 @ 5.5 GHz	-	31 dBm 29 dBm	T5N
UPG2163T5N	SPDT 2.0 – 6.0GHz High Performance	+3.0/0	0.4 @ 2.5GHz 0.5 @ 6GHz	35 @ 2.5GHz 30 @ 6GHz	-	+35@2.5GHz +29@6GHz	T5N
UPG2164T5N	DPDT 2.4 – 2.5 GHz 4.9 – 6.0GHz	+3.0/0	0.5 @ 2.4GHz 0.7 @ 5.5GHz	25 @ 2.4GHz 17 @ 5.5GHz	-	31 dBm 29 dBm	T5N
UPG2176T5N	For WiMAX	+3.0/0	0.55 @ 3.5GHz	24 @ 3.5 GHz	-	+37dBm	T5N
UPG2185T6R	SPDT 2.0 – 6.0GHz High Performance	+3.0/0	0.55 @ 3.5GHz 0.5 @ 6GHz	26 @ 2.5GHz 25 @ 6GHz	+29 dBm	+30.5 dBm	T6R
UPG2409TB	SPDT High Power for WiMAX, WLAN	+3.0/0	0.45 @ 2.5GHz 0.60 @ 3.8GHz	26 @ 2.5 GHz 19 @ 3.8 GHz	+33.5 dBm	+35 dBm	TB
UPG2409T6X	SPDT High Power for WiMAX, WLAN	+3.0/0	0.45 @ 2.5GHz 0.65 @ 6GHz	30 @ 2.5 GHz 27 @ 6 GHz	+34 dBm	+36 dBm	T6X
UPG2411T6R	SPDT Dual Band WLAN 802.11a/b/g, MIMO	+3.0/0 +1.8/0	0.5 @ 2.5GHz 0.6 @ 6GHz	25 @ 6GHz	+28dBm +23dBm	+30.5dBm +27dBm	T6R
UPG2411T7C	SPDT Dual Band WLAN 802.11a/b/g, MIMO	+3.0/0	0.5 @ 2.5GHz 0.7 @ 6GHz	20 @ 6GHz	-	+30.5 dBm	T7C
UPG2415TK	SPDT Dual Band WLAN 802.11a/b/g, MIMO	+3.0/0	0.45 @ 2.5GHz 0.65 @ 6GHz	28 @ 2.5 GHz 26 @ 6 GHz	+31 dBm	+34 dBm	TK
UPG2415T6X	SPDT Dual Band WLAN 802.11a/b/g, MIMO	+3.0/0	0.45 @ 2.5GHz 0.55 @ 6GHz	28 @ 2.5 GHz 26 @ 6 GHz	+31 dBm	+35 dBm	T6X
UPG2419T6R	SPDT, 2.4-6GHz TransferJet, Bluetooth Integrated capacitors	+3.0/0	0.45 @ 5GHz	17-26 @ 5GHz	-	+24dBm	T6R
UPG2422TK	SPDT Dual Band WLAN, 802.11a/b/g,n	+3.0/0	0.35 @ 2.5GHz, 0.55 @ 6GHz	28 @ 2.5GHz 24 @ 6GHz	+28dBm @ 2-6GHz	+31dBm @ 6GHz	TK
UPG2428T7F <sup>1</sup>	SPDT Dual Band WLAN 802.11a/b/g, MIMO	+3.0/0	0.45 @ 2.5GHz 0.60 @ 6GHz	24 @ 2.5GHz 24 @ 6GHz	+28dBm	-	T7F

Notes: 1. Under development, please inquire

## MobileComm Antenna Switches

Part Number	Description	Ports	Control	Typical Performance at T <sub>A</sub> = 25°C, 50 ohms	Package Code	Package Style
UPG2193T6E	SP8T	3x WCDMA 3x GSM Rx 2x GSM Tx	SPI	0.4 dB Ins Loss @ GSM LB Tx 0.6 dB Ins Loss @ GSM HB Tx -80 dBc 2f <sub>0</sub> , 3f <sub>0</sub> @ GSM LB/HB Tx +110 dBm IIP2 @ WCDMA -ANT	T6E	20-pin TQFN
UPG2424T7E	SP10T	5x WCDMA 3x GSM Rx 2x GSM Tx	GPIO 4 Line	0.45 Ins Loss WCDMA LB 0.65 Ins Loss WCDMA HB 0.80 Ins Loss GSM LB 0.90 Ins Loss GSM HB -80 dBc 2f <sub>0</sub> , 3f <sub>0</sub> @ GSM LB/HB Tx -110 dBm IMD3	T7E	26-pin QFN

Note: Please check with CEL for details on other antenna switches and modules

# GaAs Devices: FETs, RFIC LNAs & Power Amplifiers

## Low Noise GaAs FETs, 100MHz to 20GHz Typical Specifications @ TA = 25°C

Part Number	Gate Length (μm)	Gate Width (μm)	Recommended Frequency Range (GHz)	Test Frequency (GHz)	NF/GA Bias		NF <sub>OPT</sub> (dB)	GA (dB)	Power Bias		P <sub>1dB</sub> (dBm)	Chip / Package Code	Chip / Package Description
					V <sub>DS</sub> (V)	I <sub>DS</sub> (mA)			V <sub>DS</sub> (V)	I <sub>DS</sub> (mA)			
NE3503M04	0.2	160	2 to 18	12	2.0	10	0.55	11.5	—	—	—	M04	Plastic SMD
NE3508M04	0.6	800	1 to 6	2	2.0	10	0.40	14.0	3.0	30	+18.0	M04	Plastic SMD
NE3509M04	0.6	400	1 to 6	2	2.0	10	0.45	17.5	3.0	20	+14.0	M04	Plastic SMD
NE3509M14	0.6	400	1 to 6	2	2.0	10	0.4	18.5	2.0	10	+11.0	M14	Plastic SMD
NE3510M04	0.6	280	1 to 6	2	2.0	10	0.35	19.0	3.0	30	+12.0	M04	Plastic SMD
NE3511S02	0.2	160	4 to 18	12	2.0	10	0.30	13.5	—	—	—	S02	Micro-X Plastic
NE3512S02	0.2	160	4 to 18	12	2.0	10	0.35	13.5	—	—	—	S02	Micro-X Plastic
NE3513M04	0.2	160	10 to 14	12	2.0	6	0.45	13.0	—	—	—	M04	Plastic SMD
NE3514S02	0.2	160	4 to 20	20	2.0	10	0.75	10.0	—	—	—	S02	Micro-X Plastic
NE3515S02	0.2	200	6 to 18	12	2.0	10	0.3	12.5	3.0	25	+14.0	S02	Micro-X Plastic
NE3516S02 <sup>1</sup>	0.2	160	6 to 18	12	2.0	10	0.35	14.0	—	—	—	S02	Plastic SMD
NE3517S03	—	160	10 to 26	20	2.0	10	0.7	13.5	3.0	15	+12.0	S03	Micro-X Plastic
NE3519M04	0.6	400	1 to 6	2	2.0	10	0.40	18.5	2.0	10	+11	M04	Plastic SMD
NE3520S03	—	160	10 to 26	20	2.0	10	0.65	13.5	—	—	—	S03	Micro-X Plastic

Notes: 1. Under development, please inquire

## GaAs RFIC Power Amplifiers for Handset and Wireless Applications

Part Number	ELECTRICAL CHARACTERISTICS (TA = 25°C)				Package Style	Description	Application
	Frequency Range (MHz)	Test Conditions	Output Power (dBm)	Power Added Efficiency (%)			
UPG2118K	410 to 2500	f = 915 MHz P <sub>IN</sub> = 0 dBm V <sub>D</sub> = 3.2 V	+31.5 TYP	50 TYP	K	3 stage E-Mode Power Amplifier IC	AMR, ISM
UPG2250T5N	868 to 2500	f = 2450 MHz P <sub>IN</sub> = 0 dBm V <sub>DD</sub> = 1.8 V	+20 TYP	55 TYP	T5N	1.8 to 3.5 V Power Amplifier IC	Bluetooth, ZigBee, ISM
	868 to 2500	f = 2450 MHz P <sub>IN</sub> = 0 dBm V <sub>DD</sub> = 3.0 V	+25 TYP	58 TYP			
UPG2251T6M	2400 to 2500	f = 2450 MHz P <sub>IN</sub> = -5 dBm V <sub>DD</sub> = 3.0 V	+25 TYP	47 TYP	T6M	3.0V Power Amplifier IC with internal matching	Bluetooth, ZigBee, ISM
UPG2301T5L	868 to 2500	f = 2450 MHz P <sub>IN</sub> = +4 dBm V <sub>CC</sub> = 3.3 V	+23 TYP	50 TYP	T5L	2 stage HBT Power Amplifier	Bluetooth, ZigBee, ISM
UPG2314T5N	868 to 2500	f = 2450 MHz P <sub>IN</sub> = 0 dBm V <sub>CC</sub> = 3 V	+20 TYP	50 TYP	T5N	Low current HBT, miniature package	Bluetooth, ZigBee, ISM

# GaAs Devices: Integrated Front End ICs

## Front End ICs for Handset and Wireless Applications

Part Number	ELECTRICAL CHARACTERISTICS (TA = 25°C)				Package Style	Description	Application
	Frequency Range (MHz)	Test Conditions	Output Power (dBm)	Power Added Efficiency (%)			
UPG2253T6S	2400 to 2500	f = 2450 MHz P <sub>IN</sub> = 0 dBm V <sub>DD</sub> = 3.0 V	+19 to +21 TYP	28 TYP	T6S	+19 to +21 dBm GaAs RFIC: PA, 2 SPDTs, filter, Tx/Rx bypass path	Bluetooth, ZigBee, ISM

# GaAs CATV Hybrid Amplifiers

## Push-Pull CATV Hybrid Amplifiers (V<sub>DD</sub> = 24V, Z<sub>S</sub> = Z<sub>L</sub> = 75 Ω)

Part Number	Frequency (MHz, min – max)	Gain (dB, min – max)	CTB <sup>1</sup> (dBc, max)	CSO <sup>1</sup> (dBc, max)	X-MOD <sup>1,2</sup> (dBc, max)	NF <sup>3</sup> (dB, max)	I <sub>DD</sub> (mA, max)
MC-7831	50 – 870	18.0 – 19.0	-57	-57	-50	7.0	240
MC-7831-HA	40 – 1000	18.0 – 19.0	-57	-57	-50	7.0	240
MC-7832	50 – 870	22.0 – 23.0	-57	-57	-50	6.5	240
MC-7832-HA	40 – 1000	22.0 – 23.0	-57	-57	-50	6.5	240
MC-7833	50 – 870	25.0 – 26.0	-57	-57	-50	6.0	240
MC-7834-KC <sup>4</sup>	50 – 870	20.0 – 21.0	-59	-59	-52	7.0	325
MC-7836	50 – 870	27.0 – 28.0	-58	-58	-52	6.0	260

Notes: 1. Distortion measurements at V<sub>OUT</sub> = 44 dBm V flat, 110 channels. 2. Measured using EIAJ methods and procedures.  
3. Noise Figure measured at 870 MHz. 4. Higher current device for better X-mod and crash point performance.

## Power Doubler CATV Hybrid Amplifiers (V<sub>DD</sub> = 24V, Z<sub>S</sub> = Z<sub>L</sub> = 75 Ω)

Part Number	Frequency (MHz, min – max)	Gain (dB, min – max)	CTB (dBc, typ)	CTB (dBc, max)	CSO (dBc, typ)	X-MOD <sub>1</sub> (dBc, typ)	X-MOD <sub>1</sub> (dBc, max)	I <sub>DD</sub> (mA, max)
MC-7845 <sup>2</sup>	50 – 870	18.0 – 19.0	-63	-60	-68	-59	-63	375
MC-7846 <sup>2</sup>	50 – 870	22.0 – 23.0	-63	-60	-67	-60	-63	375
MC-7847 <sup>2</sup>	50 – 870	25.0 – 26.0	-65	-60	-67	-62	-63	375
MC-7847-KC <sup>3</sup>	50 – 870	25.0 – 26.0	–	-60	–	–	-63	420
MC-7881 <sup>4</sup>	50 – 870	18.0 – 19.0	–	-60	–	–	-63	360
MC-7882 <sup>4</sup>	50 – 870	20.0 – 21.0	–	-60	–	–	-63	360
MC-7883 <sup>4</sup>	50 – 870	22.0 – 23.0	–	-60	–	–	-63	360
MC-7884 <sup>4</sup>	50 – 870	25.0 – 26.0	–	-60	–	–	-63	360
MC-7891 <sup>5</sup>	40 – 1000	18.0 – 19.5	–	-63	–	–	-65	385
MC-7893 <sup>5</sup>	40 – 1000	22.5 – 24.0	–	-63	–	–	-65	385
MC-7894 <sup>5</sup>	40 – 1000	24.5 – 25.5	–	-63	–	–	-65	385
MC-7896 <sup>5</sup>	40 – 1000	27.0 – 28.0	–	-63	–	–	-65	385

Notes: 1. Measured using EIAJ methods and procedures.  
2. Distortion measurements are made with 110 channels loading, V<sub>OUT</sub> = +50dBmV at 745.25 MHz, 10dB tilted across the band.  
3. Higher current device for better X-mod and crash point performance.  
4. Distortion measurements are made with 110 channels loading, V<sub>OUT</sub> = +52dBmV at 745.25 MHz, 10dB tilted across the band.  
5. Distortion measurements are made with 77 channels loading, V<sub>OUT</sub> = +52dBmV at 547.25 MHz, 7 dB tilted across the band.

# Silicon LD-MOSFET Power Devices

Silicon LD-MOSFETs Typical Specifications @ Tc = 25°C

Part Number	P <sub>OUT</sub> (dBm) TYP	Linear Gain (dB) TYP	Test Conditions				Package Description
			Freq (GHz)	P <sub>IN</sub> (dBm)	V <sub>DS</sub> (V)	I <sub>DSO</sub> (mA)	
NE552R479A	+26.0	11	2.45	+19	3.0	200	79A Pkg: Compact SMT
NE5511279A	+40.0	15.0	0.9	+27	7.5	400	79A Pkg: Compact SMT
NE5520279A	+32.0	10	1.8	+25	3.2	700	79A Pkg: Compact SMT
NE5520379A	+35.5	16	0.9	+25	3.2	600	79A Pkg: Compact SMT
	+33.0	8.5	1.8				
NE5531079A	+40.0	20.5	0.46	+25	7.5	200	79A Pkg: Compact SMT
NE55410GR	+40.4	25	2.1	+16	28	120	GR Pkg: 16 pin plastic HTSSOP
NE5500234	+32.5	11	1.9	+25	4.8	400	34 Pkg: Compact SMT
NE5500434	+35.0	14	0.9	+25	4.8	600	34 Pkg: Compact SMT
NE5550979A <sup>1</sup>	+39.4	22	0.46	+25	7.5	200	79A Pkg: Compact SMT

Notes: 1. Under development, please inquire

# Small Signal Silicon Bipolar Transistors

## Silicon Transistors

Part Number	TEST f (GHz)	NF/GA		NF TYP (dB)	GA TYP (dB)	MAG/MSG			f <sub>T</sub> TYP (GHz)	h <sub>FE</sub> TYP	I <sub>C</sub> MAX (mA)	Package Description
		V <sub>CE</sub> (V)	I <sub>CO</sub> (mA)			V <sub>CE</sub> (V)	I <sub>C</sub> (mA)	TYP (dB)				
NE661M04	2.0	2	2	1.2	16	2	10	22	22	100	10	M04 Pkg: 4 pin low profile SOT-343 style
NE662M04	2.0	2	5	1.1	16	2	20	20	23	70	35	M04 Pkg: 4 pin low profile SOT-343 style
NE662M16	2.0	2	5 / 20	1.1	17	2	20	19	25	70	35	M16 Pkg: 6 pin low profile, recessed leads
NE66219	2.0	2	5	1.5	12.0	2	20	14	21	80	35	19 Pkg: 3 pin Ultra-Super Mini Mold, SC-90 style
NE68018	2.0	6	5	1.8	10.0	1	1	12.5	10	100	35	18 Pkg: 4 pin Super Mini Mold
NE68019	2.0	3	5	1.9	9.0	1	1	12.0	8	120	35	19 Pkg: 3 pin Ultra-Super Mini Mold, SC-90 style
NE68030	2.0	6	5	1.7	9.5	6	10	8.5	10	100	35	30 Pkg: 3 pin Super Mini Mold, SOT-323 style
NE68033	2.0	6	5	1.8	9.0	6	10	8.0	10	100	35	33 Pkg: 3 pin Mini Mold, SOT-23 style
NE68039	2.0	6	5	1.7	11.0	6	10	9.0	10	100	35	39 Pkg: 4 pin Mini Mold
NE68118	1.0	2.5	3	1.1	13.0	2.5	3	16.0	9	100	65	18 Pkg: 4 pin Super Mini Mold
NE68119	1.0	2.5	3	1.1	12.0	2.5	3	15.5	7	120	65	19 Pkg: 3 pin Ultra-Super Mini Mold, SC-90 style
NE68130	1.0	8	7	1.5	13.5	8	20	13.0	7	120	65	30 Pkg: 3 pin Super Mini Mold, SOT-323 style
NE68133	1.0	8	7	1.2	13.0	8	20	11.0	9	100	65	33 Pkg: 3 pin Mini Mold, SOT-23 style
NE68139	1.0	8	7	1.2	13.5	8	20	15.0	9	100	65	39 Pkg: 4 pin Mini Mold, SOT-143 style
NE68518	2.0	2.5	3	1.5	8.5	2.5	3	12.0	12	110	30	18 Pkg: 4 pin Super Mini Mold
NE68519	2.0	2.5	3	1.5	7.5	2.5	3	11.0	12	110	30	19 Pkg: 3 pin Ultra-Super Mini Mold, SC-90 style
NE68539	2.0	2.5	3	1.5	7.5	2.5	3	11.5	12	110	35	39 Pkg: 4 pin Mini Mold, SOT-143 style
NE68618	2.0	1	3	1.5	9	1	3	13	15	100	10	18 Pkg: 4 pin Super Mini Mold
NE68619	2.0	1	3	1.5	8.5	1	3	12.5	12	100	10	19 Pkg: 3 pin Ultra-Super Mini Mold, SC-90 style
NE68718	2.0	1	3	1.3	8	1	3	11	13	100	30	18 Pkg: 4 pin Super Mini Mold
NE68719	2.0	1	3	1.3	7.5	1	3	10	9	100	30	19 Pkg: 3 pin Ultra-Super Mini Mold, SC-90 style
NE851M13	2.0	1	10	1.9	5.5	1	5	4.0	6.5	120	100	M13 Pkg: 3 pin low profile, ultra-miniature
NE85618	1.0	2.5	3	1.4	11.0	2.5	3	14.0	6.5	120	100	18 Pkg: 4 pin Super Mini Mold
NE85619	1.0	2.5	3	1.5	10.0	2.5	3	13.5	4.5	120	100	19 Pkg: 3 pin Ultra-Super Mini Mold, SC-90 style
NE85630	1.0	10	7	1.3	12.0	10	20	12.0	4.5	110	100	30 Pkg: 3 pin Super Mini Mold, SOT-323 style
NE85633	1.0	10	7	1.4	9.0	10	20	11.5	7	120	100	33 Pkg: 3 pin Mini Mold, SOT-23 style
NE85639	1.0	10	7	1.5	13.5	10	20	13.0	7	120	100	39 Pkg: 4 pin Mini Mold, SOT-143 style
NE894M13	2.0	1	5	1.4	13	1	20	13.0	20	80	35	M13 Pkg: 3 pin low profile, ultra-miniature
NE97733	1.0	-8	-3	1.5	10.0	-8	-20	12.0	8.5	60	-50	33 Pkg: 3 pin Mini Mold, SOT-23 style (PNP)
NE97833	1.0	-10	-3	2.0	7.0	-10	-15	10.0	5.5	40	-50	33 Pkg: 3 pin Mini Mold, SOT-23 style (PNP)

# Small Signal & Medium Power Transistors, Cordless Phone Devices

## SiGe Transistors

Part Number	TEST f (GHz)	NF/GA		NF TYP (dB)	GA TYP (dB)	MAG/MSG			f <sub>T</sub> TYP (GHz)	h <sub>FE</sub> TYP	I <sub>C</sub> MAX (mA)	Package Description
		V <sub>CE</sub> (V)	I <sub>CQ</sub> (mA)			V <sub>CE</sub> (V)	I <sub>C</sub> (mA)	TYP (dB)				
NESG2021M05	2	2	3	0.9	18.0	3	10	22.5	25	195	35	M05 Pkg: 4 pin low profile SOT-343 style
NESG2021M05	5.2	2	3	1.3	10.0	—	—	—	—	195	35	M05 Pkg: 4 pin low profile SOT-343 style
NESG2021M16	2	2	3	0.9	18	3	10	22.5	25	190	35	M16 Pkg: 6 pin low profile, recessed leads
NESG2031M05	2	2	5	0.8	17.0	3	20	21.5	—	195	35	M05 Pkg: 4 pin low profile SOT-343 style
NESG2031M05	5.2	2	5	1.3	10.0	—	—	—	—	195	35	M05 Pkg: 4 pin low profile SOT-343 style
NESG2031M16	5.2	2	5	1.3	10	3	20	21.5	25	190	35	M16 Pkg: 6 pin low profile, recessed leads
NESG204619	2	1	3	0.8	11.0	—	—	—	18	180	40	19 Pkg: 3 pin Ultra-Super Mini Mold, SC-90 style
NESG2101M16	2	2	10	0.9	13.0	3	50	17.0	17	190	100	M16 Pkg: 6 pin low profile, recessed leads
NESG210719	2	1	5	0.9	9.0	—	—	—	10	180	100	19 Pkg: 3 pin Ultra-Super Mini Mold, SC-90 style
NESG3031M05	5.2	2	6	0.95	10.0	—	—	—	—	300	35	M05 Pkg: 4 pin low profile SOT-343 style
NESG3031M05	5.8	2	6	1.1	9.5	3	20	14.0	—	300	35	M05 Pkg: 4 pin low profile SOT-343 style
NESG3031M14	5.2	2	6	0.95	10.0	—	—	—	—	300	35	M14 Pkg: 4 pin low profile, recessed leads
NESG3031M14	5.8	2	6	1.1	9.5	3	20	15.0	—	300	35	M14 Pkg: 4 pin low profile, recessed leads
NESG3032M14	2.0	2	6	0.6	17.5	3	20	20.5	—	300	35	M14 Pkg: 4 pin low profile, recessed leads
NESG3033M14	2.0	2	6	0.6	17.5	3	20	20.5	—	300	35	M14 Pkg: 4 pin low profile, recessed leads
NESG4030M14	5.8	2	6	1.1	11.5	—	—	—	—	400	35	M14 Pkg: 4 pin low profile, recessed leads
NESG7030M04 <sup>1</sup>	5.8	2	5	0.75	14	2	15	17.5	—	320	30	M04 Pkg: 4 pin low profile SOT-343 style

Notes: 1. Under development, please inquire

## Medium Power Silicon Transistors

Part Number	TEST f (GHz)	P <sub>1dB</sub>			MAG / MSG			f <sub>T</sub> TYP (GHz)	h <sub>FE</sub> TYP	I <sub>C</sub> MAX (mA)	Package Description
		V <sub>CE</sub> (V)	I <sub>CQ</sub> (mA)	TYP (dBm)	V <sub>CE</sub> (V)	I <sub>C</sub> (mA)	TYP (dB)				
NE46134	1.0	12.5	100	27.5	10	50	9	5.5	100	250	34 Pkg: 4 pin SOT-89 style
NE461M02	1.0	12.5	100	27.5	10	50	11	5.5	120	250	M02 Pkg: 4 pin high gain SOT-89 style
NE663M04	2.0	2	50	16	2	50	15	18	100	100	M04 Pkg: 4 pin low profile SOT-343 style
NE664M04	1.8	3.6	200	26	3	100	12	20	60	500	M04 Pkg: 4 pin low profile SOT-343 style
NE677M04	1.8	2.8	23	15	3	20	16	15	120	50	M04 Pkg: 4 pin low profile SOT-343 style
NE678M04	1.8	2.8	40	18	3	30	13.5	12	120	100	M04 Pkg: 4 pin low profile SOT-343 style
NE85634	1.0	10	40	22	10	40	11	6.5	120	100	34 Pkg: 4 pin SOT-89 style
NE856M02	1.0	10	40	22	10	50	14	6.5	120	100	M02 Pkg: 4 pin high gain SOT-89 style
NESG2101M05 <sup>1</sup>	2.0	3.6	10	21	3	50	17	17.0	195	100	M05 Pkg: 4 pin low profile SOT-343 style
NESG250134 <sup>1</sup>	0.5	3.6	3.6	29	3.6	100	23	10	120	500	34 Pkg: 4 pin SOT-89 style
NESG250134 <sup>1</sup>	0.9	3.6	3.6	29	—	—	—	10	120	500	34 Pkg: 4 pin SOT-89 style
NESG260234 <sup>1</sup>	0.46	6.0	6.0	30	6	100	23	15	120	600	34 Pkg: 4 pin SOT-89 style
NESG260234 <sup>1</sup>	0.9	6.0	6.0	30	—	—	—	10	120	600	34 Pkg: 4 pin SOT-89 style
NESG270034 <sup>1</sup>	0.46	6.0	6.0	33.5	—	—	—	15	120	750	34 Pkg: 4 pin SOT-89 style
NESG270034 <sup>1</sup>	0.9	6.0	6.0	31.5	—	—	—	15	120	750	34 Pkg: 4 pin SOT-89 style
UPA901TU	5.8	3.6	3.6	19	3.6	52	25	—	120	300	TU Pkg: 8 pin Mini Mold

Note: 1. SiGe part

## Silicon Transistors For Cordless Phones

Part Number	Frequency Range	P <sub>1dB</sub> (dBm)	Linear Gain (dB)	Collector Efficiency (%)	V <sub>CE</sub> (V)	Frequency (MHz)	Package Description
NE68939	500-2000	24.5	8	62	3.6	1900	39 Pkg: 4 pin Mini Mold, SOT-143 style
NE69039	500-2000	27.5	6	72	3.6	1900	39 Pkg: 4 pin Mini Mold, SOT-143 style



# Silicon Transistors: Twin Packages, Chips, Oscillator & Switching Devices

## Twin Transistors

Part Number	TEST f (GHz)	NF/GA V <sub>CE</sub> (V)	NF/GA I <sub>C</sub> (mA)	NF TYP (dB)	GA TYP (dB)	MAG (dB)	IS <sub>21E1</sub> <sup>2</sup>			f <sub>T</sub> TYP (GHz)	h <sub>FE</sub> TYP	I <sub>C</sub> MAX (mA)	Pkg. Code	Package Style	Die
							V <sub>CE</sub> (V)	I <sub>C</sub> (mA)	TYP (dB)						

### Twin Transistors in a single package — Matched Die

UPA800T	2.0	3	5	1.9	9.0	12.0	3	5	7.5	8	120	35	S06	SOT-363	NE680
UPA801T	1.0	3	7	1.2	10.0	14.0	3	7	9.0	4.5	120	100	S06	SOT-363	NE856
UPA802T	1.0	3	7	1.4	14.0	16.0	3	7	12.0	7.0	100	65	S06	SOT-363	NE681
UPA806T	2.0	3	3	1.5	7.5	11.0	3	10	8.5	12.0	110	30	S06	SOT-363	NE685
UPA807T	2.0	2	3	1.5	10.0	13.5	2	7	9.0	13.0	100	10	S06	SOT-363	NE686
UPA808T	2.0	2	3	1.3	8.0	11.0	2	20	8.5	11.0	100	30	S06	SOT-363	NE687
UPA810T	1.0	3	7	1.2	10.0	14.0	3	7	9.0	4.5	120	100	S06	SOT-363	NE856
UPA811T	2.0	3	5	1.9	9.0	12.0	3	5	7.5	8	120	35	S06	SOT-363	NE680
UPA812T	1.0	3	7	1.4	14.0	16.0	3	7	12.0	7.0	100	65	S06	SOT-363	NE681
UPA828TD	2.0	2	3	1.3	10.0	11	2	20	8.5	11.0	100	30	TD	Miniature Recessed Leads	NE687
UPA895TD	2.0	1	10	1.9	9.0	10.0	1	15	5.5	5	120	100	TD	Miniature Recessed Leads	NE851

### Twin Transistors in a single package — Mixed Die

UPA861TD (Q1)	2.0	1	3	1.5	9	11	1	10	9	12	105	30	TD	Miniature Recessed Leads	NE687
(Q2)	2.0	1	5	1.4	12.5	13.5	1	20	13	20	75	35			NE894
UPA862TD (Q1)	2.0	3	3	1.5	9.5	12.5	3	10	8.5	12	110	30	TD	Miniature Recessed Leads	NE685
(Q2)	2.0	1	10	1.9	9	10	1	15	5.5	6.5	120	100			NE851
UPA863TD (Q1)	2.0	1	3	1.5	9	11	1	10	9	12	105	30	TD	Miniature Recessed Leads	NE687
(Q2)	2.0	1	10	1.9	9	10	1	15	5.5	6.5	120	100			NE851

## Silicon Transistor Chips

Part Number	TEST f (GHz)	NF/GA V <sub>CE</sub> (V)	NF/GA I <sub>C</sub> (mA)	NF TYP (dB)	GA TYP (dB)	MAG TYP (dB)	IS <sub>21E1</sub> <sup>2</sup>			f <sub>T</sub> TYP (GHz)	h <sub>FE</sub> TYP	I <sub>C</sub> MAX (mA)	Pkg. Code	Die
							V <sub>CE</sub> (V)	I <sub>C</sub> (mA)	TYP (dB)					
NE46100	1.0	10	50	2.0	7.0	9.8	10	100	10	5.5	100	250	00	NE461
NE66100	2.0	2	2	1.2	16.5	22.0	2	5	17	25	70	12	00	NE661
NE66200	2.0	2	5	1.1	16.0	19.0	2	20	17	25	70	35	00	NE662
NE66300	2.0	2	10	1.2	17.5	14.0	2	50	11	25	70	100	00	NE663
NE68000	4.0	6	5	2.6	8.0	12.5	6	10	9.0	10.0	100	35	00	NE680
NE68100	2.0	8	7	1.6	12.0	19	8	20	14.0	9.0	100	65	00	NE681
NE85600	2.0	10	7	2.1	10.0	16	10	20	9.0	7.0	120	100	00	NE856
NESG303100G	2.4/5.8	2	6	0.6/1.1	16.0/9.5	14	3	20	8.5	110	300	35	00	NESG3031

## Silicon Oscillator Transistors

Part Number	P <sub>osc</sub>				f <sub>T</sub> TYP (GHz)	h <sub>FE</sub> TYP	I <sub>C</sub> MAX (mA)	Pkg. Code	Package Description
	f (GHz)	V <sub>CE</sub> (V)	I <sub>C</sub> (mA)	TYP (W)					
NE58219	0.9	5.0	5.0	0.001	5.0	90	60	19	19 Pkg: 3 pin Ultra-Super Mini Mold, SC-90 style

## Silicon Switching Transistors

Part Number	C <sub>CB</sub> V <sub>CB</sub> (V)	C <sub>CB</sub> TYP (pF)	f <sub>T</sub> TYP (GHz)	Typical Switching Times						IS <sub>21E1</sub> <sup>2</sup>				h <sub>FE</sub> TYP	I <sub>C</sub> MAX (mA)	Pkg. Code	Package Description
				V <sub>CE</sub> (V)	I <sub>C</sub> (mA)	T <sub>d(ON)</sub> (ns)	T <sub>r</sub> (ns)	T <sub>d(OFF)</sub> (ns)	T <sub>f</sub> (ns)	f (GHz)	V <sub>CE</sub> (V)	I <sub>C</sub> (mA)	TYP (dB)				
NE68100	10	0.2	9.0	8	15	0.3	–	0.2	–	2.0	8	20	11.0	100	65	00	Chip
NE68118	10	.25	9.0	8	15	0.4	–	0.3	–	1.0	8	20	15.0	100	65	18	18 Pkg: 4 pin Super Mini Mold
NE68119	3	.45	7.0	8	15	0.6	–	0.5	–	1.0	3	7	12.0	100	65	19	19 Pkg: 3 pin SC-90 style
NE68133	10	.35	9.0	8	15	0.4	–	0.3	–	1.0	8	20	13.0	100	65	33	33 Pkg: 3 pin SOT-23 style

# Silicon RFICs: Low Power & Wideband Amplifiers

## Low Power Amplifiers

Part Number	Typical Frequency Range @ 3dB down (MHz)	ELECTRICAL CHARACTERISTICS <sup>1</sup> (T <sub>A</sub> = 25°C)											Package Code	Package Style	
		V <sub>CC</sub> (V)	I <sub>CC</sub> (mA)			NF (dB)	Gain (dB)			RL <sub>IN</sub> (dB)	RL <sub>OUT</sub> (dB)	P <sub>1dB</sub> (dBm)			ISOL (dB)
			MIN	TYP	MAX	TYP	MIN	TYP	MAX	TYP	TYP	TYP			TYP
UPC2745TB <sup>2</sup>	2700	3	5	7.5	10	6.0	9	12	14	11	5.5	-3.0	38	S06 / TB	SOT-363
UPC2746TB <sup>2</sup>	1500	3	5	7.5	10	4.0	16	19	21	13	8.5	-3.7	45	S06 / TB	SOT-363
UPC2747TB <sup>3</sup>	1800	3	3.8	5	7	3.3	9	12	14	14	10	-10.9	40	S06 / TB	SOT-363
UPC2748TB <sup>3</sup>	1500	3	4.5	6	8	2.8	16	19	21	11.5	8.5	-8.5	40	S06 / TB	SOT-363
UPC2749TB <sup>4</sup>	2900	3	4	6	8	4	13	16	18.5	10	13	-12.5	30	S06 / TB	SOT-363
UPC3237TK <sup>2</sup>	1000	3	3.5	5.0	7	1.4	13.0	15.3	17.5	10	14	-5.5	22	TK	6 pin Recessed Lead
UPC8151TB <sup>5</sup>	Note 6	3	2.8	4.2	5.8	6.0	9.5	12.5	14.5	5	10	+2.5	38	S06 / TB	SOT-363
UPC8179TK <sup>4</sup>	Note 7	3	2.9	4.0	5.4	5.0	13.0	15.5	17.5	7	-	0.5	42	TK	6 pin Recessed Lead

Notes: 1. Z<sub>L</sub> = 50 Ω for all Electrical Characteristics 2. f = 500 MHz test condition 3. f = 900 MHz test condition 4. f = 1900 MHz test condition  
5. f = 1000 MHz test condition 6. 100–1900MHz with output port matching 7. 100–2400MHz with output port matching

## Wideband Amplifiers

Part Number	Typical Frequency Range @ 3dB down (MHz)	ELECTRICAL CHARACTERISTICS <sup>1</sup> (T <sub>A</sub> = 25°C)											Package Code	Package Style	
		V <sub>CC</sub> (V)	I <sub>CC</sub> (mA)			NF (dB)	Gain (dB)			RL <sub>IN</sub> (dB)	RL <sub>OUT</sub> (dB)	P <sub>1dB</sub> (dBm)			ISOL (dB)
			MIN	TYP	MAX	TYP	MIN	TYP	MAX	TYP	TYP	TYP			TYP
UPC2708TB <sup>3</sup>	2900	5	20	26	33	6.5	13	15	18.5	11	20	+9.2	23	S06 / TB	SOT-363
UPC2709TB <sup>3</sup>	2300	5	19	25	32	5.0	21	23	26.5	10	10	+8.7	31	S06 / TB	SOT-363
UPC2710TB <sup>2</sup>	1000	5	16	22	29	3.5	30	33	36.5	6	12	+10.8	39	S06 / TB	SOT-363
UPC2711TB <sup>3</sup>	2900	5	9	12	15	5.0	11	13	16.5	25	12	-2.6	30	S06 / TB	SOT-363
UPC2712TB <sup>3</sup>	2600	5	9	12	15	4.5	18	20	23.5	12	13	-0.4	33	S06 / TB	SOT-363
UPC2762TB <sup>4</sup>	2900	3	-	27	35	7.0	11.5	15.5	17.5	8.5	12	+7	25	S06 / TB	SOT-363
UPC2763TB <sup>4</sup>	2700	3	-	27	35	5.5	18	21	24	11	9	+6.5	29	S06 / TB	SOT-363
UPC2776TB <sup>3</sup>	2700	5	18	25	33	6.0	21	23	26	7.5	20	+6	32	S06 / TB	SOT-363
UPC3215TB <sup>4</sup>	2900	5	-	14	-	2.3	18.5	20.5	-	15	9.5	+1.5	44	S06 / TB	SOT-363
UPC3223TB <sup>3</sup>	3200	5	15	19	24	4.5	20.5	23	22.5	12	12	+6.5	33	S06 / TB	SOT-363
UPC3224TB <sup>3</sup>	3200	5	7.0	9.0	12.0	4.3	19	21.5	24	12	17	-3.5	40	S06 / TB	SOT-363
UPC3225TB <sup>3</sup>	2800	5	20.0	24.5	31.0	3.7	30	32.5	35	8.5	10.5	+9.0	41	S06 / TB	SOT-363
UPC3226TB <sup>3</sup>	3200	5	12.5	15.5	19.5	5.3	22	24	26	14	13	+7.5	34	S06 / TB	SOT-363
UPC3227TB <sup>3</sup>	3200	5	4.0	4.8	6.0	4.7	20.5	22.5	24.5	10.5	13.5	-6.5	40	S06 / TB	SOT-363
UPC3232TB <sup>3</sup>	3200	5	20	26	32	4.0	30	32.8	35.5	9.5/13	10/14.5	+11	41	S06 / TB	SOT-363
UPC3236TK <sup>3</sup>	3000	5	19	24	31	2.6	36	38	41	9	11	+10	50	TK	6-pin Recessed Lead
UPC3239TB <sup>3</sup>	3000	3.3	23	29	37	4.2	22	25	28	15	25	+9	35	S06 / TB	SOT-363
UPC3240TB <sup>3</sup>	3000	3.3	9.5	13	17	4.3	22	25	28	23	12	+1	42	S06 / TB	SOT-363
UPC3241TB <sup>3</sup>	3000	3.3	15	19.8	25	4.0	20.5	23.5	26.5	20	17	+7.5	32	S06 / TB	SOT-363
UPC3242TB <sup>3,6</sup>	3000	3.3	-	4.3	-	3.5	-	22	-	10	10	+10.5	-	S06 / TB	SOT-363
UPC3244TB	2900	3.3	14.5	18	22	3.1	26.5	29.5	32.5	12	12	+7.0	40	S06 / TB	SOT-363
UPC8181TB <sup>4</sup>	4000	3	-	23	30	4.5	18	21	24	10.5	10	+7	32	S06 / TB	SOT-363
UPC8182TB <sup>4</sup>	2900	3	22	30	38	4.5	17.5	20.5	23.5	0	11	+9.0	32	S06 / TB	SOT-363

Notes: 1. Z<sub>L</sub> = 50 Ω for all Electrical Characteristics 2. f = 500 MHz test condition 3. f = 1000 MHz test condition 4. f = 1900 MHz test condition  
5. f = 900 MHz test condition 6. Under development, please inquire

# Silicon RFICs: Low Noise, AGC & Variable Gain Amplifiers

## SiGe and SiGe:C Low Noise Amplifiers

Part Number	Typical Frequency (GHz)	ELECTRICAL CHARACTERISTICS <sup>1</sup> (T <sub>A</sub> = 25°C)											Package Code	Package Style	
		V <sub>CC</sub> (V)	I <sub>CC</sub> (mA)			NF (dB)	Gain (dB)			RL <sub>IN</sub> (dB)	RL <sub>OUT</sub> (dB)	P <sub>1dB</sub> (dBm)			ISOL (dB)
			MIN	TYP	MAX	TYP	MIN	TYP	MAX	TYP	TYP	TYP			TYP
UPC8211TK <sup>1</sup>	3.0 <sup>2</sup>	3	—	3.5	4.5	1.3	15.5	18.5	21.5	-7.5	14.5	-24	32	TK	6 pin Recessed Lead
UPC8230TU <sup>3</sup>	1.575 <sup>2</sup>	3	—	6.0	—	0.85	—	18.5	—	-16	-15	-17	—	TU	8 pin Recessed Lead
UPC8231TK <sup>3</sup>	1.575 <sup>2</sup>	3	—	3.5	—	0.80	—	20.0	—	-13	-14	-22	—	TK	6 pin Recessed Lead
UPC8233TK <sup>3</sup>	1.575 <sup>2</sup>	1.8	—	3.5	—	0.95	—	20.0	—	-16	-16	-23	36	TK	6 pin Recessed Lead
UPC8236T6N <sup>3</sup>	1.575	1.8	—	6.5	—	0.8	—	19.5	—	-11	-14	-18	39	T6N	6 pin Leadless
UPC8240T6N <sup>3</sup>	1.575	3	4.5	6.5	9.0	1.0	24.5	28	31	8.5	17	-22.5	55	T6N	6 pin Leadless
UPC8244T6N <sup>3,4</sup>	1.575	3	3	6.5	10.0	0.8	16.5	18.5	20.5	10	17	-18.0	35	T6N	6 pin Leadless

Notes: 1. SiGe device 2. 0.8 to 3.0GHz 3. SiGe:C device 4. Under development, please inquire

## SiGe BiCMOS Wideband LNA with Bypass

Part Number	Mode	ELECTRICAL CHARACTERISTICS (T <sub>A</sub> = 25°C)											Package Code	Package Style
		Typical Frequency @ 3 dB Down (MHz)	V <sub>CC</sub> (V)	I <sub>CC</sub> (mA)	NF (dB)	Gain (dB)			RL <sub>IN</sub> (dB)	RL <sub>OUT</sub> (dB)	Input P <sub>1dB</sub> (dB)	Input IP <sub>3</sub> (dB)		
				TYP	TYP	MIN	TYP	MAX	TYP	TYP	TYP	TYP		
UPD5740T6N	LNA	770	2.8	5.0	1.5	11.5	13.5	15.5	10	11	-5.0	+2	T6N	8 pin SSOP
	Bypass	770		1μA	—	-2.0	-1.3	—	17.0	17.0	+8	+30		
UPD5750T7D	LNA	770	1.8	3.1	1.4	—	12.5	—	—	8	-11	-8	T7D	WL-BGA
	Bypass	770		1μA	—	—	-1.4	—	14	14	+8	+32		
UPD5756T6N	LNA	1000	3.3	25	3.2	10.5	13	15.5	10	12	+10	+9	T6N	8 pin SSOP
	Bypass	1000		1μA	—	—	—	—	—	—	—	+29		

## AGC Amplifiers with Video Output

Part Number	ELECTRICAL CHARACTERISTICS (T <sub>A</sub> = 25°C)											Package Code	Package Style	
	Typical Frequency @ 3 dB Down (MHz)	V <sub>CC</sub> (V)	I <sub>CC</sub> (mA)			NF (dB)	Gain (dB)		RL <sub>IN</sub> (dB)	RL <sub>OUT</sub> (dB)	V <sub>OUT</sub> <sup>2</sup> (p-p)			AGC (dB)
			MIN	TYP	MAX	TYP	MIN	MAX	TYP	TYP	TYP			TYP
UPC3217GV <sup>1</sup>	100	5	15	23	34	6.5	0	53	N/A	N/A	1.0	53	S08 / GV	8 pin SSOP
UPC3218GV <sup>1</sup>	100	5	15	23	34	3.5	10	63	N/A	N/A	1.0	53	S08 / GV	8 pin SSOP
UPC3219GV <sup>1</sup>	100	5	28	35	42	9	0	42	N/A	N/A	1.0	42	S08 / GV	8 pin SSOP
UPC3221GV <sup>1</sup>	100	5	26	33	41	4.2	10	60	N/A	N/A	1.0	50	S08 / GV	8 pin SSOP
UPC3231GV <sup>1</sup>	90	5	28	36	44	5.0	4	65	N/A	N/A	1.0	61	S08 / GV	8 pin SSOP
UPC3234GV <sup>1</sup>	100	5	—	28.5	38	4.0	4.5	63	N/A	N/A	1.0	58.5	S08 / GV	8 pin SSOP

Notes: 1. f<sub>IN</sub> = 45 MHz, Z<sub>S</sub> = 50Ω, Z<sub>L</sub> = 250Ω 2. Output Voltage swing into RL = 250Ω, V<sub>OUT</sub> = 1.0 V<sub>p-p</sub>

## Variable Gain Amplifiers

Part Number	ELECTRICAL CHARACTERISTICS (T <sub>A</sub> = 25°C)										Package Code	Package Style
	Typical Frequency @ 3 dB Down (MHz)	V <sub>CC</sub> (V)	I <sub>CC</sub> (mA)			NF (dB)	Gain (dB)		RL <sub>IN</sub> (dB)	RL <sub>OUT</sub> (dB)		
			MIN	TYP	MAX	TYP	MIN	MAX	TYP	TYP		
UPC3245TB <sup>1</sup>	250-3000	3.3	—	27.5	—	4.0 to 9.0	6.5	25	15	15	TB	SOT-363

Notes: 1. f = 2.5MHz, 50Ω in and out, -20dBm input power

# Silicon RFIC, Up/Down Converters, Tuners & Prescalers

## Frequency Upconverters

Part Number	ELECTRICAL CHARACTERISTICS (T <sub>A</sub> = 25°C)								Package Code	Package Style
	IF Input Frequency Range @3 dB Down (MHz)	RF Output Frequency Range (MHz)	V <sub>CC</sub> (V)	I <sub>CC</sub> (mA)	Conversion Gain (dB)	P <sub>SAT</sub> <sup>1</sup> (dBm)	Noise Figure (dB)	OIP <sub>3</sub>		
	TYP	TYP		TYP	TYP	TYP	TYP			
UPC8106TB <sup>2</sup>	50-400	400-2000	3.0	9.0	10.0	-2.0	8.5	+5.5	S06 / TB	SOT-363
UPC8172TB <sup>3</sup>	50-400	800-2500	3.0	9.0	8.5	0.0	10.4	+6.0	S06 / TB	SOT-363
UPC8187TB <sup>4</sup>	50-400	800-2500	3.0	15	11	+2.5	12	+10.0	S06 / TB	SOT-363

Notes: 1. P<sub>IN</sub> = 0 dBm 2. RF = 900 MHz, LO = 660 MHz, PLO = -5 dBm 3. RF = 1900 MHz, LO = 1660 MHz, PLOIN = -5 dBm  
4. RF = 1900 MHz, LO = 1780 MHz, PLO = -5 dBm

## Frequency Downconverters

Part Number	ELECTRICAL CHARACTERISTICS (T <sub>A</sub> = 25°C)								Package Code	Package Style
	RF Input Frequency Range @3 dB Down (MHz)	IF Output Frequency Range @3 dB Down (MHz)	V <sub>CC</sub> (V)	I <sub>CC</sub> (mA)	Conversion Gain (dB)	P <sub>SAT</sub> <sup>1</sup> (dBm)	Noise Figure (dB)	Test Condition (Note)		
	TYP	TYP		TYP	TYP	TYP	TYP			
UPC2756TB	100-2000	10-300	3.0	5.9	14	-12	13	3	S06 / TB	SOT-363
UPC2757TB	100-2000	20-300	3.0	5.6	13	-8	13	4	S06 / TB	SOT-363
UPC2758TB	100-2000	20-300	3.0	11	17	-4	13	4	S06 / TB	SOT-363
UPC8112TB	800-2000	100-300	3.0	8.5	13	-3	11.2	5	S06 / TB	SOT-363

Note: 1. AGC Amp and Mixer Block only

## Out-of-Band Tuners: Downconverter with AGC & Video Amplifiers for CATV/Settop Box

Part Number	ELECTRICAL CHARACTERISTICS (T <sub>A</sub> = 25°C)							Package Code	Package Style
	RF Input Frequency Range (MHz)	V <sub>CC</sub> (V)	I <sub>CC</sub> (mA)	Conversion Gain (dB)	Gain Control Range (dB)	Noise Figure (dB)	IM3 (dBc) Code		
	TYP		TYP	TYP	TYP				
UPC3220GR	30-250	5.0	42	33	46	7.0	55	GR / S16	16 pin SSOP
UPC3228T5S	20-800	5.0	85	28	70	8.3	57	T5S	32 pin QFN
UPC3243T7A	50-300	3.3	85	78	60	7.6	59	T7A	28 pin QFN

## Prescalers (Frequency Dividers)

Part Number	ELECTRICAL CHARACTERISTICS (T <sub>A</sub> = 25°C)								Divide Ratio	Package Code	Package Style
	f <sub>IN</sub> (GHz)		P <sub>IN</sub> (dBm)		P <sub>OUT</sub> <sup>1</sup> (dBm)	V <sub>CC</sub> (V)	I <sub>CC</sub> (mA)				
	MIN	MAX	MIN	MAX	TYP		MIN	MAX			
UPB1507GV	0.5	3.0	-15	+6	Note 1	5.0	12.5	26.5	64/128/256	S08 / GV	8 pin SSOP
UPB1508GV	0.5	3.0	-10	+10	-7	5.0	12 (TYP)		2	S08 / GV	8 pin SSOP
UPB1509GV	0.05	1.0	-20	-5	Note 2	2.2 to 5.5	5.3 (TYP)		2/4/8	S08 / GV	8 pin SSOP
UPB1510GV	0.5	3.0	-15	+6	-7	5.0	15 (TYP)		4	S08 / GV	8 pin SSOP

Notes: 1. Output voltage swing with CL = 8 pF, V<sub>OUT</sub> = 1.2 V<sub>p-p</sub> minimum 2. Output voltage swing with RL = 200 Ω, V<sub>OUT</sub> = 0.1 V<sub>p-p</sub> minimum

# Package Dimensions Units in mm

These dimensions are for the package only. For detailed dimensions including leads, please refer to the datasheet.

<p><b>18 Package</b> (1.25 x 2.0 x 0.9)</p> <p>Top View Side View</p>	<p><b>19 Package</b> (0.8 x 1.6 x 0.75)</p> <p>Top View Side View</p>	<p><b>30 Package</b> (1.25 x 2.0 x 0.9)</p> <p>Top View Side View</p>	<p><b>33 Package</b> (1.5 x 2.9 x 1.4)</p> <p>Top View Side View</p>
<p><b>34 Package</b> (2.5 x 4.5 x 1.5)</p> <p>Top View Side View</p>	<p><b>39 Package</b> (1.5 x 2.9 x 1.1)</p> <p>Top View Side View</p>	<p><b>79A Package</b> (4.2 x 4.4 x 0.9)</p> <p>Top View Side View Bottom View</p>	<p><b>GR / S16 SSOP Package</b> (5.5 x 4.4 x 1.44)</p> <p>Top View Side View</p>
<p><b>K Package / 20 Pin MLP</b> (4.15 x 4.15 x 0.9)</p> <p>Top View Side View Bottom View</p>	<p><b>M02 Package</b> (2.45 x 4.5 x 1.5)</p> <p>Top View Side View</p>	<p><b>M04 Package</b> (1.25 x 2.0 x 0.6)</p> <p>Top View Side View</p>	<p><b>M05 Package</b> (1.25 x 2.0 x 0.6)</p> <p>Top View Side View</p>
<p><b>M13 Package</b> (0.5 x 1.0 x 0.5)</p> <p>Top View Side View Bottom View</p>	<p><b>M14 Package</b> (0.8 x 1.2 x 0.5)</p> <p>Top View Side View</p>	<p><b>M16 Package</b> (0.8 x 1.2 x 0.5)</p> <p>Top View Side View</p>	<p><b>S02 / S03 Package</b> (2.6 x 2.6 x 1.5)</p> <p>Top View Side View</p>
<p><b>S08 / GV Package</b> (3.0 x 3.2 x 1.5)</p> <p>Top View Side View</p>	<p><b>T / TB / S06 Package</b> (1.25 x 2.0 x 0.9)</p> <p>Top View Side View</p>	<p><b>TD Package</b> (0.8 x 1.2 x 0.55)</p> <p>Top View Side View</p>	<p><b>TK Package</b> (1.1 x 1.5 x 0.55)</p> <p>Top View Side View Bottom View</p>
<p><b>TU Package</b> (2.0 x 2.0 x 0.5)</p> <p>Top View Side View Bottom View</p>	<p><b>T5K Package</b> (1.0 x 1.0 x 0.37)</p> <p>Top View Side View Bottom View</p>	<p><b>T5L/T6M Package</b> (2.0 x 2.0 x 0.37)</p> <p>Top View Side View Bottom View</p>	<p><b>T5N/T6N Package</b> (1.5 x 1.5 x 0.37)</p> <p>Top View Side View Bottom View</p>

# Package Dimensions Units in mm

These dimensions are for the package only. For detailed dimensions including leads, please refer to the datasheet.

**T5R Package** (3.5 x 2.5 x 0.55)

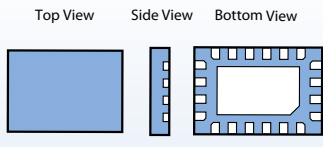

**T5S / QFN 32 Package** (5.0 x 5.0 x 0.75)

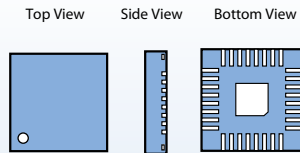

**T6C / QFN 16 Package** (3.0 x 3.0 x 0.75)

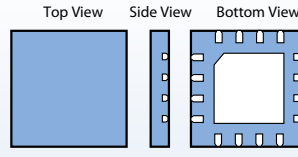

**T6E / RQFN 20 Package** (3.5 x 3.5 x 0.57)

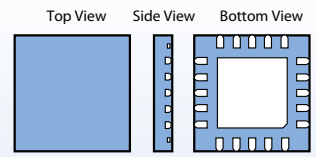

**T6Q / TSSOP 10 Package** (1.35 x 2.0 x 0.37)

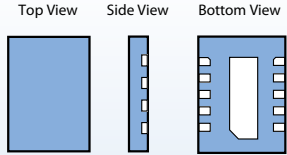

**T6R Package** (1.0 x 1.0 x 0.37)

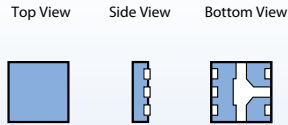

**T6S / QFN 16 Package** (3.0 x 3.0 x 0.75)

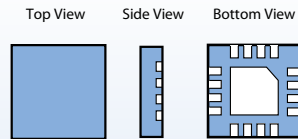

**T6X / TSON 6 Package** (1.5 x 1.5 x 0.37)

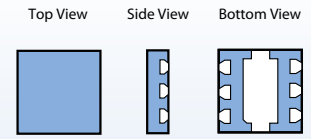

**T6Z / TSON 8 Package** (1.5 x 1.5 x 0.37)

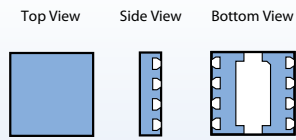

**T7A / QFN 28 Package** (5.0 x 5.0 x 0.72)

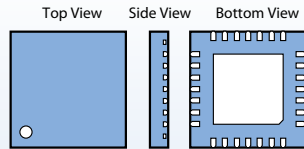

**T7C / RTSON 6 Package** (2.0 x 1.3 x 0.37)

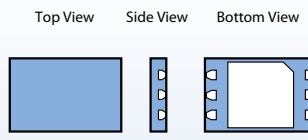

**T7E / QFN 26 Package** (3.8 x 3.0 x 0.575)

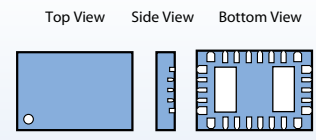

**T7F / TSQFN 6 Package** (1.0 x 1.0 x 0.37)

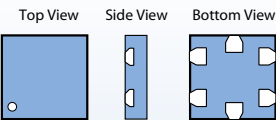

**T7D / WLBGA 6 Package** (0.73 x 0.48 x 0.07)

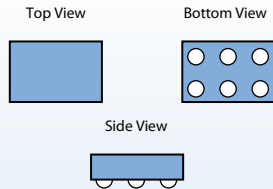







# **CEL** California Eastern Laboratories

## U.S. Sales Representatives

WA / OR / ID / MT / WY  
**Disman Bakner**  
Tel: (800) 347-3010

Colorado / Utah  
**Albright Engineering**  
Tel: (303) 877-9524

Southern CA - Irvine / LA  
**Centaur / Procyon**  
Tel: (949) 261-2123

Southern CA - San Diego  
**Centaur / Procyon**  
Tel: (858) 278-4950

Northern CA - Mountain View  
**TAARCOM**  
Tel: (650) 960-1550

Illinois  
**Stan Clothier Co.**  
Tel: (847) 781-4010

Iowa  
**Stan Clothier Co.**  
Tel: (319) 393-1576

Kansas  
**Stan Clothier Co.**  
Tel: (913) 894-1675

MN / ND / SD  
**Stan Clothier Co.**  
Tel: (952) 944-3456

Missouri  
**Stan Clothier Co.**  
Tel: (636) 916-3777

Wisconsin  
**Stan Clothier Co.**  
Tel: (608) 882-0686

Indiana / Kentucky  
**TMC**  
Tel: (317) 844-8462

Michigan  
**TMC**  
Tel: (248) 592-0814

Ohio / West PA  
**TMC**  
Tel: (513) 984-6720

TX / OK / AR / LA  
**TriStar Group**  
Tel: (972) 392-2848

CT / MA / ME / NH / RI / VT  
**Anchor Engineering**  
Tel: (508) 898-2724

North Carolina  
**Rep One**  
Tel: (919) 424-3814

South Carolina  
**Rep One**  
Tel: (704) 846-5744

GA / East TN  
**Rep One**  
Tel: (770) 209-9242

AL / West TN / MS  
**Rep One**  
Tel: (256) 539-7371

Southern Florida  
**Rep One**  
Tel: (561) 613-8342

Florida - Orlando  
**Rep One**  
Tel: (407) 952-9013

Florida - Tampa  
**Rep One**  
Tel: (813) 957-5293

Northern NJ / NYC / LI  
**Strategic Sales Inc.**  
Tel: (973) 808-5060

Southern NJ / East PA / DE  
**Strategic Sales Inc.**  
Tel: (856) 489-3883

MD / VA / WV  
**Strategic Sales Inc.**  
Tel: (410) 964-0097

## Canada

BC, Alberta,  
Saskatchewan  
**Disman Bakner**  
Tel: (800) 347-3010

Manitoba  
Ottawa & Eastern  
Ontario  
Quebec & Maritime  
Provinces  
**CEL West Sales**  
Tel: (408) 919-2639  
Fax: (408) 988-0279

Western & Central  
Ontario  
**E-Cubed Components**  
Tel: (905) 791-0812

## Mexico

Zapopan, Jalisco  
**Everest Sales & Solutions**  
Tel: +(52) 33-3123-0848

Ecatepec, EDO de  
Mexico, DF  
**Everest Sales & Solutions**  
Tel: +(52) 55-5770-2179

## South America

Brazil  
**VLA Solutions**  
Tel: +(55) 115-505-8011

## Africa/Middle East

South Africa  
**RF Design**  
Tel: 27 (0) 21-555-8400  
Fax: 27 (0) 21-555-8401

Israel  
**Semix Engineering**  
Tel: +(972) 3-910-9910  
Fax: +(972) 3-903-2068

## Asia

India  
**International Marketing  
Services**  
Tel: +(91) 80-2286-4005  
Fax: +(91) 80-2286-1979

Singapore  
**CEL Administrative Office**  
Tel: +(65) 6-560-3255

## CEL Headquarters

4590 Patrick Henry Drive  
Santa Clara, CA 95054  
Tel: (408) 919-2500  
Fax: (408) 988-0279

[www.cel.com](http://www.cel.com)

## CEL Regional Sales Offices

**CEL West**  
Tel: (408) 919-2639  
Fax: (408) 538-9000

**CEL Southwest**  
Tel: (760) 217-5190  
Fax: (408) 538-9000

**CEL Central**  
Tel: (408) 919-2619  
Fax: (913) 273-0741

**CEL South Central**  
Tel: (408) 919-2619  
Fax: (913) 273-0741

**CEL Southeast**  
Tel: (408) 919-2618  
Fax: (410) 558-6765

**CEL Northeast**  
Tel: (408) 919-2618  
Fax: (410) 558-6765

**CEL International**  
Tel: (408) 919-2615  
Fax: (908) 543-1013

**CEL Office for  
Distribution Partners**  
Tel: (408) 919-2500  
Fax: (408) 988-0279

## Distributors

**Arrow Electronics**  
[arrow.com](http://arrow.com)

**Avnet - Israel**  
[avnet-israel.com](http://avnet-israel.com)

**Digi-Key Corporation**  
[digikey.com](http://digikey.com)

**Future Electronics**  
[futureelectronics.com](http://futureelectronics.com)

**Mouser Electronics**  
[mouser.com](http://mouser.com)

**Nu Horizons**  
[nuhorizons.com](http://nuhorizons.com)