



Chipsmall Limited consists of a professional team with an average of over 10 year of expertise in the distribution of electronic components. Based in Hongkong, we have already established firm and mutual-benefit business relationships with customers from,Europe,America and south Asia,supplying obsolete and hard-to-find components to meet their specific needs.

With the principle of "Quality Parts,Customers Priority,Honest Operation,and Considerate Service",our business mainly focus on the distribution of electronic components. Line cards we deal with include Microchip,ALPS,ROHM,Xilinx,Pulse,ON,Everlight and Freescale. Main products comprise IC,Modules,Potentiometer,IC Socket,Relay,Connector.Our parts cover such applications as commercial,industrial, and automotives areas.

We are looking forward to setting up business relationship with you and hope to provide you with the best service and solution. Let us make a better world for our industry!



Contact us

Tel: +86-755-8981 8866 Fax: +86-755-8427 6832

Email & Skype: info@chipsmall.com Web: www.chipsmall.com

Address: A1208, Overseas Decoration Building, #122 Zhenhua RD., Futian, Shenzhen, China



EMIFIL® (RC Combined) Array

NFA31G Series (1206 Size)

■ Dimensions

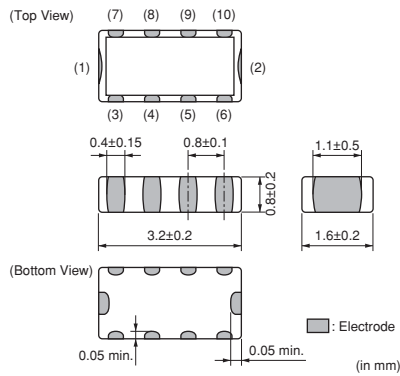

■ Equivalent Circuit

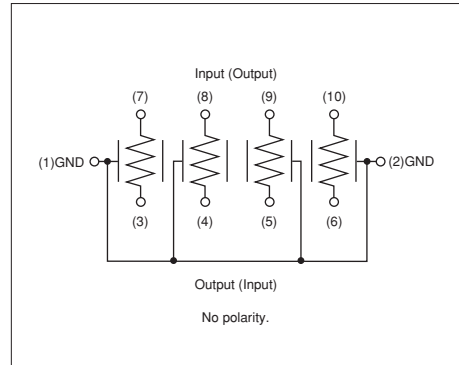

■ Insertion Loss Characteristics (Main Items)

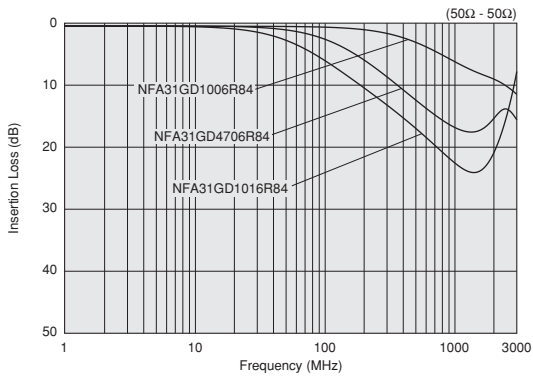

■ Insertion Loss Characteristics (Main Items)

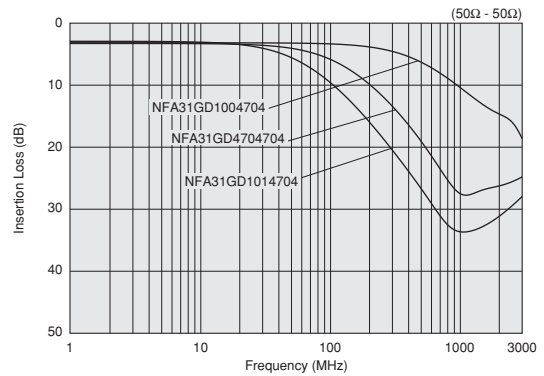

■ Insertion Loss Characteristics (Main Items)

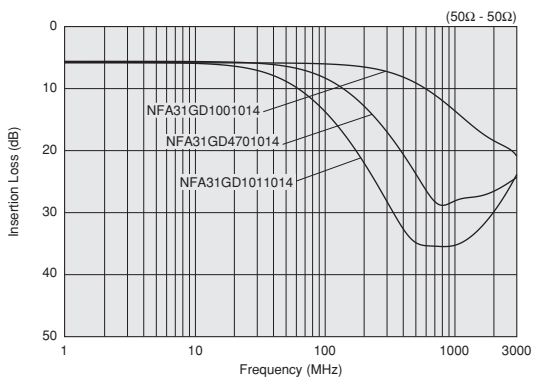

■ Insertion Loss Characteristics (Main Items)

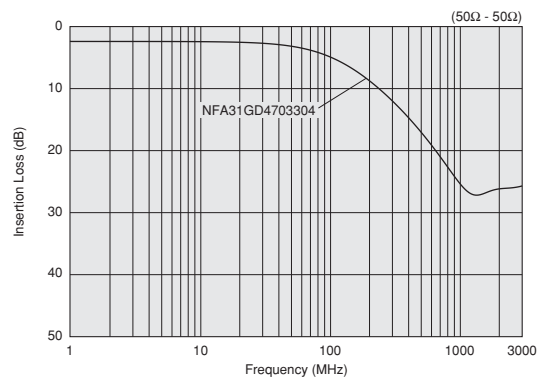

Continued on the following page.

● This data sheet is applied for RC Combined CHIP EMIFIL® used for General Electronics equipment for your design.

⚠ Note:

1. This datasheet is downloaded from the website of Murata Manufacturing co., ltd. Therefore, it's specifications are subject to change or our products in it may be discontinued without advance notice. Please check with our sales representatives or product engineers before ordering.
2. This datasheet has only typical specifications because there is no space for detailed specifications. Therefore, please approve our product specifications or transact the approval sheet for product specifications before ordering.

 Continued from the preceding page.

■ Packaging

Code	Packaging	Minimum Quantity
D	180mm Paper Tape	4000
B	Bulk(Bag)	100

■ Rated Value (□: packaging code)

Part Number	Capacitance	Resistance	Rated Current	Rated Voltage	Insulation Resistance (min.)	Operating Temperature Range
NFA31GD1006R84□	10pF ±20%	6.8ohm ±40%	50mA	6Vdc	1000M ohm	-40 to +85°C
NFA31GD1004704□	10pF ±20%	47ohm ±30%	20mA	6Vdc	1000M ohm	-40 to +85°C
NFA31GD1001014□	10pF ±20%	100ohm ±30%	15mA	6Vdc	1000M ohm	-40 to +85°C
NFA31GD4706R84□	47pF ±20%	6.8ohm ±40%	50mA	6Vdc	1000M ohm	-40 to +85°C
NFA31GD4703304□	47pF ±20%	33ohm ±30%	20mA	6Vdc	1000M ohm	-40 to +85°C
NFA31GD4704704□	47pF ±20%	47ohm ±30%	20mA	6Vdc	1000M ohm	-40 to +85°C
NFA31GD4701014□	47pF ±20%	100ohm ±30%	15mA	6Vdc	1000M ohm	-40 to +85°C
NFA31GD1016R84□	100pF ±20%	6.8ohm ±40%	50mA	6Vdc	1000M ohm	-40 to +85°C
NFA31GD1014704□	100pF ±20%	47ohm ±30%	20mA	6Vdc	1000M ohm	-40 to +85°C
NFA31GD1011014□	100pF ±20%	100ohm ±30%	15mA	6Vdc	1000M ohm	-40 to +85°C

Number of Circuit: 4

■ ⚠ Caution/Notice

⚠ Caution (Rating)

Do not use products beyond the rated current and rated voltage as this may create excessive heat and deteriorate the insulation resistance.

Notice

Solderability of Tin plating termination chip might be deteriorated when low temperature soldering profile where peak solder temperature is below the Tin melting point is used. Please confirm the solderability of Tin plating termination chip before use.

● This data sheet is applied for RC Combined CHIP EMIFIL® used for General Electronics equipment for your design.

⚠ Note:

1. This datasheet is downloaded from the website of Murata Manufacturing co., ltd. Therefore, it's specifications are subject to change or our products in it may be discontinued without advance notice. Please check with our sales representatives or product engineers before ordering.
2. This datasheet has only typical specifications because there is no space for detailed specifications. Therefore, please approve our product specifications or transact the approval sheet for product specifications before ordering.