



Chipsmall Limited consists of a professional team with an average of over 10 year of expertise in the distribution of electronic components. Based in Hongkong, we have already established firm and mutual-benefit business relationships with customers from,Europe,America and south Asia,supplying obsolete and hard-to-find components to meet their specific needs.

With the principle of "Quality Parts,Customers Priority,Honest Operation,and Considerate Service",our business mainly focus on the distribution of electronic components. Line cards we deal with include Microchip,ALPS,ROHM,Xilinx,Pulse,ON,Everlight and Freescale. Main products comprise IC,Modules,Potentiometer,IC Socket,Relay,Connector.Our parts cover such applications as commercial,industrial, and automotives areas.

We are looking forward to setting up business relationship with you and hope to provide you with the best service and solution. Let us make a better world for our industry!



## Contact us

Tel: +86-755-8981 8866 Fax: +86-755-8427 6832

Email & Skype: info@chipsmall.com Web: www.chipsmall.com

Address: A1208, Overseas Decoration Building, #122 Zhenhua RD., Futian, Shenzhen, China



# NGB8204N, NGB8204AN

## Ignition IGBT 18 Amps, 400 Volts

### N-Channel D<sup>2</sup>PAK

This Logic Level Insulated Gate Bipolar Transistor (IGBT) features monolithic circuitry integrating ESD and Overvoltage clamped protection for use in inductive coil drivers applications. Primary uses include Ignition, Direct Fuel Injection, or wherever high voltage and high current switching is required.

#### Features

- Ideal for Coil-on-Plug Applications
- Gate-Emitter ESD Protection
- Temperature Compensated Gate-Collector Voltage Clamp Limits Stress Applied to Load
- Integrated ESD Diode Protection
- New Design Increases Unclamped Inductive Switching (UIS) Energy Per Area
- Low Threshold Voltage to Interface Power Loads to Logic or Microprocessor Devices
- Low Saturation Voltage
- High Pulsed Current Capability
- Integrated Gate-Emitter Resistor ( $R_{GE}$ )
- Emitter Ballasting for Short-Circuit Capability
- These are Pb-Free Devices

#### MAXIMUM RATINGS ( $T_J = 25^\circ\text{C}$ unless otherwise noted)

Rating	Symbol	Value	Unit
Collector-Emitter Voltage	$V_{CES}$	430	$V_{DC}$
Collector-Gate Voltage	$V_{CER}$	430	$V_{DC}$
Gate-Emitter Voltage	$V_{GE}$	18	$V_{DC}$
Collector Current-Continuous @ $T_C = 25^\circ\text{C}$ - Pulsed	$I_C$	18 50	$A_{DC}$ $A_{AC}$
ESD (Human Body Model) $R = 1500 \Omega$ , $C = 100 \text{ pF}$	ESD	8.0	kV
ESD (Machine Model) $R = 0 \Omega$ , $C = 200 \text{ pF}$	ESD	800	V
Total Power Dissipation @ $T_C = 25^\circ\text{C}$ Derate above $25^\circ\text{C}$	$P_D$	115 0.77	W W/ $^\circ\text{C}$
Operating and Storage Temperature Range	$T_J$ , $T_{stg}$	-55 to +175	$^\circ\text{C}$

Stresses exceeding Maximum Ratings may damage the device. Maximum Ratings are stress ratings only. Functional operation above the Recommended Operating Conditions is not implied. Extended exposure to stresses above the Recommended Operating Conditions may affect device reliability.



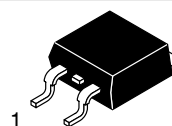
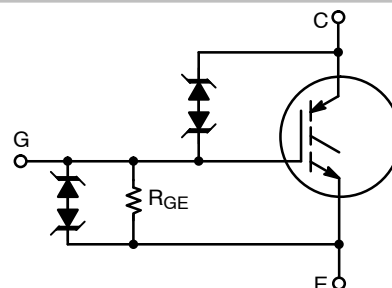
**ON Semiconductor**<sup>®</sup>

<http://onsemi.com>

**18 AMPS, 400 VOLTS**

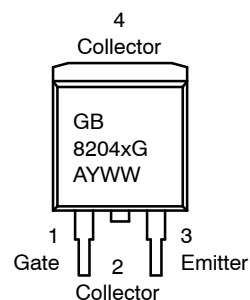
$V_{CE(on)} \leq 2.0 \text{ V @}$

$I_C = 10 \text{ A}$ ,  $V_{GE} \geq 4.5 \text{ V}$



**D<sup>2</sup>PAK  
CASE 418B  
STYLE 4**

#### MARKING DIAGRAM



GB8204x = Device Code  
x = N or A  
A = Assembly Location  
Y = Year  
WW = Work Week  
G = Pb-Free Package

#### ORDERING INFORMATION

Device	Package	Shipping <sup>†</sup>
NGB8204NT4G	D <sup>2</sup> PAK (Pb-Free)	800 / Tape & Reel
NGB8204ANT4G	D <sup>2</sup> PAK (Pb-Free)	800 / Tape & Reel

<sup>†</sup>For information on tape and reel specifications, including part orientation and tape sizes, please refer to our Tape and Reel Packaging Specifications Brochure, BRD8011/D.

# NGB8204N, NGB8204AN

## UNCLAMPED COLLECTOR-TO-EMITTER AVALANCHE CHARACTERISTICS ( $-55^{\circ} \leq T_J \leq 175^{\circ}C$ )

Characteristic	Symbol	Value	Unit
Single Pulse Collector-to-Emitter Avalanche Energy $V_{CC} = 50\text{ V}$ , $V_{GE} = 5.0\text{ V}$ , Pk $I_L = 21.1\text{ A}$ , $L = 1.8\text{ mH}$ , Starting $T_J = 25^{\circ}C$ $V_{CC} = 50\text{ V}$ , $V_{GE} = 5.0\text{ V}$ , Pk $I_L = 18.3\text{ A}$ , $L = 1.8\text{ mH}$ , Starting $T_J = 125^{\circ}C$	$E_{AS}$	400 300	mJ
Reverse Avalanche Energy $V_{CC} = 100\text{ V}$ , $V_{GE} = 20\text{ V}$ , Pk $I_L = 25.8\text{ A}$ , $L = 6.0\text{ mH}$ , Starting $T_J = 25^{\circ}C$	$E_{AS(R)}$	2000	mJ

## MAXIMUM SHORT-CIRCUIT TIMES ( $-55^{\circ}C \leq T_J \leq 150^{\circ}C$ )

Short Circuit Withstand Time 1 (See Figure 17, 3 Pulses with 10 ms Period)	$t_{sc1}$	750	$\mu s$
Short Circuit Withstand Time 2 (See Figure 18, 3 Pulses with 10 ms Period)	$t_{sc2}$	5.0	ms

## THERMAL CHARACTERISTICS

Characteristic	Symbol	Value	Unit
Thermal Resistance, Junction-to-Case	$R_{\theta JC}$	1.3	$^{\circ}C/W$
Thermal Resistance, Junction-to-Ambient D <sup>2</sup> PAK (Note 1)	$R_{\theta JA}$	50	$^{\circ}C/W$
Maximum Lead Temperature for Soldering Purposes, 1/8" from case for 5 seconds (Note 2)	$T_L$	275	$^{\circ}C$

- When surface mounted to an FR4 board using the minimum recommended pad size.
- For further details, see Soldering and Mounting Techniques Reference Manua, SOLDERRM/D.

## ELECTRICAL CHARACTERISTICS

Characteristic	Symbol	Test Conditions	Temperature	Min	Typ	Max	Unit
----------------	--------	-----------------	-------------	-----	-----	-----	------

### OFF CHARACTERISTICS

Collector-Emitter Clamp Voltage	$BV_{CES}$	$I_C = 2.0\text{ mA}$	$T_J = -40^{\circ}C$ to $150^{\circ}C$	380	395	420	$V_{DC}$
		$I_C = 10\text{ mA}$	$T_J = -40^{\circ}C$ to $150^{\circ}C$	390	405	430	
Zero Gate Voltage Collector Current	$I_{CES}$	$V_{CE} = 350\text{ V}$ , $V_{GE} = 0\text{ V}$	$T_J = 25^{\circ}C$	-	2.0	10	$\mu A_{DC}$
			$T_J = 150^{\circ}C$	-	10	40*	
			$T_J = -40^{\circ}C$	-	1.0	10	
Reverse Collector-Emitter Leakage Current	$I_{ECS}$	$V_{CE} = -24\text{ V}$	$T_J = 25^{\circ}C$	-	0.7	1.0	mA
			$T_J = 150^{\circ}C$	-	12	25*	
			$T_J = -40^{\circ}C$	-	0.1	1.0	
Reverse Collector-Emitter Clamp Voltage	$BV_{CES(R)}$	$I_C = -75\text{ mA}$	$T_J = 25^{\circ}C$	27	33	37	$V_{DC}$
			$T_J = 150^{\circ}C$	30	36	40	
			$T_J = -40^{\circ}C$	25	32	35	
Gate-Emitter Clamp Voltage	$BV_{GES}$	$I_G = 5.0\text{ mA}$	$T_J = -40^{\circ}C$ to $150^{\circ}C$	11	13	15	$V_{DC}$
Gate-Emitter Leakage Current	$I_{GES}$	$V_{GE} = 10\text{ V}$	$T_J = -40^{\circ}C$ to $150^{\circ}C$	384	640	700	$\mu A_{DC}$
Gate Emitter Resistor	$R_{GE}$	-	$T_J = -40^{\circ}C$ to $150^{\circ}C$	10	16	26	$k\Omega$

### ON CHARACTERISTICS (Note 3)

Gate Threshold Voltage	$V_{GE(th)}$	$I_C = 1.0\text{ mA}$ , $V_{GE} = V_{CE}$	$T_J = 25^{\circ}C$	1.1	1.4	1.9	$V_{DC}$
			$T_J = 150^{\circ}C$	0.75	1.0	1.4	
			$T_J = -40^{\circ}C$	1.2	1.6	2.1*	
Threshold Temperature Coefficient (Negative)	-	-	-	-	3.4	-	$mV/^{\circ}C$

\*Maximum Value of Characteristic across Temperature Range.

- Pulse Test: Pulse Width  $\leq 300\ \mu s$ , Duty Cycle  $\leq 2\%$ .

# NGB8204N, NGB8204AN

## ELECTRICAL CHARACTERISTICS

Characteristic	Symbol	Test Conditions	Temperature	Min	Typ	Max	Unit
<b>ON CHARACTERISTICS (Note 3)</b>							
Collector-to-Emitter On-Voltage	$V_{CE(on)}$	$I_C = 6.0\text{ A},$ $V_{GE} = 4.0\text{ V}$	$T_J = 25^\circ\text{C}$	1.0	1.4	1.6	$V_{DC}$
			$T_J = 150^\circ\text{C}$	0.9	1.3	1.6	
			$T_J = -40^\circ\text{C}$	1.1	1.45	1.7*	
		$I_C = 8.0\text{ A},$ $V_{GE} = 4.0\text{ V}$	$T_J = 25^\circ\text{C}$	1.3	1.6	1.9*	
			$T_J = 150^\circ\text{C}$	1.2	1.55	1.8	
			$T_J = -40^\circ\text{C}$	1.4	1.6	1.9*	
		$I_C = 10\text{ A},$ $V_{GE} = 4.0\text{ V}$	$T_J = 25^\circ\text{C}$	1.4	1.8	2.0	
			$T_J = 150^\circ\text{C}$	1.5	1.8	2.0	
			$T_J = -40^\circ\text{C}$	1.4	1.8	2.1*	
		$I_C = 15\text{ A},$ $V_{GE} = 4.0\text{ V}$	$T_J = 25^\circ\text{C}$	1.8	2.2	2.5	
			$T_J = 150^\circ\text{C}$	2.0	2.4	2.6*	
			$T_J = -40^\circ\text{C}$	1.7	2.1	2.5	
$I_C = 10\text{ A},$ $V_{GE} = 4.5\text{ V}$	$T_J = 25^\circ\text{C}$	1.3	1.8	2.0*			
	$T_J = 150^\circ\text{C}$	1.3	1.75	2.0*			
	$T_J = -40^\circ\text{C}$	1.4	1.8	2.0*			
Forward Transconductance	gfs	$V_{CE} = 5.0\text{ V},$ $I_C = 6.0\text{ A}$	$T_J = -40^\circ\text{C to } 150^\circ\text{C}$	8.0	14	25	Mhos

## DYNAMIC CHARACTERISTICS

Input Capacitance	$C_{ISS}$	$V_{CC} = 25\text{ V}, V_{GE} = 0\text{ V}$ $f = 1.0\text{ MHz}$	$T_J = -40^\circ\text{C to } 150^\circ\text{C}$	400	800	1000	pF
Output Capacitance	$C_{OSS}$			50	75	100	
Transfer Capacitance	$C_{RSS}$			4.0	7.0	10	

## SWITCHING CHARACTERISTICS

Turn-Off Delay Time (Resistive)	$t_{d(off)}$	$V_{CC} = 300\text{ V}, I_C = 6.5\text{ A}$ $R_G = 1.0\text{ k}\Omega, R_L = 46\ \Omega,$	$T_J = 25^\circ\text{C}$	-	4.0	10	$\mu\text{Sec}$
Fall Time (Resistive)	$t_f$	$V_{CC} = 300\text{ V}, I_C = 6.5\text{ A}$ $R_G = 1.0\text{ k}\Omega, R_L = 46\ \Omega,$	$T_J = 25^\circ\text{C}$	-	9.0	15	
Turn-On Delay Time	$t_{d(on)}$	$V_{CC} = 10\text{ V}, I_C = 6.5\text{ A}$ $R_G = 1.0\text{ k}\Omega,$ $R_L = 1.5\ \Omega$	$T_J = 25^\circ\text{C}$	-	0.7	4.0	$\mu\text{Sec}$
Rise Time	$t_r$	$V_{CC} = 10\text{ V}, I_C = 6.5\text{ A}$ $R_G = 1.0\text{ k}\Omega,$ $R_L = 1.5\ \Omega$	$T_J = 25^\circ\text{C}$	-	4.5	7.0	

\*Maximum Value of Characteristic across Temperature Range.

3. Pulse Test: Pulse Width  $\leq 300\ \mu\text{s}$ , Duty Cycle  $\leq 2\%$ .

# NGB8204N, NGB8204AN

## TYPICAL ELECTRICAL CHARACTERISTICS (unless otherwise noted)

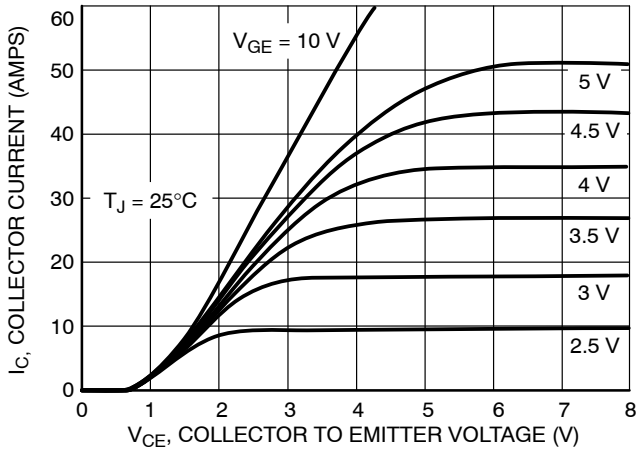


Figure 1. Output Characteristics

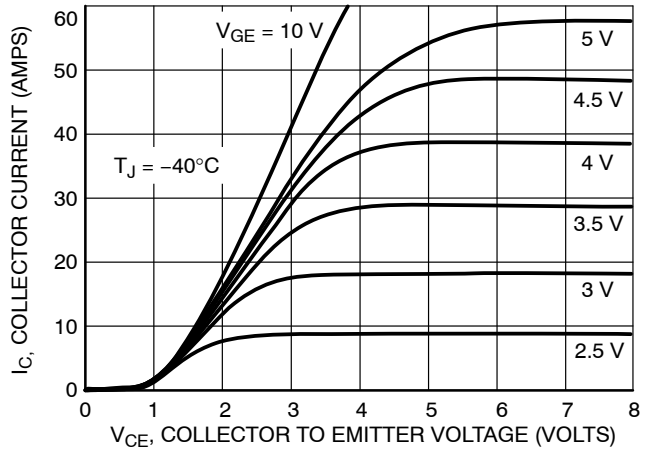


Figure 2. Output Characteristics

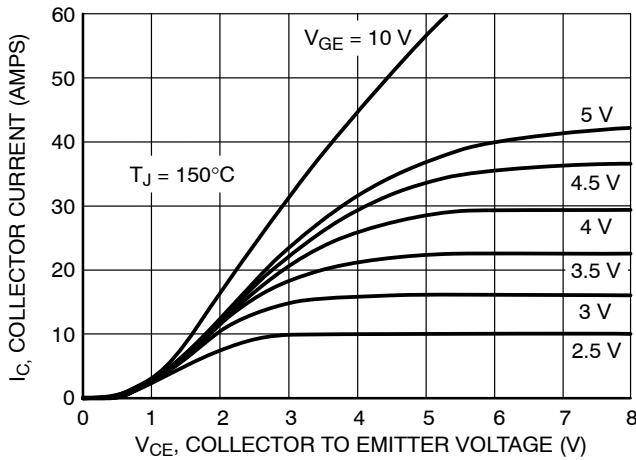


Figure 3. Output Characteristics

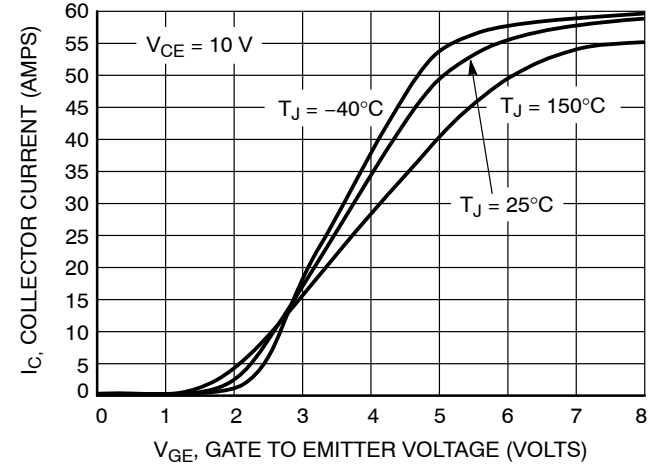


Figure 4. Transfer Characteristics

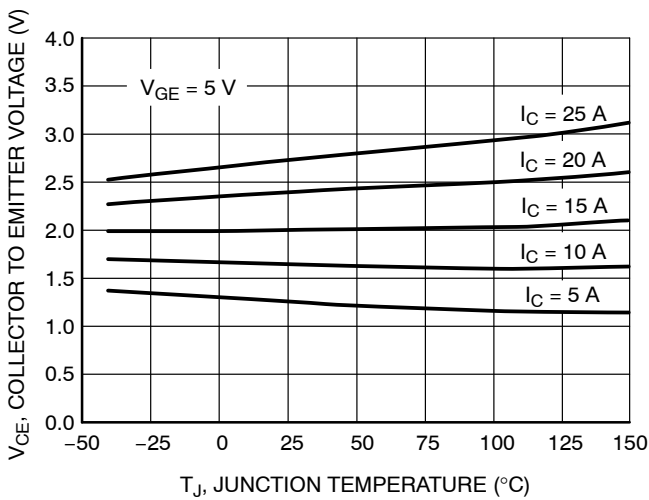


Figure 5. Collector-to-Emitter Saturation Voltage versus Junction Temperature

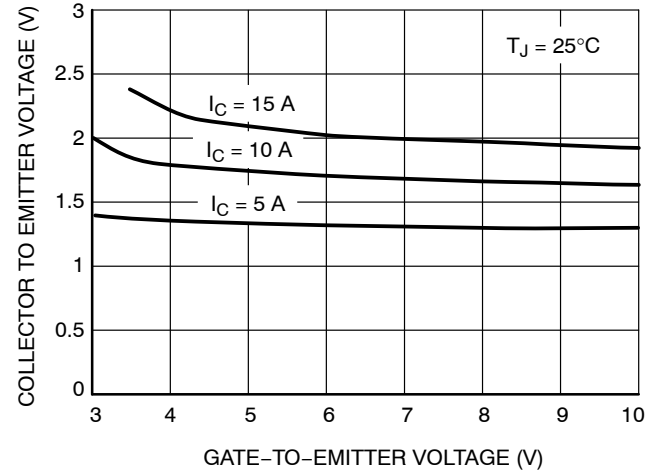
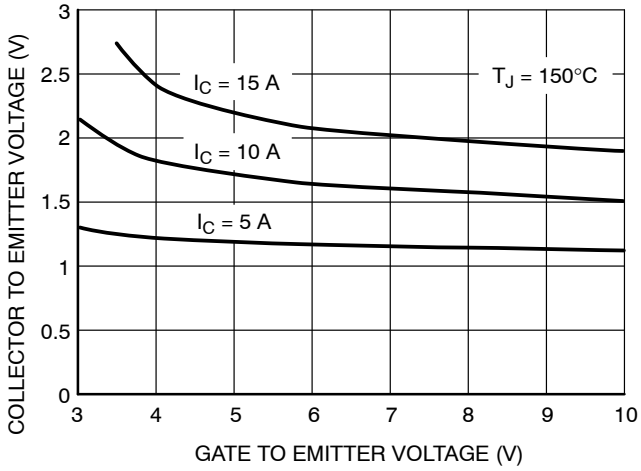
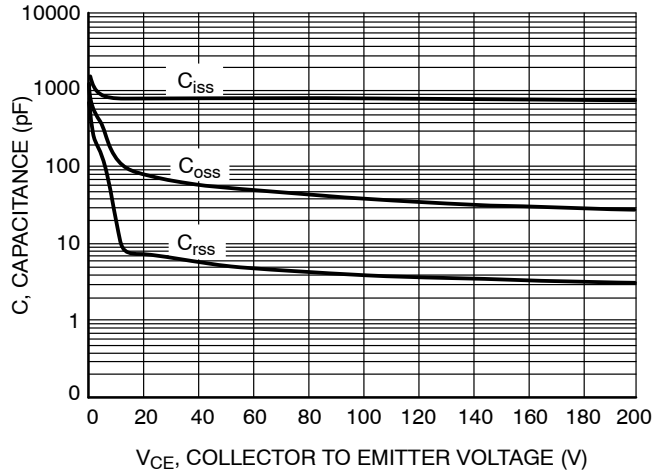


Figure 6. Collector-to-Emitter Voltage versus Gate-to-Emitter Voltage

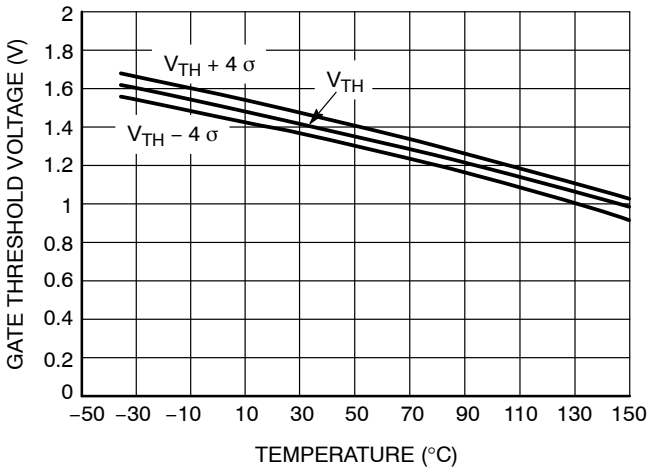
# NGB8204N, NGB8204AN



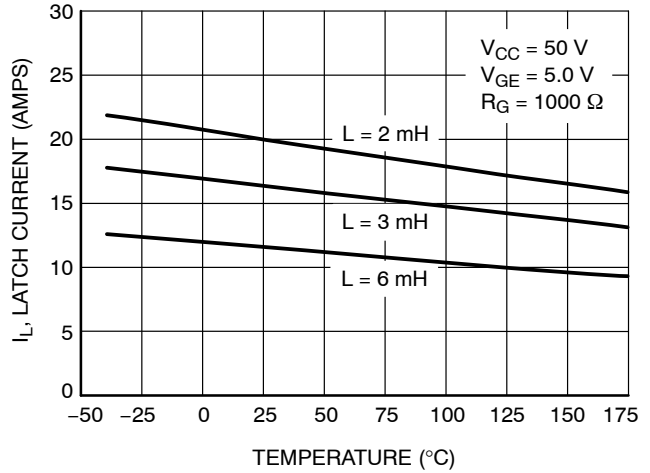
**Figure 7. Collector-to-Emitter Voltage versus Gate-to-Emitter Voltage**



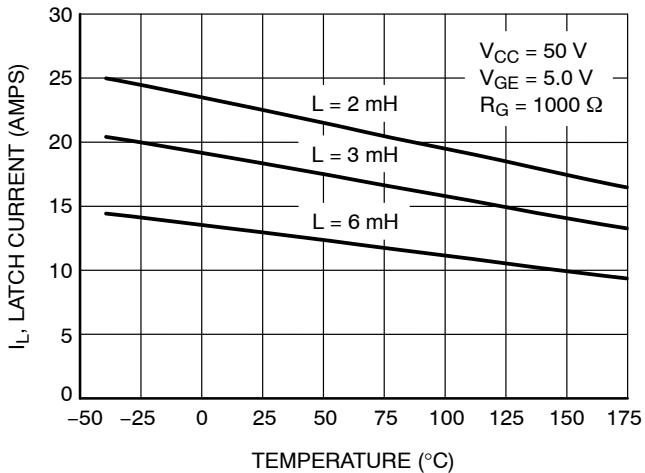
**Figure 8. Capacitance Variation**



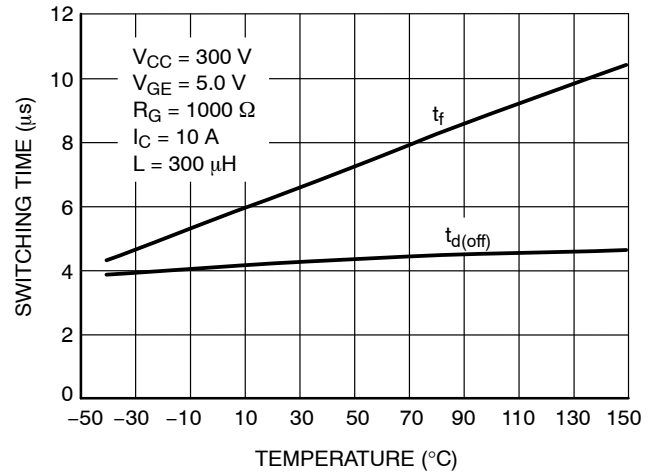
**Figure 9. Gate Threshold Voltage versus Temperature**



**Figure 10. Minimum Open Secondary Latch Current versus Temperature**

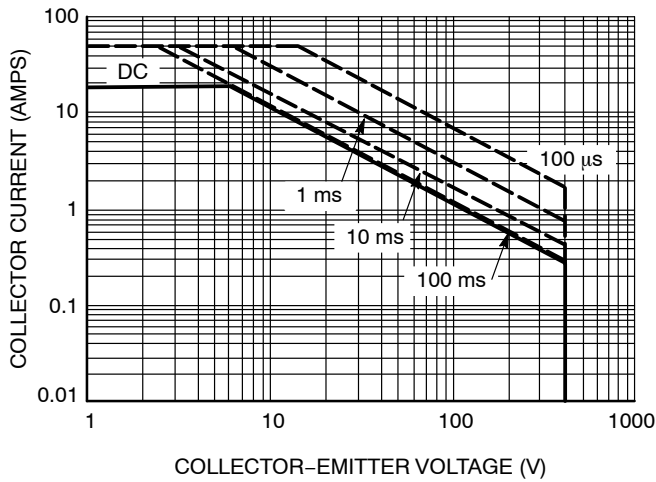


**Figure 11. Typical Open Secondary Latch Current versus Temperature**

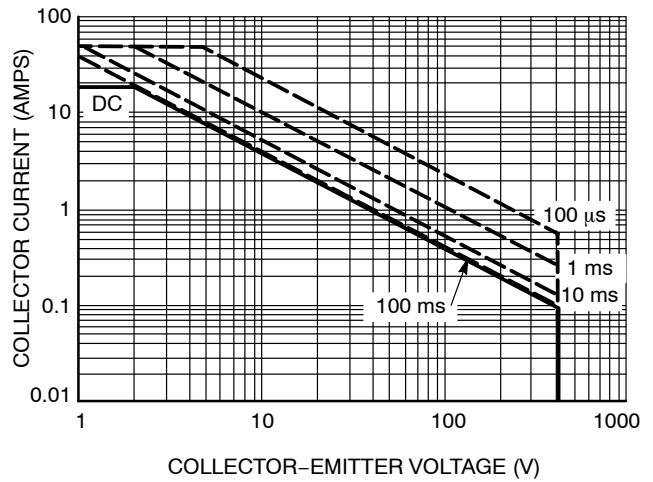


**Figure 12. Inductive Switching Fall Time versus Temperature**

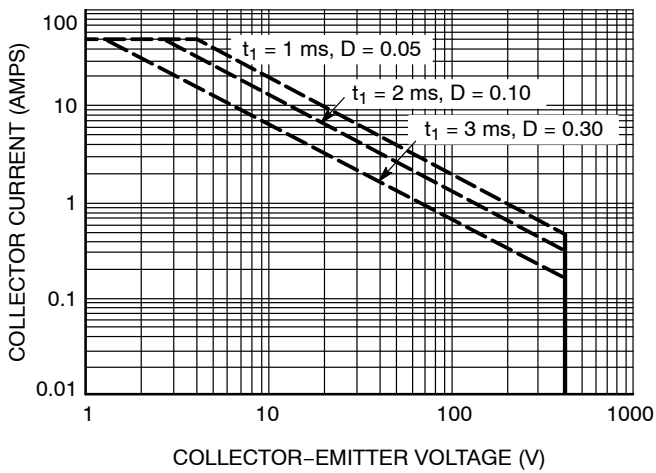
# NGB8204N, NGB8204AN



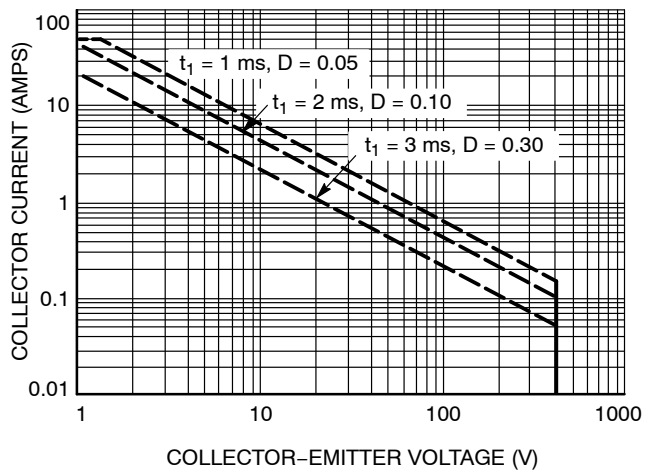
**Figure 13. Single Pulse Safe Operating Area (Mounted on an Infinite Heatsink at  $T_A = 25^\circ\text{C}$ )**



**Figure 14. Single Pulse Safe Operating Area (Mounted on an Infinite Heatsink at  $T_A = 125^\circ\text{C}$ )**



**Figure 15. Pulse Train Safe Operating Area (Mounted on an Infinite Heatsink at  $T_C = 25^\circ\text{C}$ )**



**Figure 16. Pulse Train Safe Operating Area (Mounted on an Infinite Heatsink at  $T_C = 125^\circ\text{C}$ )**

# NGB8204N, NGB8204AN

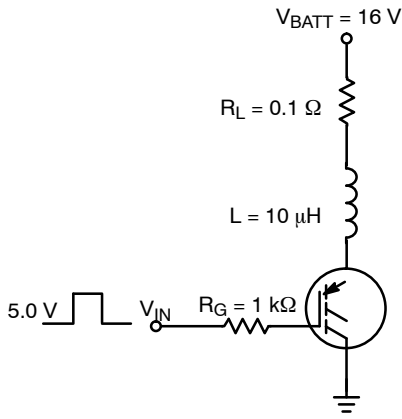


Figure 17. Circuit Configuration for Short Circuit Test #1

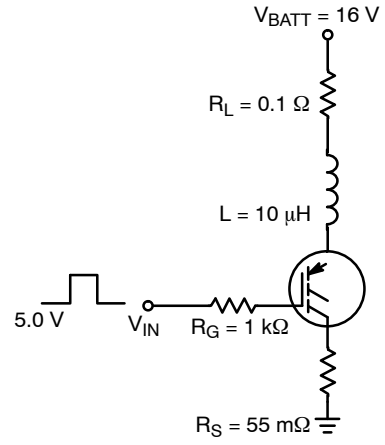


Figure 18. Circuit Configuration for Short Circuit Test #2

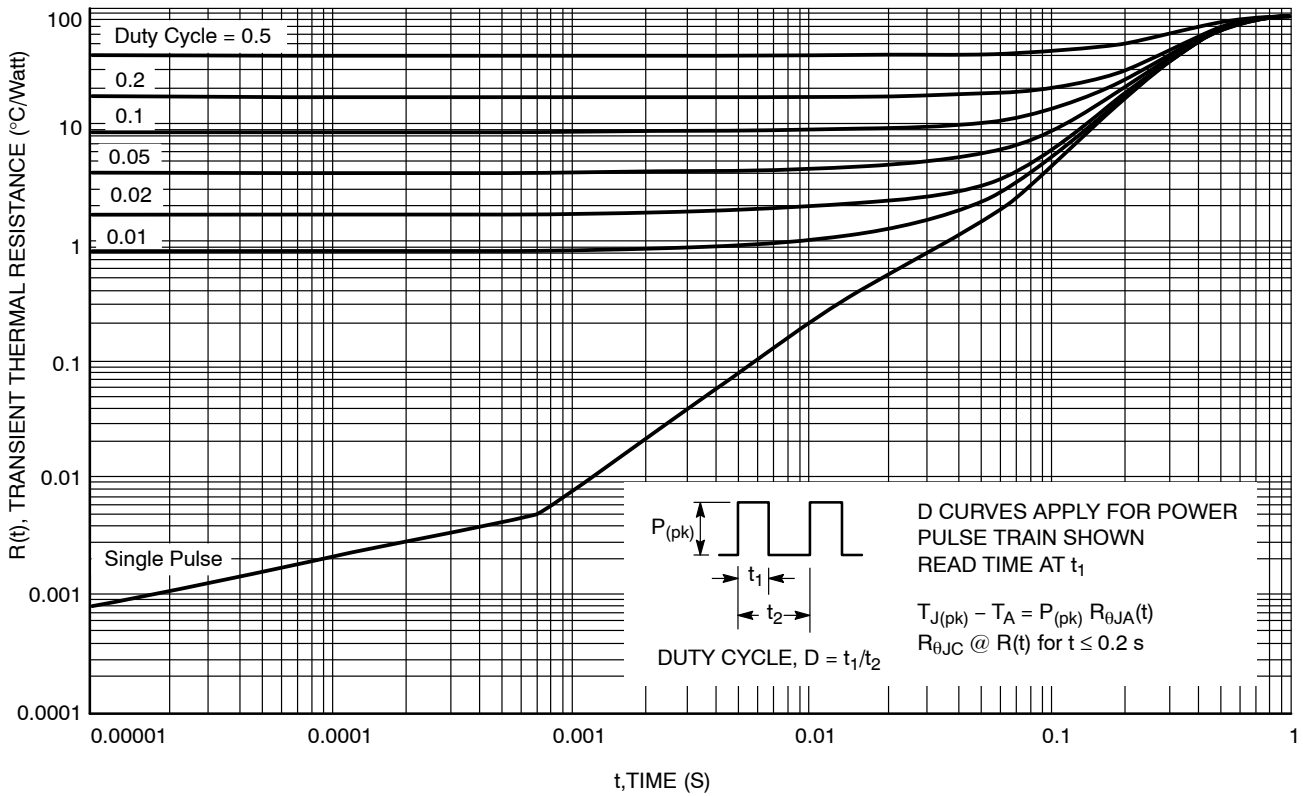


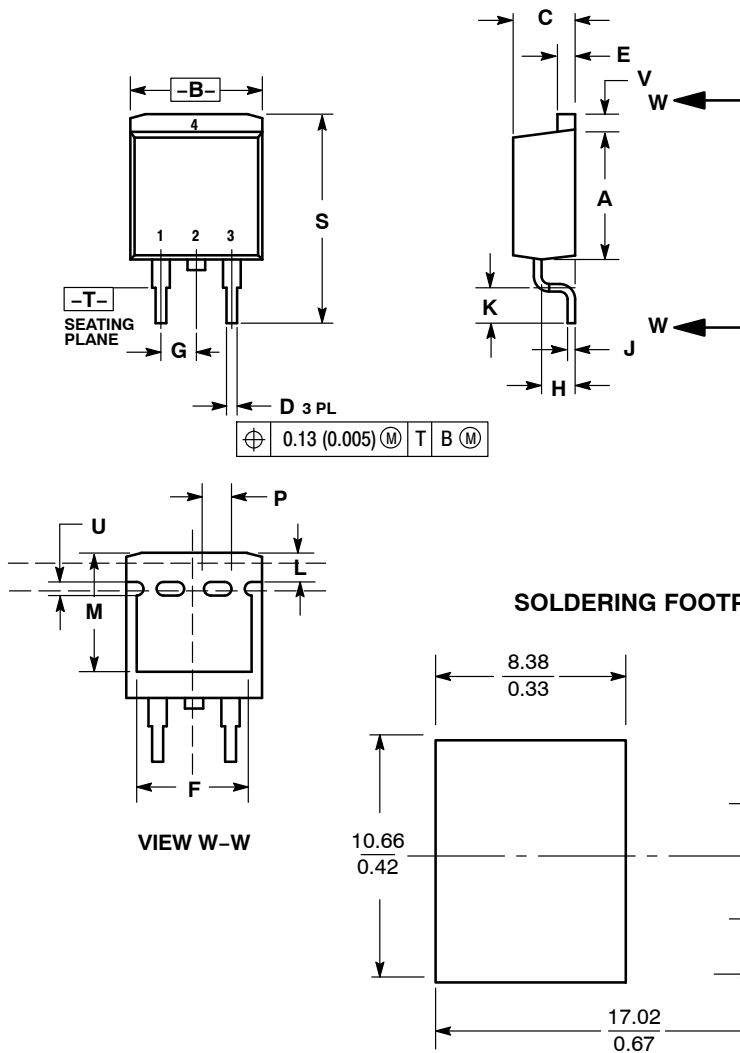
Figure 19. Transient Thermal Resistance (Non-normalized Junction-to-Ambient mounted on minimum pad area)



# NGB8204N, NGB8204AN

## PACKAGE DIMENSIONS

D<sup>2</sup>PAK 3  
CASE 418B-04  
ISSUE J

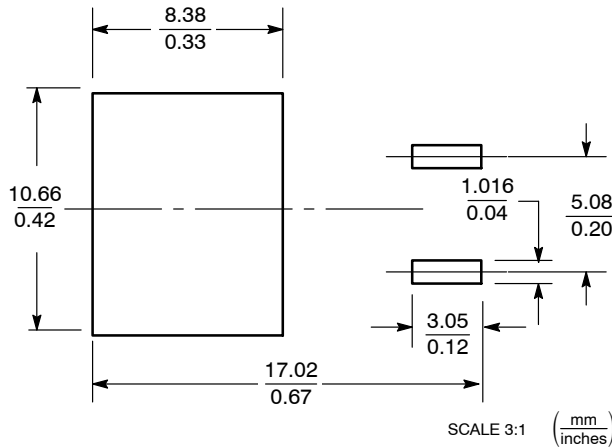


- NOTES:
1. DIMENSIONING AND TOLERANCING PER ANSI Y14.5M, 1982.
  2. CONTROLLING DIMENSION: INCH.
  3. 418B-01 THRU 418B-03 OBSOLETE, NEW STANDARD 418B-04.

DIM	INCHES		MILLIMETERS	
	MIN	MAX	MIN	MAX
A	0.340	0.380	8.64	9.65
B	0.380	0.405	9.65	10.29
C	0.160	0.190	4.06	4.83
D	0.020	0.035	0.51	0.89
E	0.045	0.055	1.14	1.40
F	0.310	0.350	7.87	8.89
G	0.100 BSC		2.54 BSC	
H	0.080	0.110	2.03	2.79
J	0.018	0.025	0.46	0.64
K	0.090	0.110	2.29	2.79
L	0.052	0.072	1.32	1.83
M	0.280	0.320	7.11	8.13
N	0.197 REF		5.00 REF	
P	0.079 REF		2.00 REF	
R	0.039 REF		0.99 REF	
S	0.575	0.625	14.60	15.88
V	0.045	0.055	1.14	1.40

- STYLE 4:  
PIN 1. GATE  
2. COLLECTOR  
3. EMITTER  
4. COLLECTOR

### SOLDERING FOOTPRINT\*



\*For additional information on our Pb-Free strategy and soldering details, please download the ON Semiconductor Soldering and Mounting Techniques Reference Manual, SOLDERRM/D.

ON Semiconductor and are registered trademarks of Semiconductor Components Industries, LLC (SCILLC). SCILLC reserves the right to make changes without further notice to any products herein. SCILLC makes no warranty, representation or guarantee regarding the suitability of its products for any particular purpose, nor does SCILLC assume any liability arising out of the application or use of any product or circuit, and specifically disclaims any and all liability, including without limitation special, consequential or incidental damages. "Typical" parameters which may be provided in SCILLC data sheets and/or specifications can and do vary in different applications and actual performance may vary over time. All operating parameters, including "Typicals" must be validated for each customer application by customer's technical experts. SCILLC does not convey any license under its patent rights nor the rights of others. SCILLC products are not designed, intended, or authorized for use as components in systems intended for surgical implant into the body, or other applications intended to support or sustain life, or for any other application in which the failure of the SCILLC product could create a situation where personal injury or death may occur. Should Buyer purchase or use SCILLC products for any such unintended or unauthorized application, Buyer shall indemnify and hold SCILLC and its officers, employees, subsidiaries, affiliates, and distributors harmless against all claims, costs, damages, and expenses, and reasonable attorney fees arising out of, directly or indirectly, any claim of personal injury or death associated with such unintended or unauthorized use, even if such claim alleges that SCILLC was negligent regarding the design or manufacture of the part. SCILLC is an Equal Opportunity/Affirmative Action Employer. This literature is subject to all applicable copyright laws and is not for resale in any manner.

### PUBLICATION ORDERING INFORMATION

**LITERATURE FULFILLMENT:**  
Literature Distribution Center for ON Semiconductor  
P.O. Box 5163, Denver, Colorado 80217 USA  
Phone: 303-675-2175 or 800-344-3860 Toll Free USA/Canada  
Fax: 303-675-2176 or 800-344-3867 Toll Free USA/Canada  
Email: orderlit@onsemi.com

**N. American Technical Support:** 800-282-9855 Toll Free  
USA/Canada  
**Europe, Middle East and Africa Technical Support:**  
Phone: 421 33 790 2910  
**Japan Customer Focus Center**  
Phone: 81-3-5817-1050

**ON Semiconductor Website:** [www.onsemi.com](http://www.onsemi.com)

**Order Literature:** <http://www.onsemi.com/orderlit>

For additional information, please contact your local Sales Representative