



Chipsmall Limited consists of a professional team with an average of over 10 year of expertise in the distribution of electronic components. Based in Hongkong, we have already established firm and mutual-benefit business relationships with customers from,Europe,America and south Asia,supplying obsolete and hard-to-find components to meet their specific needs.

With the principle of “Quality Parts,Customers Priority,Honest Operation,and Considerate Service”,our business mainly focus on the distribution of electronic components. Line cards we deal with include Microchip,ALPS,ROHM,Xilinx,Pulse,ON,Everlight and Freescale. Main products comprise IC,Modules,Potentiometer,IC Socket,Relay,Connector.Our parts cover such applications as commercial,industrial, and automotives areas.

We are looking forward to setting up business relationship with you and hope to provide you with the best service and solution. Let us make a better world for our industry!



Contact us

Tel: +86-755-8981 8866 Fax: +86-755-8427 6832

Email & Skype: info@chipsmall.com Web: www.chipsmall.com

Address: A1208, Overseas Decoration Building, #122 Zhenhua RD., Futian, Shenzhen, China



NH020-Series Power SIPs: 5 Vdc Input; 1.5 Vdc to 3.3 Vdc Output; 20 W

RoHS Compliant

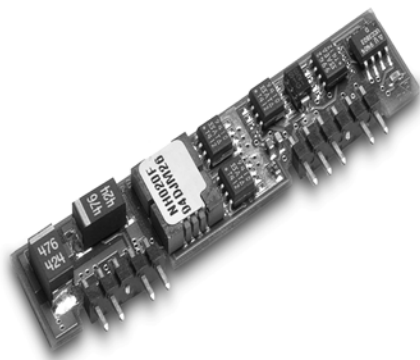

Applications

- Distributed Power Architectures
- Communication Equipment
- Computer Equipment

Options

- Tight Tolerance output
- -40 °C operation

Features

- Compatible with RoHS EU Directive 200295/EC
- Compatible in Pb- free or SnPb reflow environment
- Nonisolated output
- High efficiency: 86% typical
- Small size and low profile:
63.5 mm x 5.6 mm x 14 mm
(2.5 in x 0.22 in x 0.55 in)
- Remote On/Off
- Output overcurrent protection
- Output voltage adjustment
- Overtemperature protection
- UL* 60950 Recognized, CSA† C22.2 No. 60950-00 Certified, and VDE‡ 0805 (IEC60950, 3rd edition) Licensed
- Meets FCC classA radiated limits

Description

The NH020-Series Power SIPs are nonisolated dc-dc converters that operate over an input voltage range of 4.5 Vdc to 5.5 Vdc and provide a precisely regulated dc output. The SIPs have a maximum output current rating of 6 A at a typical full-load efficiency of 86%. Standard features include remote on/off and output voltage adjustment.

* UL is a registered trademark of Underwriters Laboratories, Inc.
† CSA is a registered trademark of Canadian Standards Association.

Absolute Maximum Ratings

Stresses in excess of the absolute maximum ratings can cause permanent damage to the device. These are absolute stress ratings only, functional operation of the device is not implied at these or any other conditions in excess of those given in the operations sections of the data sheet. Exposure to absolute maximum ratings for extended periods can adversely affect the device reliability.

Parameter	Symbol	Min	Max	Unit
Input Voltage: Continuous	V _{IN}	0	7.0	Vdc
Operating Ambient Temperature*	T _{Q31}	-40/0 [†]	115	°C
Storage Temperature	T _{stg}	-55	125	°C
On/Off Terminal Voltage	V _{on/off}	—	6.0	Vdc

* Forced convection—1.5 ms⁻¹ (300 lfm) minimum. Higher ambient temperatures are possible with increased airflow and/or decreased power output. See the Thermal Considerations section for more details.

† The -40 °C operation is optional. See Ordering Information section.

Electrical Specifications

Unless otherwise indicated, specifications apply over all operating input voltage, resistive load, and temperature conditions.

Parameter	Symbol	Min	Typ	Max	Unit
Operating Input Voltage	V _I	4.5	5.0	5.5	Vdc
Maximum Input Current (V _I = 0 to V _{I,max} ; I _O = I _{O,max})	I _{I,max}	—		6.1	A
Inrush Transient	i ² _t	—	—	1	A ² s
Input Reflected-Ripple Current (5 Hz to 20 MHz; 500nH source impedance; See Figure 14)			625		mAp-p
Input Ripple Rejection (100 - 120Hz)			60		dB

CAUTION: This power module is not internally fused. An input line fuse must always be used.

This power SIP can be used in a wide variety of applications, ranging from simple stand-alone operation to an integrated part of a sophisticated power architecture. To preserve maximum flexibility, internal fusing is not included; however, to achieve maximum safety and system protection, always use an input line fuse. The safety agencies require a normal-blow fuse with a maximum rating of 10 A (see Safety Considerations section). To aid in the proper fuse selection for the given application, information on inrush energy and maximum dc input current is provided. Refer to the fuse manufacturer's data for further information.

Electrical Specifications (continued)

Parameter	Device	Symbol	Min	Typ	Max	Unit
Output Voltage Set Point (VI = 5.0 V; IO = IO, max; TA = 25 °C)	NH020M	VO, set	1.46	1.5	1.54	Vdc
	NH020M2	VO, set	1.485	1.5	1.515	Vdc
	NH020Y	VO, set	1.75	1.8	1.85	Vdc
	NH020Y2	VO, set	1.782	1.8	1.818	Vdc
	NH020G	VO, set	2.43	2.5	2.57	Vdc
	NH020F	VO, set	3.18	3.3	3.39	Vdc
Output Voltage (Over all operating input voltage, resistive load, and temperature conditions until end of life.)	NH020M	VO	1.43	—	1.57	Vdc
	NH020M2	VO	1.455	—	1.545	Vdc
	NH020Y	VO	1.716	—	1.883	Vdc
	NH020Y2	VO	1.745	—	1.855	Vdc
	NH020G	VO	2.39	—	2.61	Vdc
	NH020F	VO	3.16	—	3.44	Vdc
Output Regulation: Line (VI = 4.5 V to 5.5 V) Load (IO = 0 to IO, max) Temperature (TA = 0 °C to 55 °C)	All	—	—	0.1	0.4	%VO
	M	—	—	0.4	0.6	%VO
	Y	—	—	0.3	0.5	%VO
	F, G	—	—	0.1	0.3	%VO
	All	—	—	—	17	mV
Output Ripple and Noise Voltage (See Figures 7—9 and 15.): RMS Peak-to-peak (5 Hz to 20 MHz)	F, G, M	—	—	—	25	mVrms
	Y	—	—	—	30	mVrms
	All	—	—	—	100	mVp-p
External Load Capacitance (electrolytic)	All	—	0	—	10,000	μF
Output Current (Forced convection, 1.5 ms ⁻¹ (300 lfm))	All	IO	0	—	6	A
Output Current-limit Inception (VO = 90% of VO, set; see Feature Descriptions section.)	All	IO	—	350	—	%IO, max
Efficiency (VI = 5.0 V; IO = IO, max; TA = 25 °C; see Figures 3—6 and 16.)	NH020M	h	70	72	—	%
	NH020Y	h	73	75	—	%
	NH020G	h	79	82	—	%
	NH020F	h	84	86	—	%
Switching Frequency	All	—	—	500	—	kHz
Dynamic Response (ΔIO/Δt = 1 A/10 μs, VI = 5.0 V, TA = 25 °C; see Figures 10 and 11.): Load Change from IO = 0% to 100% of IO, max: Peak Deviation Settling Time (VO < 10% peak deviation) Load Change from IO = 100% to 0% of IO, max: Peak Deviation Settling Time (VO < 10% peak deviation)	All	—	—	80	—	mV
	All	—	—	200	—	μs
	All	—	—	80	—	mV
	All	—	—	200	—	μs

General Specifications

Parameter	Min	Typ	Max	Unit
Calculated MTBF (IO = 80% of IO, max TA = 25 °C)	1,400,000			Hours
Weight	—	—	7(0.25)	g (oz.)

Feature Specifications

Unless otherwise indicated, specifications apply over all operating input voltage, resistive load, and temperature conditions. See Feature Descriptions for additional information.

Parameter	Device	Symbol	Min	Typ	Max	Unit
Remote On/Off Signal Interface (VI = VI,min to VI, max; open collector pnp or Compatible, Von/off signal referenced to GND. See Figure 20 and Feature Descriptions section)						
Logic Low (ON/OFF pin open—Module On) Ion/off = 0.0 μ A Von/off = 0.3 V	All	Von/off	-0.7		0.3	V
Logic High (VON/OFF > 2.8 V)—Module Off Ion/off = 10 mA Von/off = 5.5 V	All	Ion/off			50	μ A
Turn-on Time (IO = 80% of IO, max; VO within \pm 1% of steady state; see Figure 12)	All	Von/off			6.0	V
	All	Ion/off		1.5	10	mA
	All	—			5.0	ms
Output Voltage Set-point Adjustment Range	NH020M	Vtrim	100	—	150	%VO,
	NH020Y	Vtrim	100	—	120	nom
	NH020G	Vtrim	90	—	110	%VO,
	NH020F	Vtrim	84	—	110	nom
Overtemperature Protection (shutdown)	All	TQ31	—	125	—	$^{\circ}$ C

Characteristic Curves

The following figures provide typical characteristics curves ($T_A = 25^\circ\text{C}$).

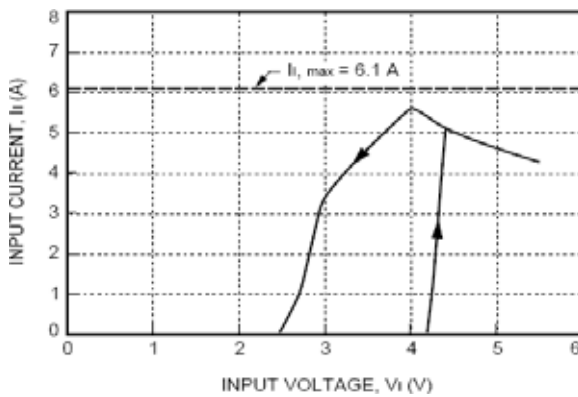

Figure 1. Typical Input Characteristics at 6 A output current.

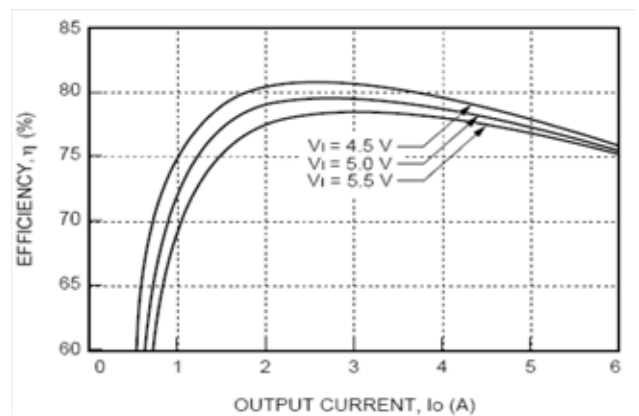

Figure 4. Typical Efficiency for NH020Y.

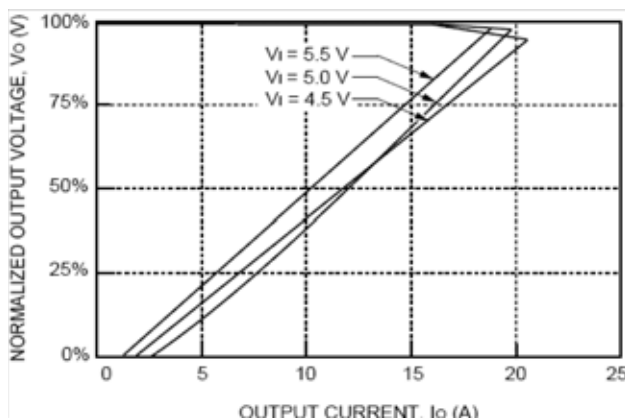

Figure 2. Typical Output Characteristics.

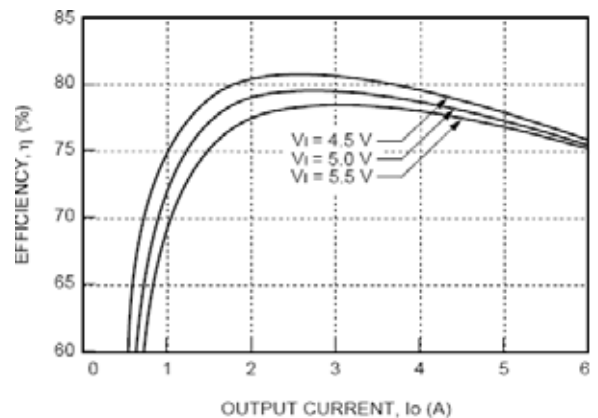

Figure 5. Typical Efficiency for NH020A0G.

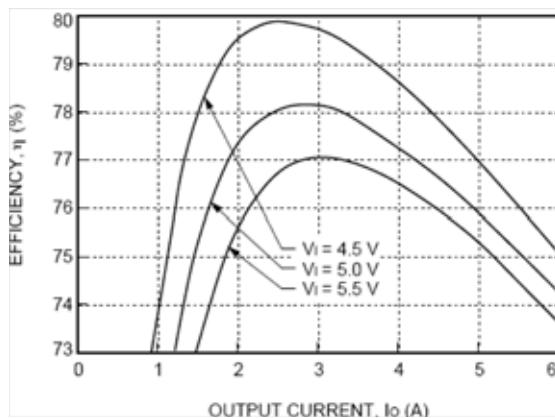

Figure 3. Typical Efficiency for NH020M.

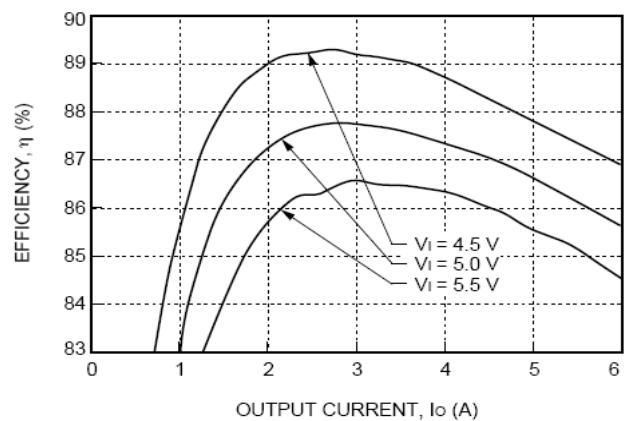

Figure 6. Typical Efficiency for NH020F.

Characteristic Curves

The following figures provide typical characteristics curves at room temperature ($T_A = 25\text{ }^\circ\text{C}$)

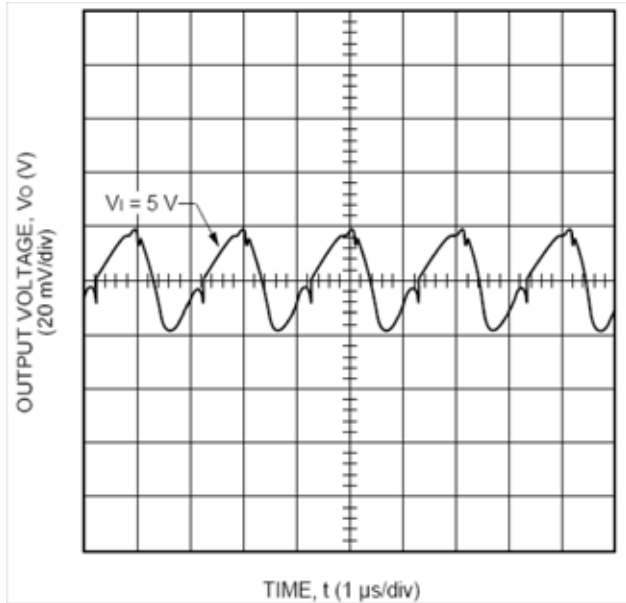

Figure 7. Typical Output Ripple Voltage fo NH020M (6A Output Current).

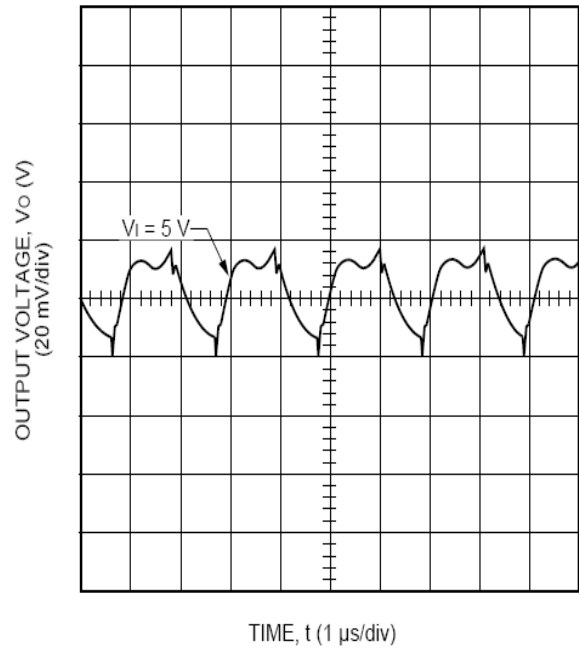

Figure 9. Typical Output Ripple Voltage for NH020F,G (6A Output Current).

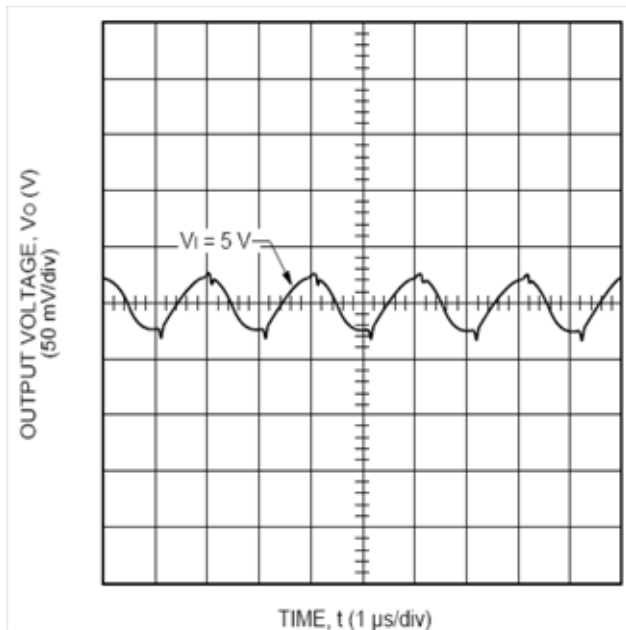

Figure 8. Typical Output Ripple Voltage for NH020Y (6A Output Current).

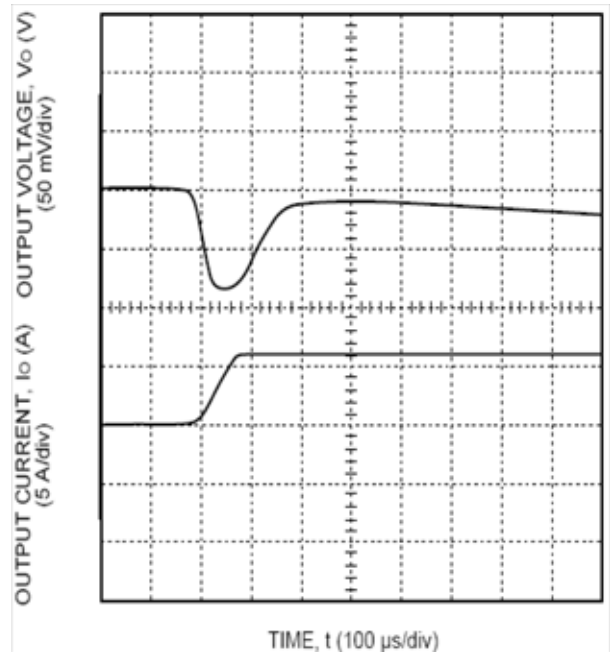

Figure 10. Typical Transient response to Step load change from 0% to 100% of $I_{O,max}$ at 5V Input .

Characteristic Curves

The following figures provide typical characteristics curves at room temperature ($T_A = 25\text{ }^\circ\text{C}$)

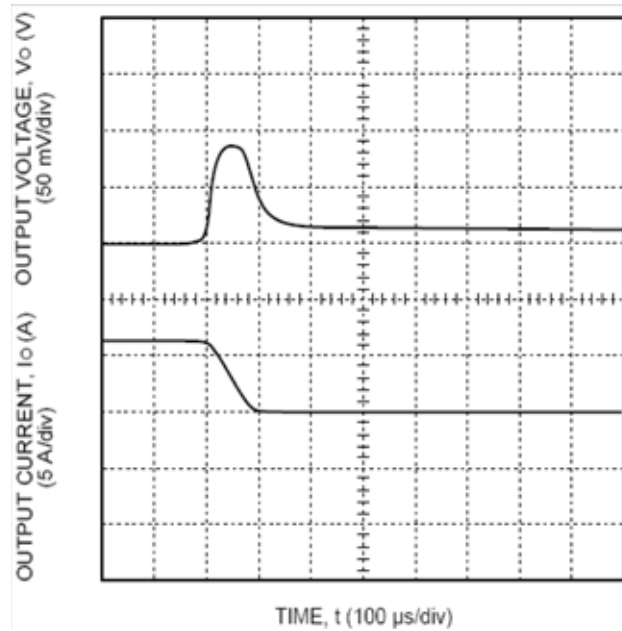

Figure 11. Typical Transient response to Step load change from 100% to 0% of $I_{0,max}$ at 5V Input. (Waveform Averaged to remove ripple)

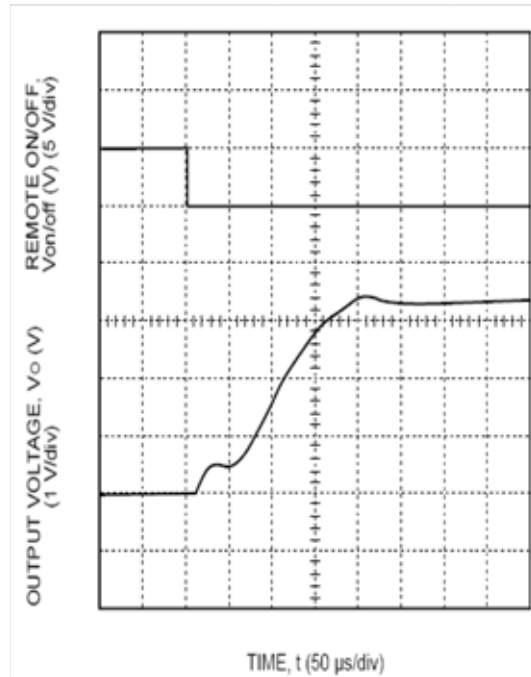

Figure 13. Typical start-up Transient with remote on/off at 5V Input and 6A output.

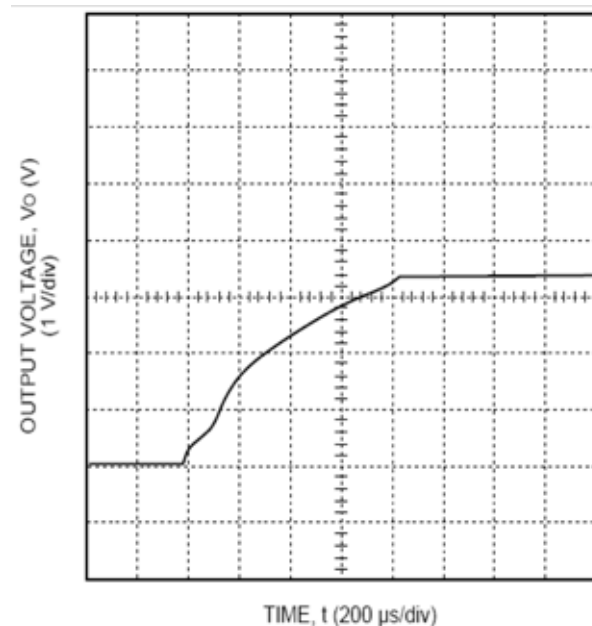
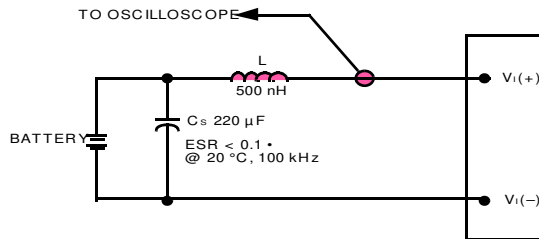

Figure 12. Typical start up Transient at 5V input and 6A output.

Test Configurations



Note: Measure input reflected ripple current with a simulated source inductance (L_{TEST}) of 500nH. Capacitor C_S offsets possible battery impedance. Measure current as shown above.

Figure 14. Input Reflected Ripple Current Test Setup.

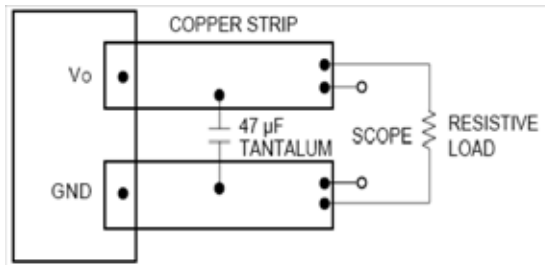

Note: Scope measurements should be made using a BNC socket, with a 47 µF tantalum capacitor. Position the load between 51 mm and 76 mm (2 in and 3 in) from the module

Figure 15. Peak-to-Peak Output Ripple Measurement Test Setup.

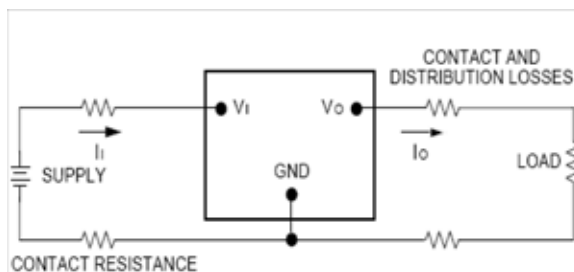

Note: All voltage measurements to be taken at the module terminals, as shown above. If sockets are used then Kelvin connections are required at the module terminals to avoid measurement errors due to socket contact resistance.

Figure 16. Output Voltage and Efficiency Test Setup.

$$\eta = \left(\frac{[V_{O(+)} - V_{O(-)}] \times I_O}{[V_{I(+)} - V_{I(-)}] \times I_I} \right) \times 100$$

Design Considerations

Input Source Impedance

The power SIP should be connected to a low ac-impedance input source. Highly inductive source impedances can affect the stability of the SIP. Adding external capacitance close to the input pins of the SIP can reduce the ac impedance and ensure system stability. The minimum recommended input capacitance (C_1) is a 100 µF electrolytic capacitor (see Figures 17 and 19).

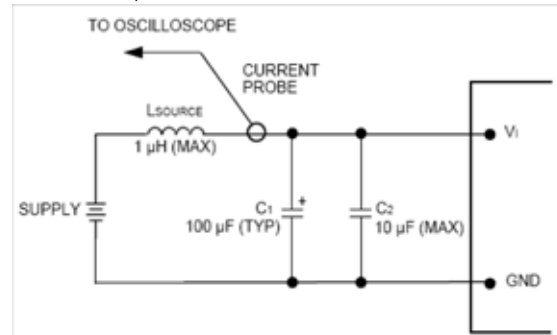

Figure 17. Setup with External Capacitor to Reduce Input Ripple Voltage .

To reduce the amount of ripple current fed back to the input supply (input reflected-ripple current), an external input filter can be added. Up to 10 µF of ceramic capacitance (C_2) may be externally connected to the input of the SIP, provided the source inductance (L_{SOURCE}) is less than 1 µH (see Figure 17).

To further reduce the input reflected-ripple current, a filter inductor (L_{FILTER}) can be connected between the supply and the external input capacitors (see Figure 18).

As mentioned above, a 100 µF electrolytic capacitor (C_1) should be added across the input of the SIP to ensure stability of the unit. The electrolytic capacitor should be selected for ESR and RMS current ratings to ensure safe operation in the case of a fault condition. Refer to Figure 19 for the appropriate electrolytic capacitor ratings.

When using a tantalum input capacitor, take care not to exceed device power rating because of the capacitor's failure mechanism (for example, a short circuit). The filter inductor should be rated to handle the maximum power SIP input current of 6.1 Adc.

If the amount of input reflected-ripple current is unacceptable with an external L-C filter, more capacitance may be added across the input supply to form a C-L-C filter. For best results, the filter components should be mounted close to the power SIP.

Design Considerations (continued)

Input Source Impedance (continued)

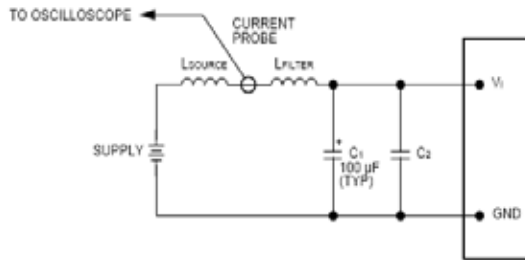

Figure 18. Setup with External Input Filter to Reduce Input Reflected-Ripple Current and Ensure Stability.

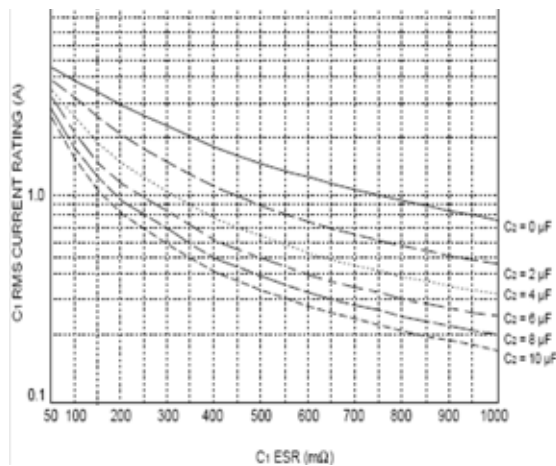

Figure 19. Electrolytic Capacitor ESR and RMS Current Rating Data.

Safety Considerations

For safety-agency approval of the system in which the power module is used, the power module must be installed in compliance with the spacing and separation requirements of the end-use safety agency standard, i.e., *UL60950*, *CSA C22.2 No. 60950-00*, and *VDE 0805:2001-12 (IEC60950, 3rd Ed)*.

For the converter output to be considered meeting the requirements of safety extra-low voltage (SELV), the input must meet SELV requirements.

The power module has ELV (extra-low voltage) outputs when all inputs are ELV.

The input to these units is to be provided with a maximum 10A normal-blow fuse in the unearthed lead.

If an input electrolytic capacitor is to be used, it should be selected using the design information found in the Design Considerations section.

Feature Descriptions

Remote On/Off

To turn the power SIP on and off, the user must supply a switch to control the voltage at the on/off terminal (Von/off). The switch can be an open collector pnp transistor connected between the on/off terminal and the VI terminal or its equivalent (see Figure 20).

During a logic low when the ON/OFF pin is open, the power SIP is on and the maximum Von/off generated by the power SIP is 0.3 V. The maximum allowable leakage current of the switch when Von/off = 0.3 V and VI = 5.5 V (Vswitch = 5.2 V) is 50 μ A.

During a logic high, when Von/off = 2.8 V to 5.5 V, the power SIP is off and the maximum Ion/off is 10 mA. The switch should maintain a logic high while sourcing 10 mA.

If not using the remote on/off feature, leave the ON/OFF pin open.

The SIP has internal capacitance to reduce noise at the ON/OFF pin. Additional capacitance is not generally needed and may degrade the start-up characteristics of the SIP.

CAUTION: Never ground the on/off terminal. Grounding the on/off terminal disables an important safety feature and may damage the SIP or the customer system.

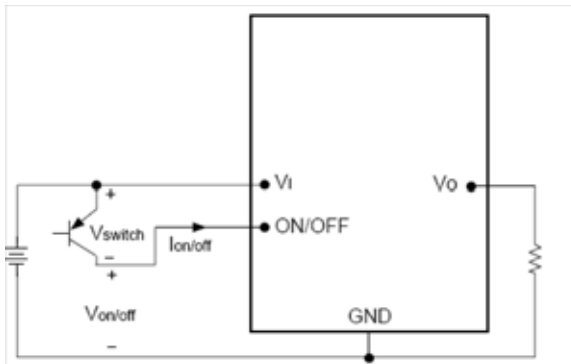

Figure 20. Remote On/Off Implementation.

Output Voltage Set-Point Adjustment (Trim)

Output voltage set-point adjustment allows the output voltage set point to be increased or decreased by connecting an external resistor between the TRIM pin and either the VO pin (decrease output voltage) or GND pin (increase output voltage). The trim range for the NH020F is +10%, -16%. The trim range for the NH020G is \pm 10% of VO, nom. The trim range for SIPs that produce less than 2.5 VO is +20%, -0%.

Connecting an external resistor (Rtrim-down) between the TRIM and VO pin decreases the output voltage set point as defined in the following equation.

For the F (3.3 VO) SIP:

$$R_{\text{trim-down}} = \left(\frac{18.23}{V_O - V_{O, \text{adj}}} - 15 \right) \text{k}\Omega$$

For the G (2.5 VO) SIP:

$$R_{\text{trim-down}} = \left(\frac{6.975}{2.498 - V_{O, \text{adj}}} - 15 \right) \text{k}\Omega$$

Note: Output voltages below 2.5 V cannot be trimmed down.

The test results for these configurations are displayed in Figures 21 and 22.

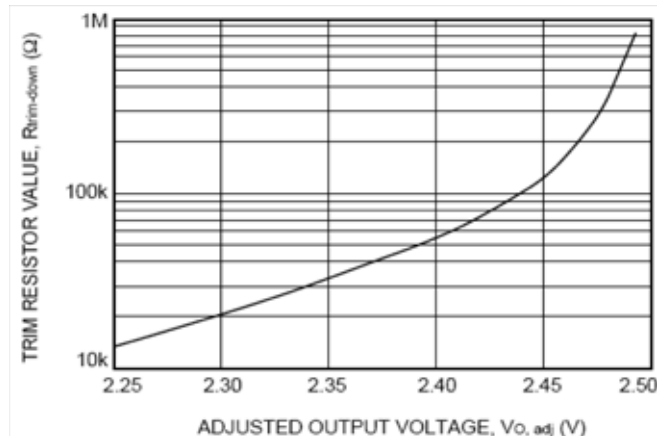

Figure 21. NH020G Rtrim-down Test Results .

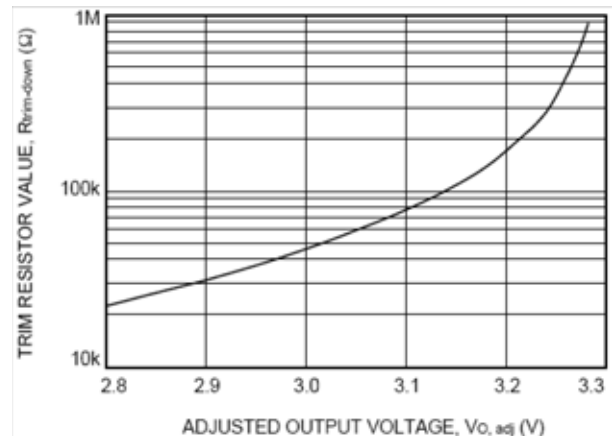

Figure 22. NH020F Rtrim-down Test Results .

Connecting an external resistor (Rtrim-up) between the TRIM and GND pins increases the output voltage set point to VO, adj as defined in the following equation:

$$R_{\text{trim-up}} = \left(\frac{28}{V_{O, \text{adj}} - V_O} - 1 \right) \text{k}\Omega$$

The test results for this configuration are displayed in Figures 23—26.

Leave the TRIM pin open if not using that feature.

Feature Descriptions (continued)

Output Voltage Set-Point Adjustment
(Trim) (continued)

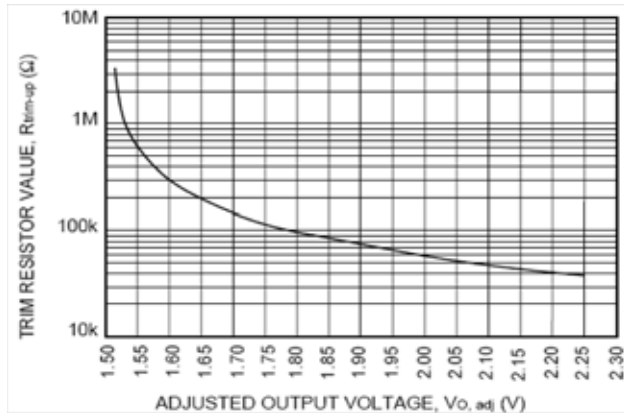

Figure 23. NH020M Rtrim-up Test Results.

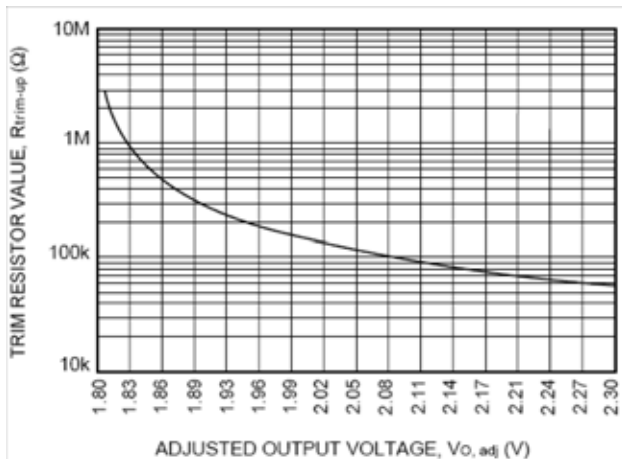

Figure 24. NH020Y Rtrim-up Test Results.

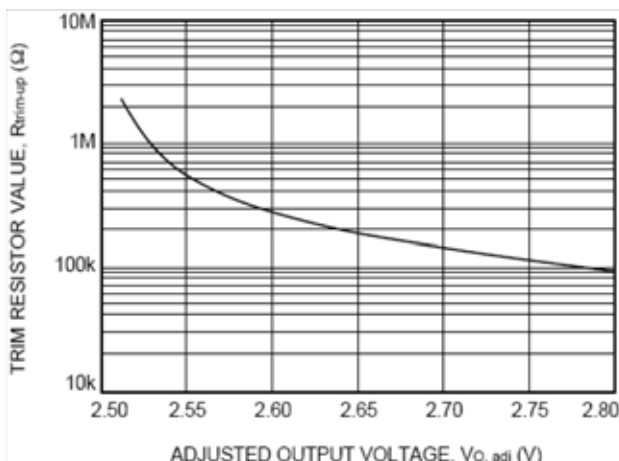

Figure 25. NH020G Rtrim-up Test Results .

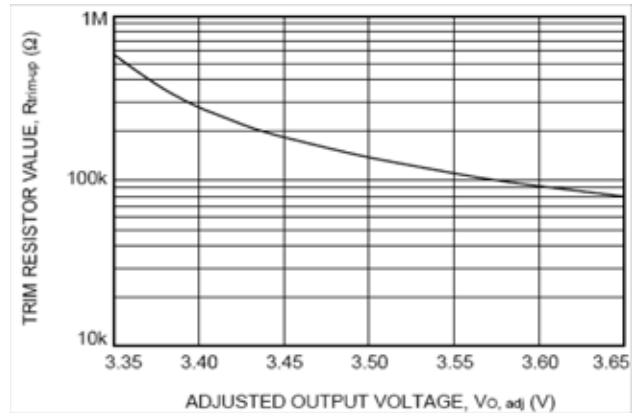

Figure 26. NH020F Rtrim-up Test Results .

Overcurrent Protection

To provide protection in a fault condition, the unit is equipped with internal overcurrent protection. The unit operates normally once the fault condition is removed.

The power module will supply up to 350% of rated current for less than 1.25 seconds before it enters thermal shutdown.

Overtemperature Protection

To provide additional protection in a fault condition, the unit is equipped with a nonlatched thermal shutdown circuit. The shutdown circuit engages when Q1 or Q2 exceeds approximately 110 °C. The unit attempts to restart when Q1 or Q2 cool down and cycles on and off while the fault condition exists. Recovery from shutdown is accomplished when the cause of the overtemperature condition is removed.

Thermal Considerations

To predict the approximate cooling needed for the SIP, determine the power dissipated as heat by the unit for the particular application. Figures 29—32 show typical heat dissipation for the SIP over a range of output currents.

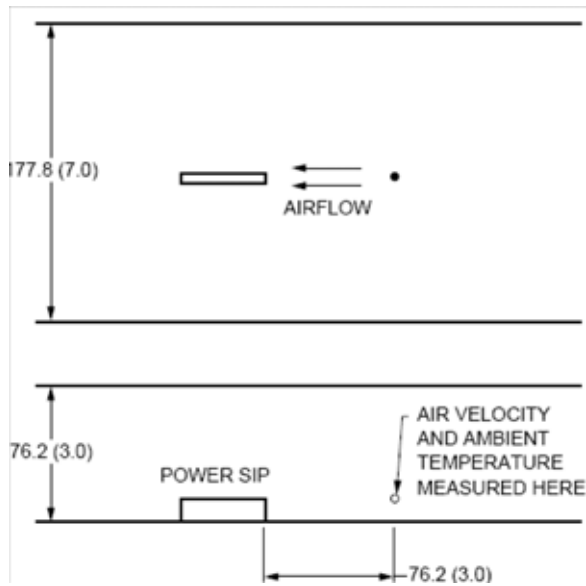

Note: Dimensions are in millimeters and (inches).

Figure 27. Thermal Test Setup.

Proper cooling can be verified by measuring the power SIP's temperature at lead 7 of Q31 as shown in Figure 28.

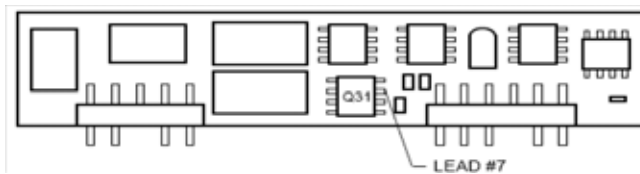

Figure 28. Temperature Measurement Location.

The temperature at this location should not exceed 115 °C. The output power of the SIP should not exceed the rated power for the SIP as listed in the Ordering Information table.

Convection Requirements for Cooling

To predict the approximate cooling needed for the SIP, determine the power dissipated as heat by the unit for the particular application. Figures 29—32 show typical heat dissipation for the SIP over a range of output currents.

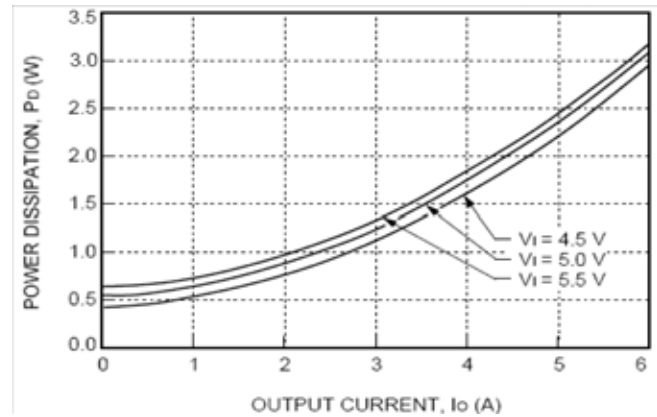

Figure 29. NH020M Power Dissipation vs. Output current.

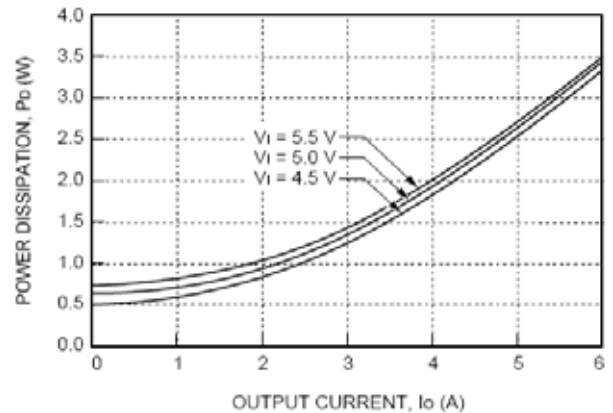

Figure 30. NH020Y Power Dissipation vs. Output Current.

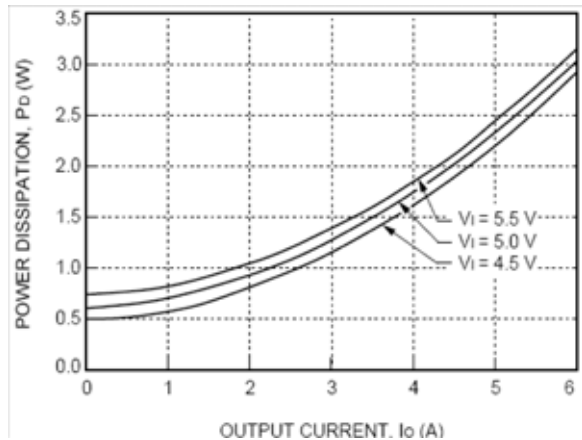

Figure 31. NH020G Power Dissipation vs. Output Current.

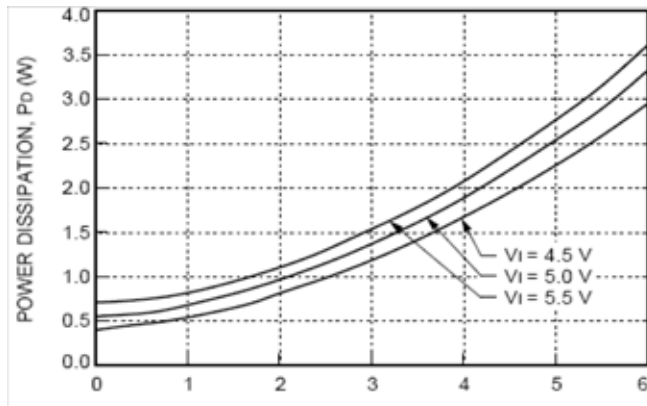

Figure 32. NH020F Power Dissipation vs. Output Current.

With the known heat dissipation and a given local ambient temperature, the minimum airflow can be chosen from the derating curves in Figure 33.

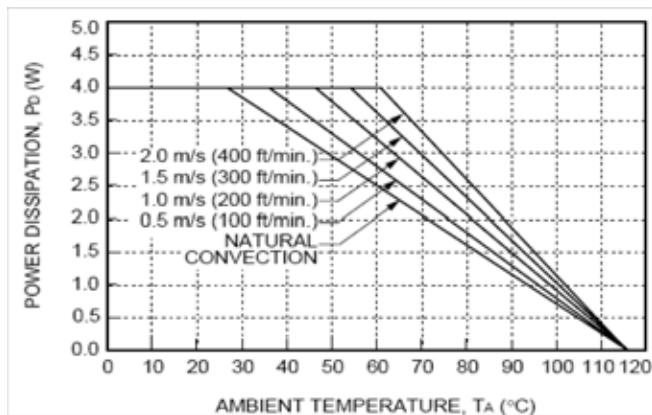

Figure 33. Power Derating vs. Local Ambient Temperature and Air Velocity.

For example, if the unit dissipates 2.0 W of heat, the minimum airflow in an 80 °C environment is 1.0 m/s (200 ft./min.).

Keep in mind that these derating curves are approximations of the ambient temperatures and airflows required to keep the power SIP temperature below its maximum rating. Once the SIP is assembled in the actual system, the SIP's temperature should be checked as shown in Figure 28 to ensure it does not exceed 115 °C.

Layout Considerations

Copper paths must not be routed between pins 2 and 3 and pins 7 and 8.

Through-Hole Lead-Free Soldering Information

The RoHS-compliant through-hole products use the SAC (Sn/Ag/Cu) Pb-free solder and RoHS-compliant components. They are designed to be processed through single or dual wave soldering machines. The pins have an RoHS-compliant finish that is compatible with both Pb and Pb-free wave soldering processes. A maximum preheat rate of 3°C/s is suggested. The wave preheat process should be such that the temperature of the power module board is kept below 210°C. For Pb solder, the recommended pot temperature is 260°C, while the Pb-free solder pot is 270°C max. Not all RoHS-compliant through-hole products can be processed with paste-through-hole Pb or Pb-free reflow process. If additional information is needed, please consult with your Tyco Electronics Power System representative for more details.

Post Solder Cleaning and Drying Considerations

Post solder cleaning is usually the final circuit-board assembly process prior to electrical board testing. The result of inadequate cleaning and drying can affect both the reliability of a power module and the testability of the finished circuit-board assembly. For guidance on appropriate soldering, cleaning and drying procedures, refer to Tyco Electronics *Board Mounted Power Modules: Soldering and Cleaning* Application Note (AP01-056EPS).

Solder Ball and Cleanliness Requirements

The open frame (no case or potting) power module will meet the solder ball requirements per J-STD-001B. These requirements state that solder balls must neither be loose nor violate the power module minimum electrical spacing. The cleanliness designator of the open frame power module is C00 (per J specification).

Outline Diagram for Through-Hole Module

Dimensions are in millimeters and (inches).

Tolerances: x.x mm ± 0.5 mm (x.xx in. ± 0.02 in.) [unless otherwise indicated]
 x.xx mm ± 0.25 mm (x.xxx in. ± 0.010 in.)

Front View

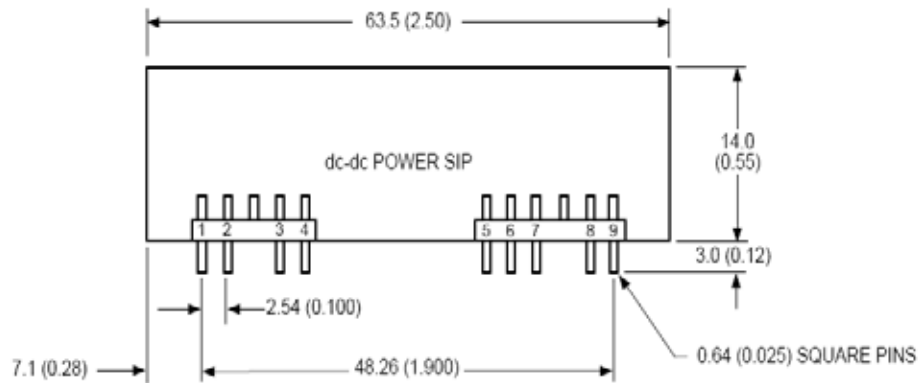

Side View

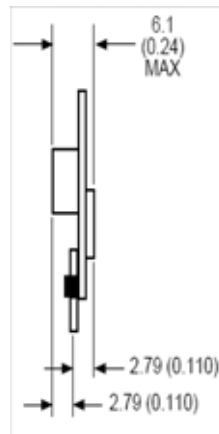

Pin	Function
1	VO
2	VO
3	VO
4	GND
5	GND
6	VI
7	VI
8	TRIM
9	ON/OFF

Recommended Hole Pattern

Component-side footprint.

Dimensions are in millimeters and (inches).

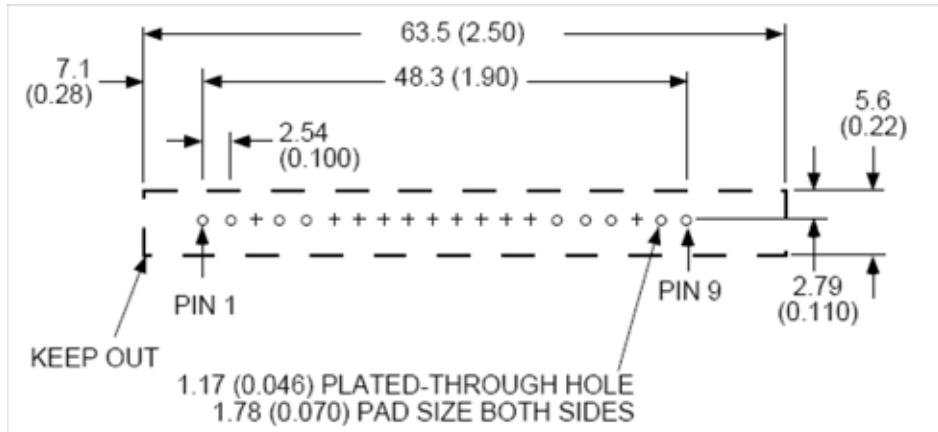

Note: No copper should be placed between pins 2 and 3 and pins 7 and 8.

Ordering Information

Please contact your Tyco Electronics' Sales Representative for pricing, availability and optional features.

Table 1. Device Codes

Input Voltage	Output Voltage	Output Current	Device Code	Comcodes
5 V	1.5 V	9 W	NH020M	107870065
5 V	1.8 V	10.8 W	NH020Y	TBD
5 V	2.5 V	15 W	NH020G	107917114
5 V	3.3 V	20 W	NH020F	107221145
5V	3.3V	20W	NH020FZ	CC109114121
5 V	2.5 V	15 W	NH020GZ	CC109102753
5 V	1.8 V	10.8 W	NH020Y2Z	CC109102761

Optional features can be ordered using the suffixes shown below. The suffixes follow the last letter of the Product Code and are placed in descending alphanumerical order.

Table 2. Device Options

Option	Suffix
Tight tolerance output (not available on the NH020G)	2
-40 °C operation	5
RoHS Compliant	-Z



World Wide Headquarters
Lineage Power Corporation
3000 Skyline Drive, Mesquite, TX 75149, USA
+1-800-526-7819
(Outside U.S.A.: **+1-972-284-2626**)
www.lineagepower.com
e-mail: techsupport1@lineagepower.com

Asia-Pacific Headquarters
Tel: +65 6 41 6 4283

Europe, Middle-East and Africa Headquarters
Tel: +49 89 6089 286

India Headquarters
Tel: +91 80 28411633

Lineage Power reserves the right to make changes to the product(s) or information contained herein without notice. No liability is assumed as a result of their use or application. No rights under any patent accompany the sale of any such product(s) or information.

© 2008 Lineage Power Corporation, (Mesquite, Texas) All International Rights Reserved.