



Chipsmall Limited consists of a professional team with an average of over 10 year of expertise in the distribution of electronic components. Based in Hongkong, we have already established firm and mutual-benefit business relationships with customers from,Europe,America and south Asia,supplying obsolete and hard-to-find components to meet their specific needs.

With the principle of "Quality Parts,Customers Priority,Honest Operation,and Considerate Service",our business mainly focus on the distribution of electronic components. Line cards we deal with include Microchip,ALPS,ROHM,Xilinx,Pulse,ON,Everlight and Freescale. Main products comprise IC,Modules,Potentiometer,IC Socket,Relay,Connector.Our parts cover such applications as commercial,industrial, and automotives areas.

We are looking forward to setting up business relationship with you and hope to provide you with the best service and solution. Let us make a better world for our industry!



Contact us

Tel: +86-755-8981 8866 Fax: +86-755-8427 6832

Email & Skype: info@chipsmall.com Web: www.chipsmall.com

Address: A1208, Overseas Decoration Building, #122 Zhenhua RD., Futian, Shenzhen, China



5-INPUT 3-OUTPUT VIDEO SWITCH

■ GENERAL DESCRIPTION

The **NJM2595** is a 5-input 3-output video switch. Its switches select one from five signals received from VTR, TV, DVD, TV-GAME and others.

The NJM2595 is designed for audio items, such as AV amplifier and others.

■ PACKAGE OUTLINE

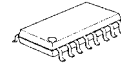

NJM2595M

■ FEATURES

- 5-input 3-output
- Operating Voltage ± 4.0 to $\pm 6.5V$
- Operating current $\pm 15mA$ typ. at $V_{CC}=\pm 5V$
- Crosstalk $-65dB$ typ.
- Internal 6dB Amplifier
- Internal 75Ω Driver
- Bipolar Technology
- Package Outline DMP16

■ PIN CONFIGURATION and BLOCK DIAGRAM

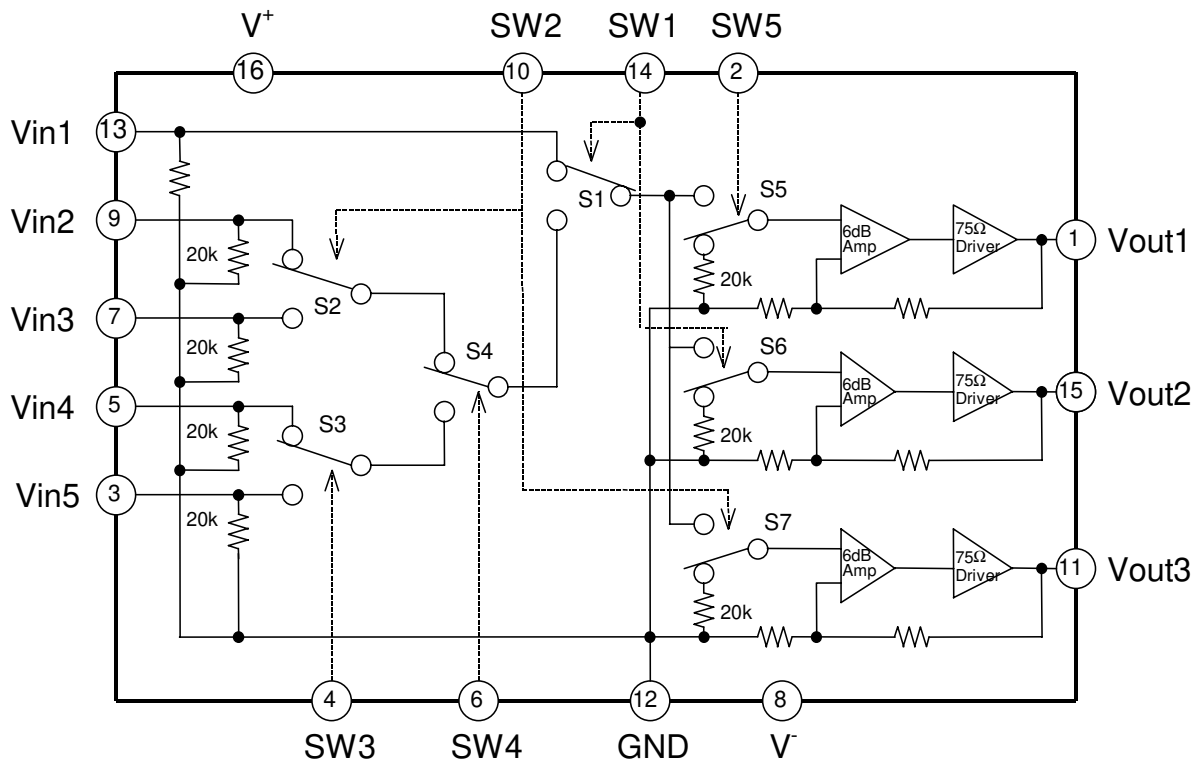

NJM2595

■ ABSOLUTE MAXIMUM RATINGS

(Ta=25°C)

PARAMETER	SYMBOL	RATINGS	UNIT
Supply Voltage	V ^{+/-}	±7.0	V
Power Dissipation	P _D	350	mW
Operating Temperature Range	T _{opr}	-40 to +85	°C
Storage Temperature Range	T _{stg}	-40 to +125	°C

■ ELECTRICAL CHARACTERISTICS (V⁺/V⁻=±5V, R_L=150Ω, Ta=25°C)

PARAMETER	SYMBOL	TEST CONDITION	MIN.	TYP.	MAX.	UNIT
Positive Operating Current	I _{cc}	No signal	-	15	22	mA
Negative Operating Current	I _{ee}	No signal	-22	-15	-	mA
Voltage Gain	G _v	V _{in} =1.0V _{pp} , f=100kHz	6.0	6.3	6.8	dB
Frequency Characteristic	G _f	V _{in} =1.0V _{pp} , f=5MHz/100kHz	-1.0	0.0	+1.0	dB
Differential Gain	DG	V _{in} =1.0V _{pp} , Typical stair-case signal	-	0.2	-	%
Differential Phase	DP	V _{in} =1.0V _{pp} , Typical stair-case signal	-	0.2	-	deg
Output Offset Voltage 1	V _{os1}	No signal, between Vin2 and Vin3	-40	0.0	+40	mV
Output Offset Voltage 2	V _{os2}	No signal, between Vin1 and Vin2, between Vin1 and Vin3	-60	0.0	+60	
Between Input Crosstalk	CT	V _{in} =1.0V _{pp} , f=4.43MHz, V _o /V _{in}	-	-65	-	dB
Crosstalk at Mute	CT _m	V _{in} =1.0V _{pp} , f=4.43MHz, V _o /V _{in}	-	-55	-	dB
Total Harmonic Distortion	THD	V _{in} =1.25V _{pp} , f=1kHz	-	0.1	-	%
Switch Select Voltage at High	V _{ch}		2.0	-	V ⁺	V
Switch Select Voltage at Low	V _{cl}		0	-	0.8	
Input Impedance	R _{in}		-	20	-	KΩ

■ Control Signal vs. Output Signal (L=V_{CL}, H=V_{CH}, X=L or H)

SW1	SW2	SW3	SW4	SW5	V _{out1}	V _{out2}	V _{out3}
L	H	X	X	H	V _{in1}	MUTE	V _{in1}
	L			V _{in1}	MUTE	MUTE	
	H			MUTE	MUTE	V _{in1}	
H	L	X	L	H	V _{in2}	V _{in2}	MUTE
				L	MUTE	V _{in2}	MUTE
H	H	X	L	H	V _{in3}	V _{in3}	V _{in3}
				L	MUTE	V _{in3}	V _{in3}
H	H	L	H	H	V _{in4}	V _{in4}	V _{in4}
	H			L	MUTE	V _{in4}	V _{in4}
	L			H	V _{in4}	V _{in4}	MUTE
	L			L	MUTE	V _{in4}	MUTE
H	H	H	H	H	V _{in5}	V _{in5}	V _{in5}
	H			L	MUTE	V _{in5}	V _{in5}
	L			H	V _{in5}	V _{in5}	MUTE
	L			L	MUTE	V _{in5}	MUTE
L	L	X	X	L	MUTE	MUTE	MUTE

■ EQUIVALENT CIRCUIT

PIN No.	PIN NAME	INSIDE EQUIVALENT CIRCUIT	VOLTAGE
16	V ⁺		5V
8	V ⁻		-5V
12	GND		-
13 9 7 5 3	Vin1 Vin2 Vin3 Vin4 Vin5		0V
1 15 11	Vout1 Vout2 Vout3		0V
4 6 2	SW3 SW4 SW5		-

NJM2595

■ EQUIVALENT CIRCUIT

PIN No.	PIN NAME	INSIDE EQUIVALENT CIRCUIT	VOLTAGE
14 10	SW1 SW2		-

■ TEST CIRCUIT

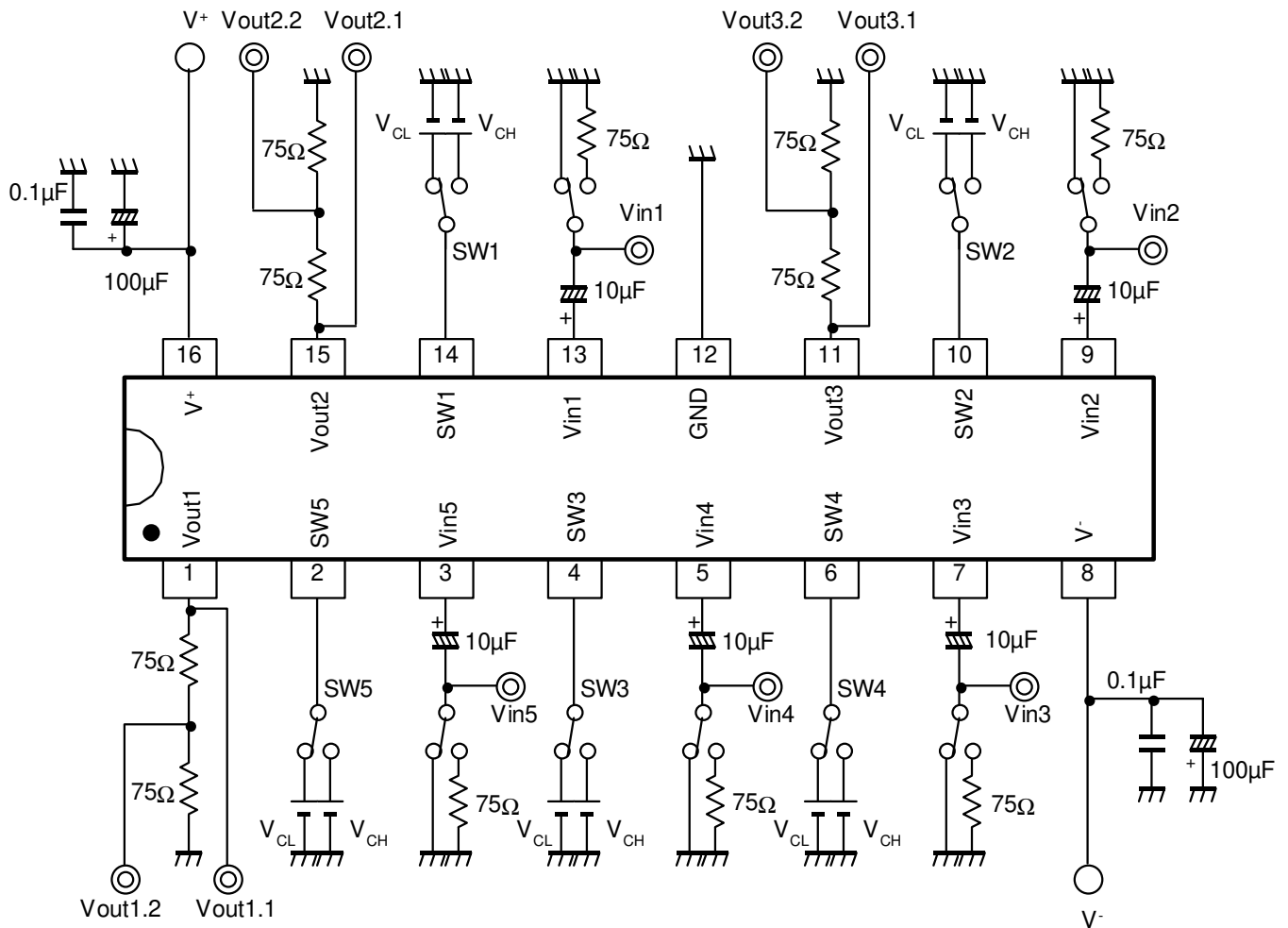

APPLICATION CIRCUIT

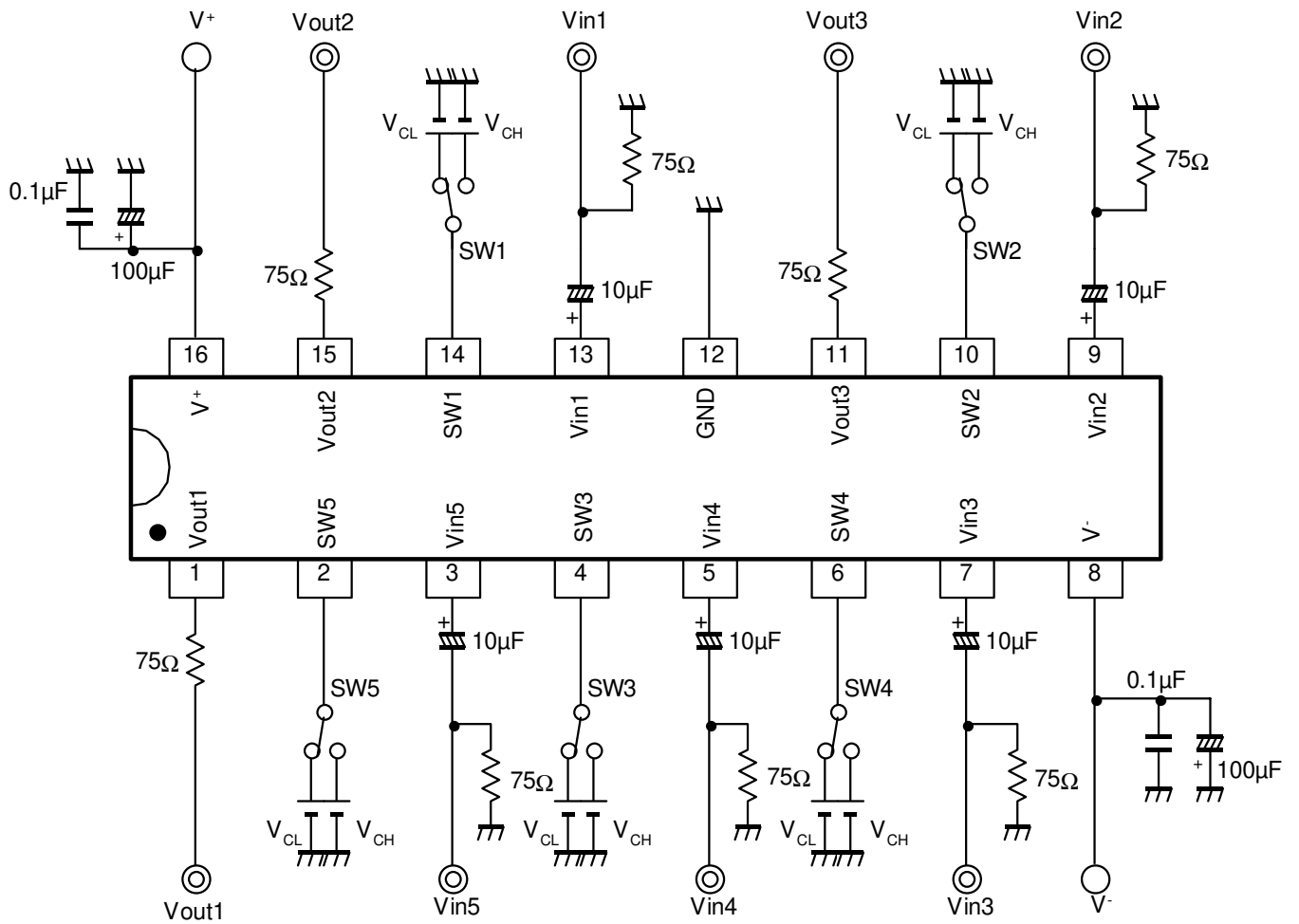

■ TYPICAL CHARACTERISTICS

Voltage Gain vs. Frequency

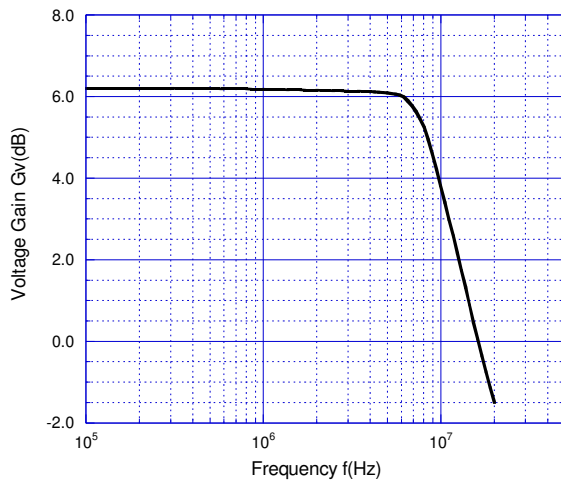

Maximum Output Voltage Swing vs. Supply Voltage

Total Harmonic Distortion=1%, 100kHz

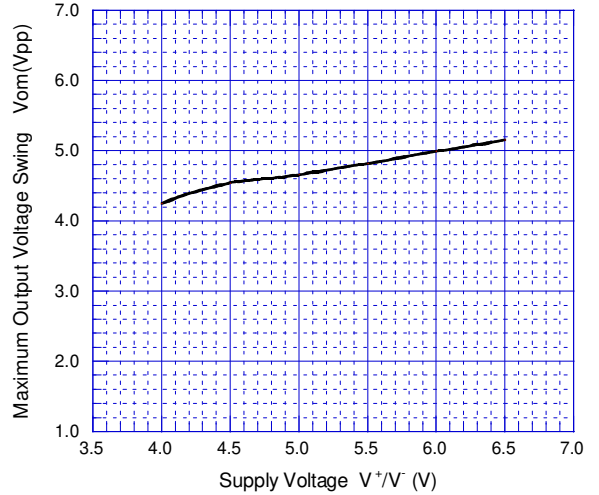

Operating Current vs. Supply Voltage

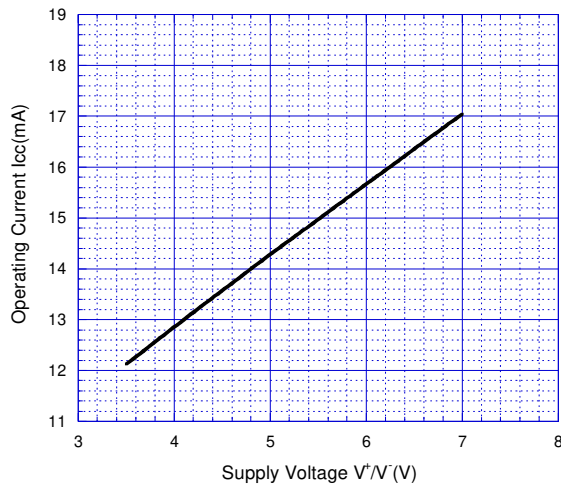

Operating Current vs. Supply Voltage

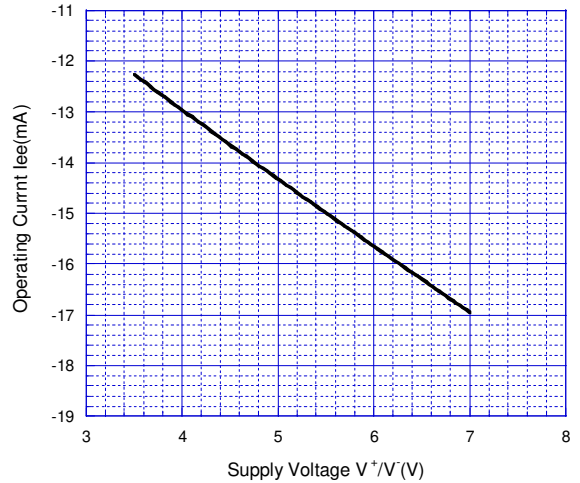

Voltage Gain vs. Supply Voltage

1Vpp, 100kHz SinWave

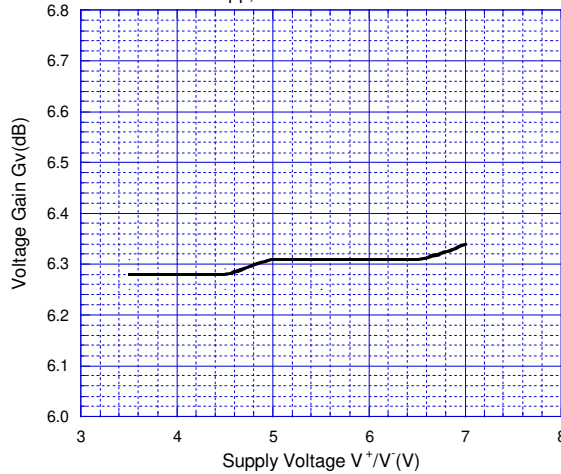

Gain Frequency Characteristic vs. Supply Voltage

1Vpp, 5MHz/100kHz SinWave

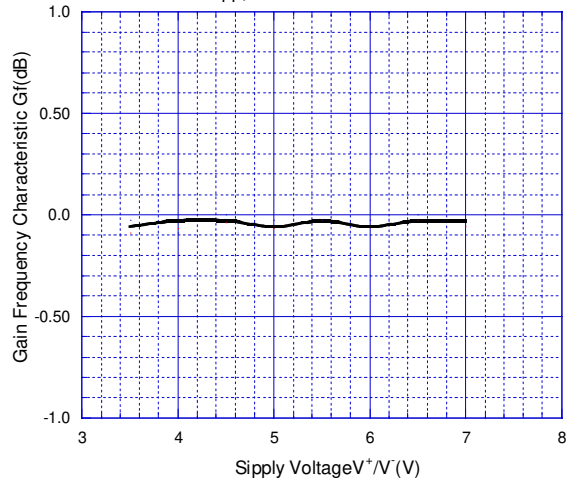

■ TYPICAL CHARACTERISTICS

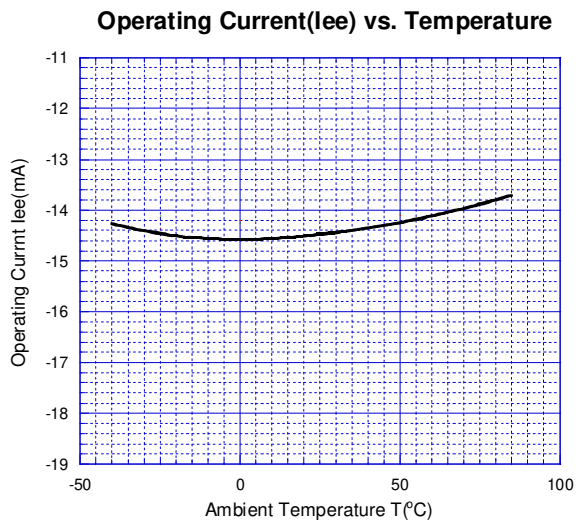
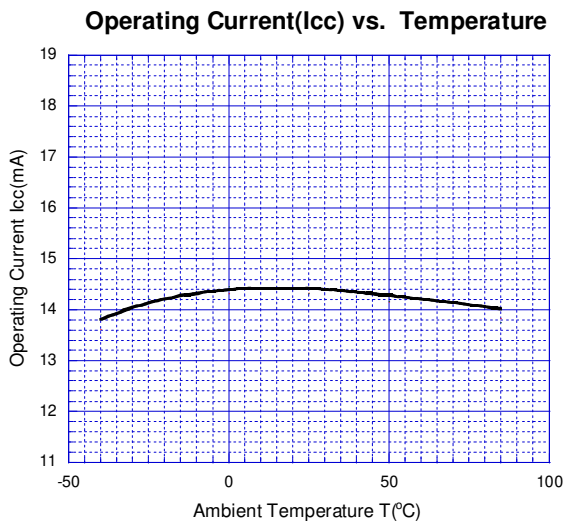
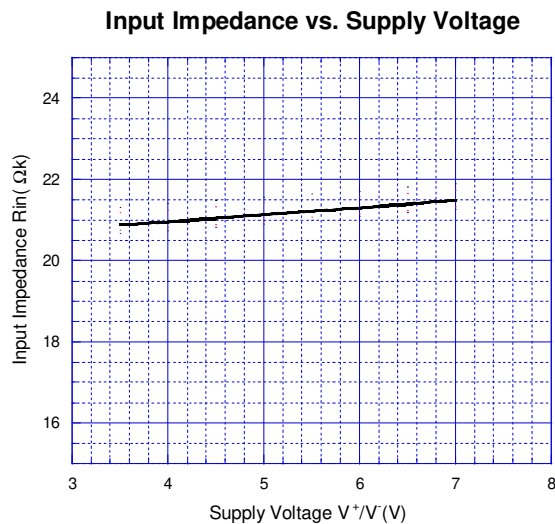
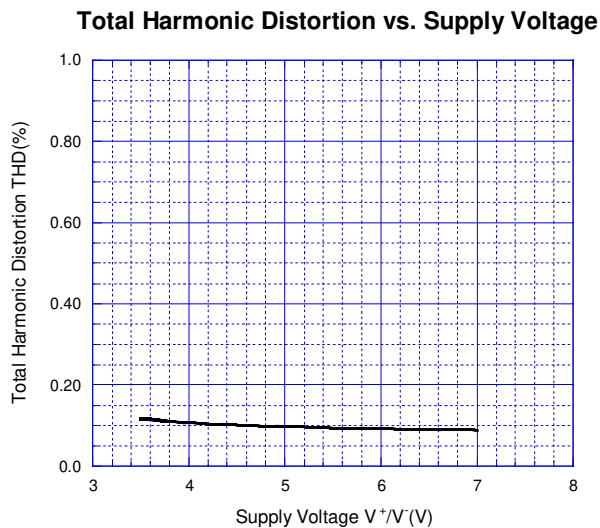
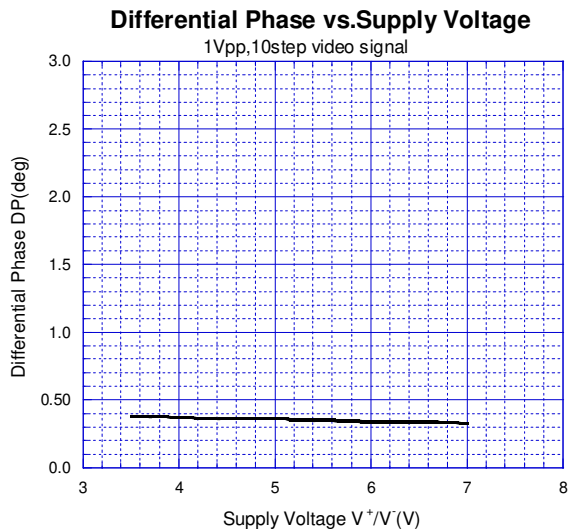
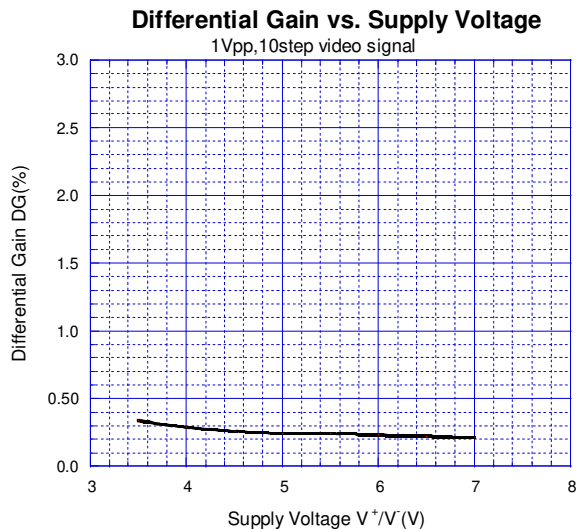

■ TYPICAL CHARACTERISTICS

Voltage Gain vs. Temperature

1Vpp, 100kHz SinWave

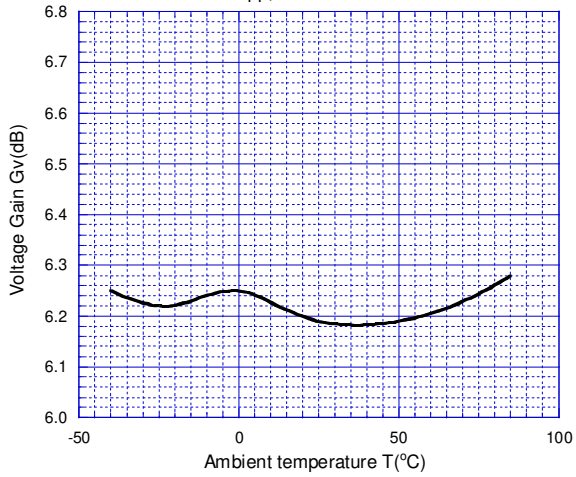

Gain Frequency Characteristic vs. Temperature

1Vpp, 5MHz/100kHz SinWave

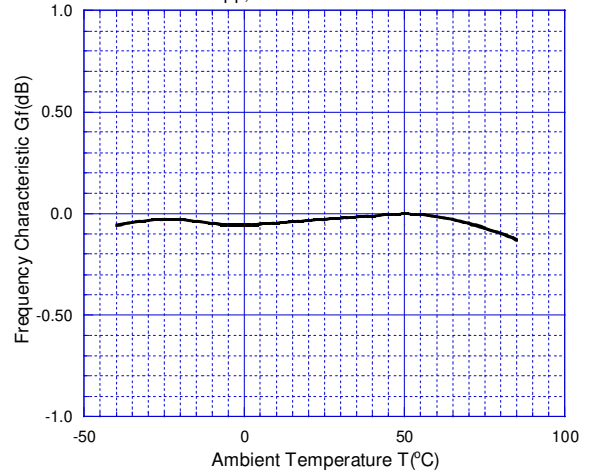

Differential Gain vs. Temperature

1Vpp, 10step video signal

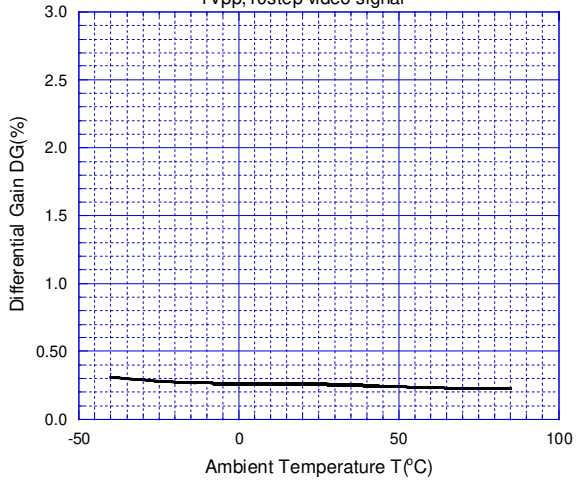

Differential Phase vs. Temperature

1Vpp, 10step video signal

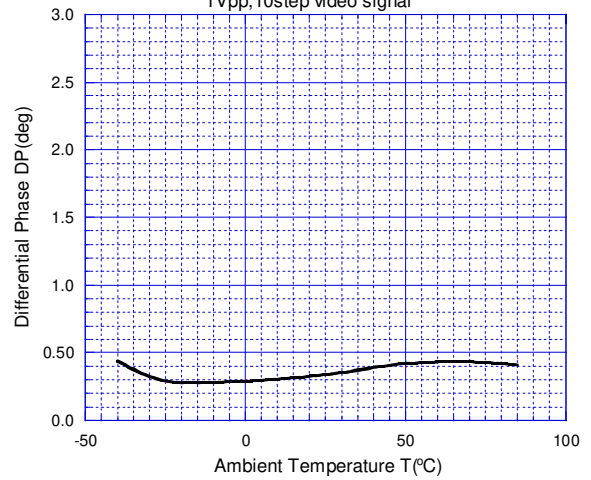

Total Harmonic Distortion vs. Temperature

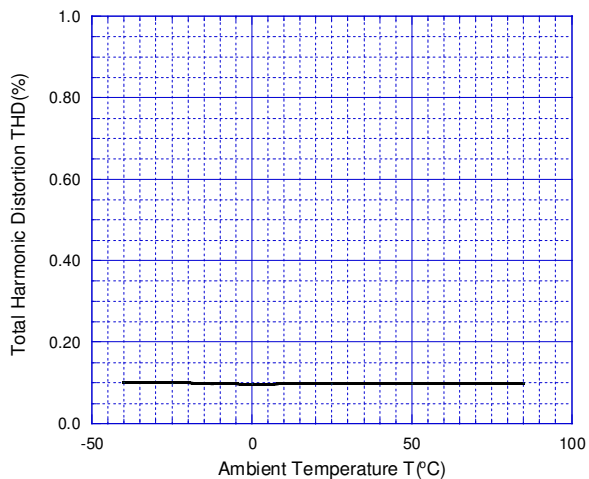

Input Impedance vs. Temperature

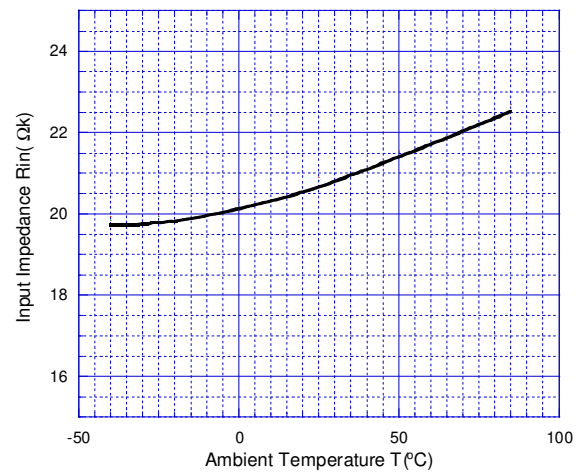

[CAUTION]

The specifications on this databook are only given for information, without any guarantee as regards either mistakes or omissions. The application circuits in this databook are described only to show representative usages of the product and not intended for the guarantee or permission of any right including the industrial rights.