



Chipsmall Limited consists of a professional team with an average of over 10 year of expertise in the distribution of electronic components. Based in Hongkong, we have already established firm and mutual-benefit business relationships with customers from,Europe,America and south Asia,supplying obsolete and hard-to-find components to meet their specific needs.

With the principle of “Quality Parts,Customers Priority,Honest Operation,and Considerate Service”,our business mainly focus on the distribution of electronic components. Line cards we deal with include Microchip,ALPS,ROHM,Xilinx,Pulse,ON,Everlight and Freescale. Main products comprise IC,Modules,Potentiometer,IC Socket,Relay,Connector.Our parts cover such applications as commercial,industrial, and automotives areas.

We are looking forward to setting up business relationship with you and hope to provide you with the best service and solution. Let us make a better world for our industry!



Contact us

Tel: +86-755-8981 8866 Fax: +86-755-8427 6832

Email & Skype: info@chipsmall.com Web: www.chipsmall.com

Address: A1208, Overseas Decoration Building, #122 Zhenhua RD., Futian, Shenzhen, China



Rail-to-Rail Input/Output Single Operational Amplifier

■ GENERAL DESCRIPTION

NJM2730 is a Rail-to-Rail Input/Output single operational amplifier featuring Low power, low noise and operation from 1.8V.

Rail-to-Rail Input/Output provides wide dynamic range, is from ground to power supply level. In addition to ground sensing applications, NJM2730 enable to be applied to Hi-side sensing applications.

The features are low noise and high phase margin for battery management, portable audio applications, and others.

Furthermore NJM2730 is packaged with small size package SOT-23-5

■ PACKAGE OUTLINE



NJM2730F

■ FEATURES

- Single Supply 1.8 to 5.0V
- Operating Voltage $V_{ICM} = 0$ to 5.0V at $V^+ = 5V$
- Rail-to-Rail Input $V_{OH} \geq 4.9V / V_{OL} \leq 0.1V$ at $V^+ = 5V, R_L = 20k\Omega$
- Rail-to-Rail Output $V_{OH} \geq 4.75V / V_{OL} \leq 0.25V$ at $V^+ = 5V, R_L = 2k\Omega$
- Load Drivability 5mV max
- Offset Voltage 0.4V/ μ s typ.
- Slew Rate 10nV/ \sqrt{Hz} typ.
- Low Input Voltage Noise $\Phi_M = 75deg.$ typ. at $R_L = 2k\Omega$, voltage follower
- Adequate phase margin
- Bipolar Technology
- Package Outline SOT-23-5

■ PIN CONFIGURATION

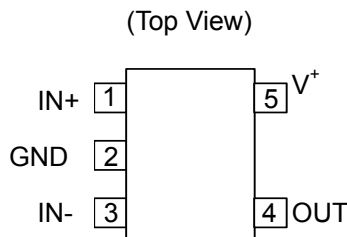

NJM2730

■ ABSOLUTE MAXIMUM RATINGS

(Ta=25°C)

PARAMETER	SYMBOL	RATINGS	UNIT
Supply Voltage	V ⁺	7.0	V
Differential Input Voltage	V _{ID}	±1.0	V
Input Common Mode Voltage Range	V _{ICM}	0 to 7.0	V
Power Dissipation	P _D	200	mW
Operating Temperature Range	T _{opr}	-40 to +85	°C
Storage Temperature Range	T _{stg}	-40 to +125	°C

(Note1)

If the supply voltage (V⁺) is less than 7V, the input voltage must not over the V⁺ level through 7V is limit specified.

■ RECOMMENDED OPERATING CONDITION

(Ta=25°C)

PARAMETER	SYMBOL	RATING	UNIT
Supply Voltage	V ⁺	1.8 to 5.0	V

■ ELECTRICAL CHARACTERISTICS

● DC CHARACTERISTICS

(V⁺=5V, Ta=25°C)

PARAMETER	SYMBOL	TEST CONDITION	MIN	TYP	MAX	UNIT
Operating Current	I _{CC}	No Signal	-	320	550	μA
Input Offset Voltage	V _{IO}		-	1	5	mV
Input Bias Current	I _B		-	50	250	nA
Input Offset Current	I _{IO}		-	5	100	nA
Voltage Gain	A _V	R _L =2kΩ	60	85	-	dB
Common Mode Rejection Ratio	CMR	CMR+: 2.5V ≤ V _{CM} ≤ 5.0V, CMR-: 0 ≤ V _{CM} ≤ 2.5V (Note2)	55	70	-	dB
Supply Voltage Rejection Ratio	SVR		70	85	-	dB
Maximum Output Voltage 1	V _{OH1}	R _L =20kΩ	4.9	4.95	-	V
	V _{OL1}	R _L =20kΩ	-	0.05	0.1	
Maximum Output Voltage 2	V _{OH2}	R _L =2kΩ	4.75	4.85	-	V
	V _{OL2}	R _L =2kΩ	-	0.15	0.25	
Input Common Mode Voltage Range	V _{ICM}	CMR > 55dB	0	-	5	V

(Note2) CMR is represented by either CMR+ or CMR- which has lower value.

CMR+ is measured with 2.5V ≤ V_{CM} ≤ 5V and CMR- is measured with 0V ≤ V_{CM} ≤ 2.5V.

● AC CHARACTERISTICS

(V⁺=5V, Ta=25°C)

PARAMETER	SYMBOL	TEST CONDITION	MIN	TYP	MAX	UNIT
Unity Gain Bandwidth	f _T	R _L =2kΩ	-	1	-	MHz
Phase Margin	Φ _M	R _L =2kΩ	-	75	-	Deg
Equivalent Input Noise Voltage	V _N	f=1kHz	-	10	-	nV/ √Hz

● TRANSIENT CHARACTERISTICS

(V⁺=5V, Ta=25°C)

PARAMETER	SYMBOL	TEST CONDITION	MIN	TYP	MAX	UNIT
Slew Rate	SR	R _L =2kΩ	-	0.4	-	V/μs

■ TERMINAL CHARACTERISTICS

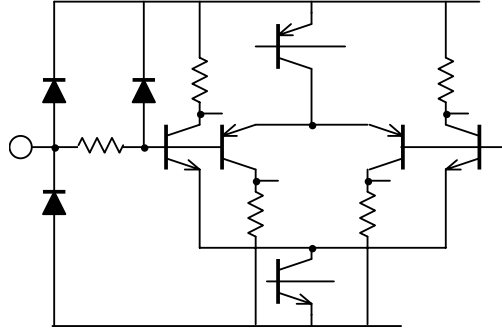
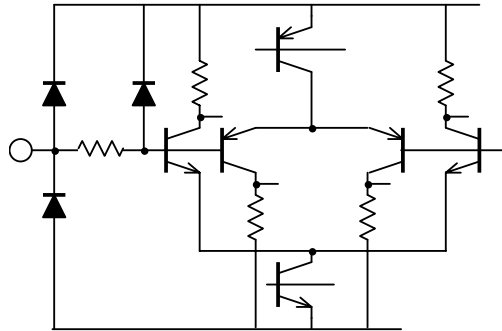
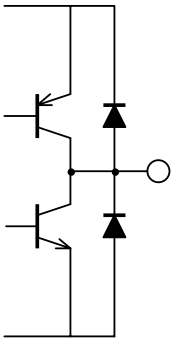
No.	Symbol	Equivalent Circuit	Typ.DC Voltage(V)	Function
1	+INPUT			non-inverting input
3	-INPUT			inverting input
4	VOUT			output

■ TYPICAL CHARACTERISTICS

(Note: R_s, R_g, R_L and C_L are connected to $V^+/2$ when single supply.)

Operating Current vs. Operating Voltage

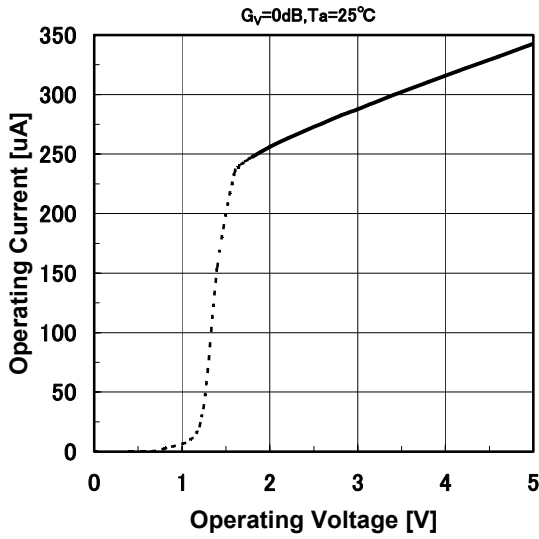

Operating Current vs. Operating Voltage

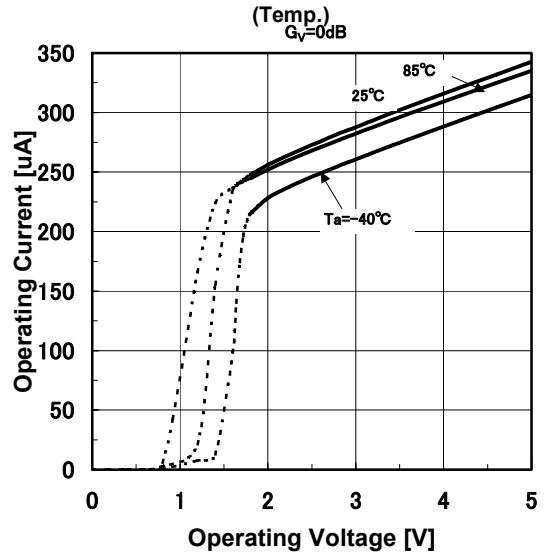

Operating Current vs. Temperature

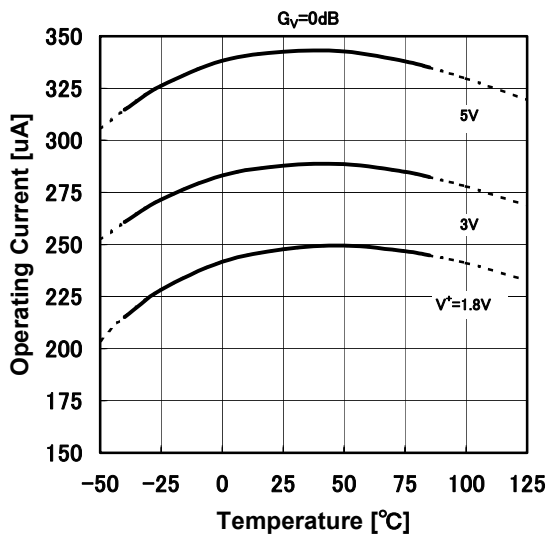

Input Offset Voltage vs. Temperature

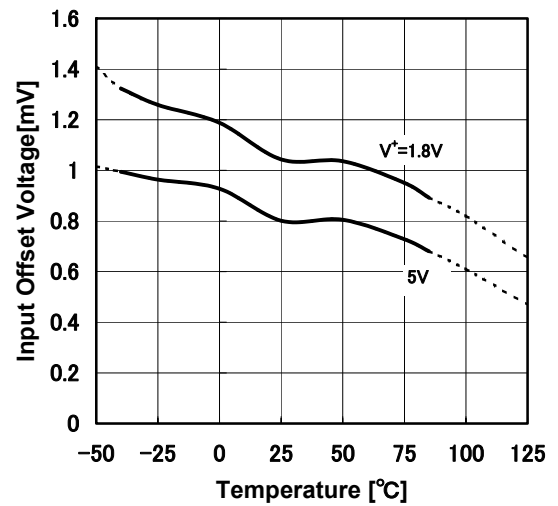

Input Bias Current vs. Temperature

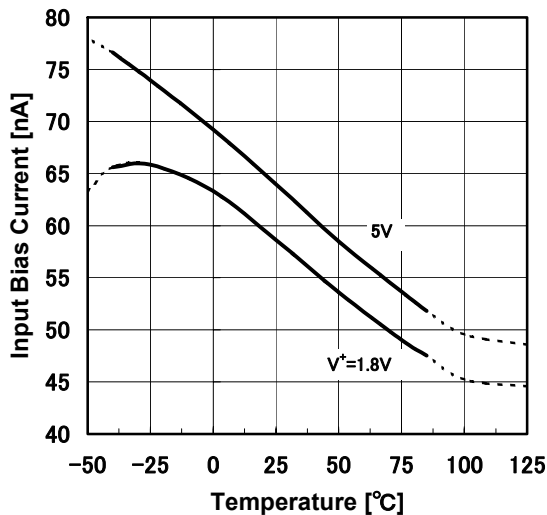

Input Offset Current vs. Temperature

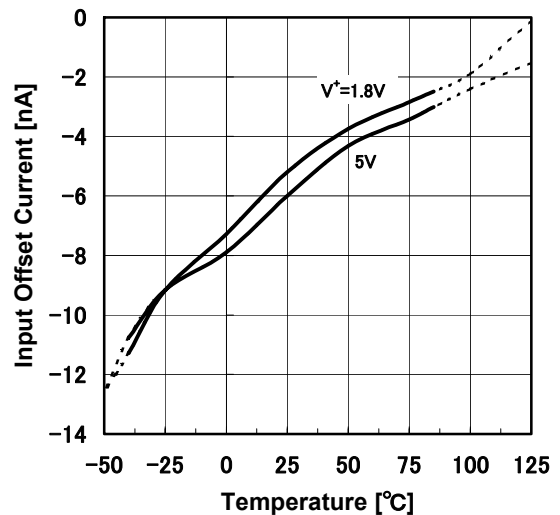

Output Voltage vs. Operating Voltage
 $G_V=OPEN, R_L=2k, T_a=25^\circ C$

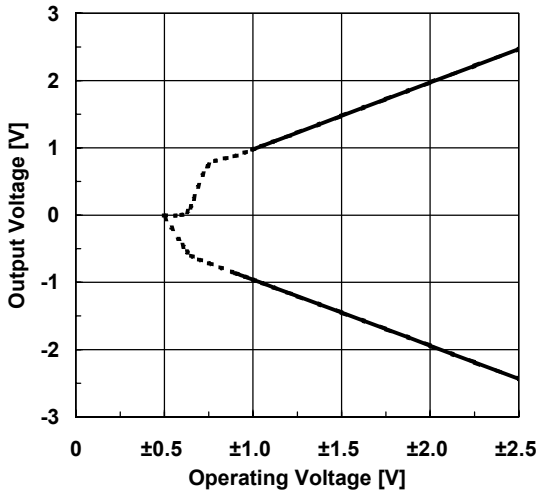

Output Voltage vs. Load Resistance (V^+/V^-)
 $G_V=OPEN, T_a=25^\circ C$

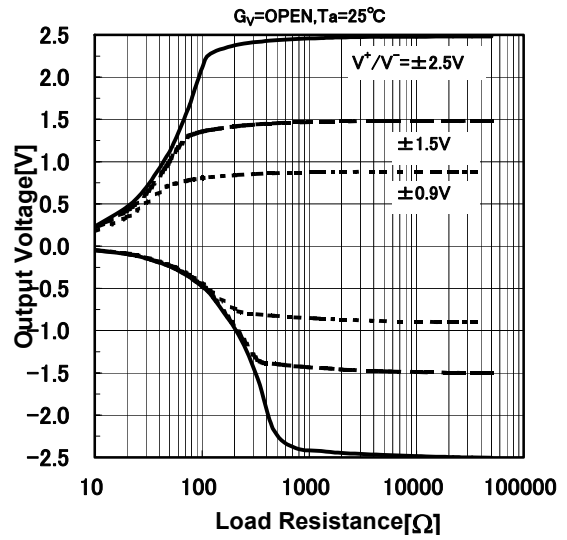

Output Voltage vs. Load Resistance(Temp.)
 $V^+=5V, G_V=OPEN$

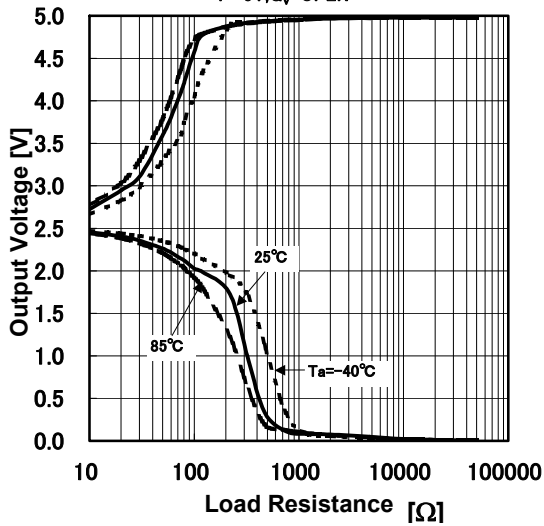

Voltage Gain, Phase vs. Frequency (Temp.)
 $V^+=5V, G_V=40dB, R_i=2k, R_o=20, C_L=0$

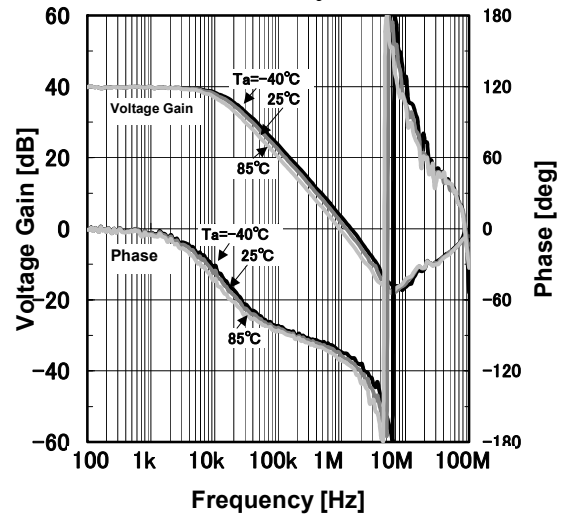

Equivalent Input Noise Voltage vs. Frequency

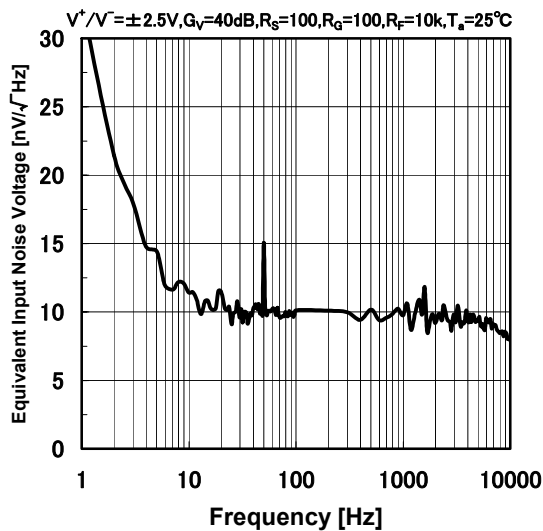

Equivalent Input Noise Voltage vs. Input Resistance

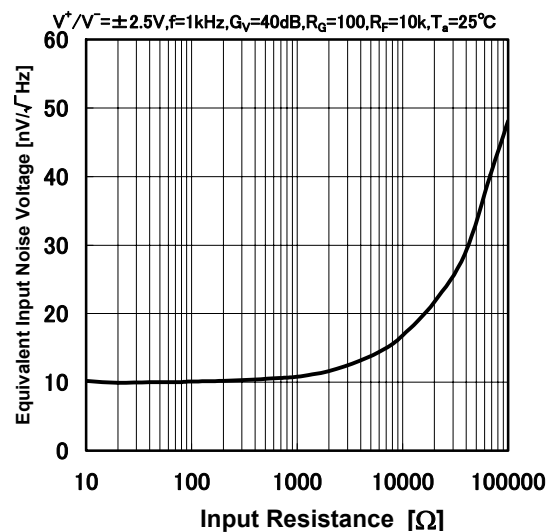

V.F.Peak vs.Frequency (Load C.)

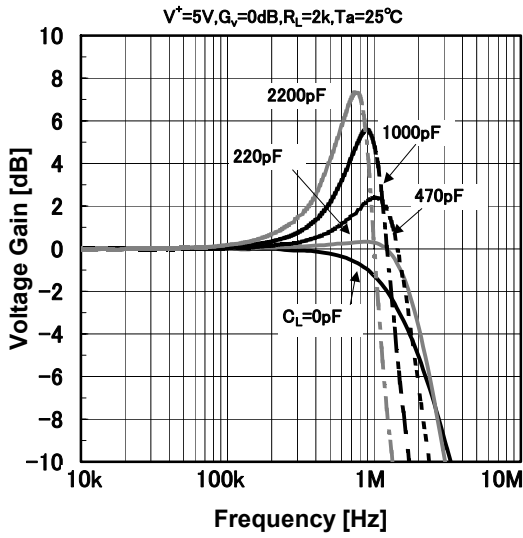

V.F.Peak vs.Frequency (Temp.)

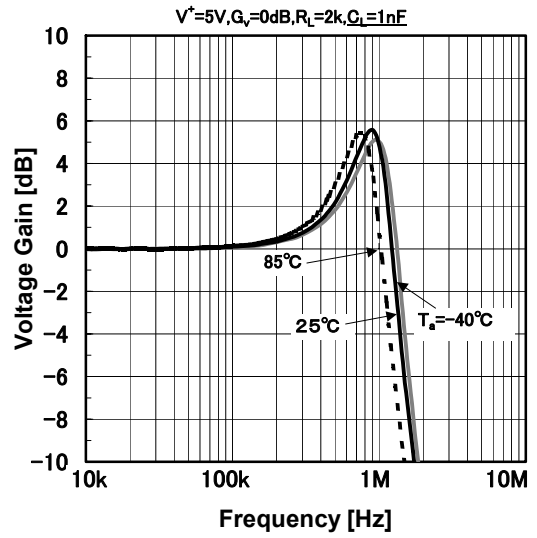

Common Mode Rejection Ratio vs. Temperature

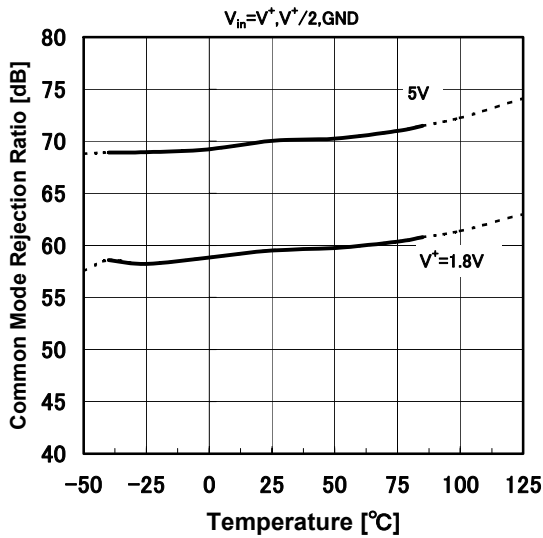

Supply Voltage Rejection Ratio vs. Temperature

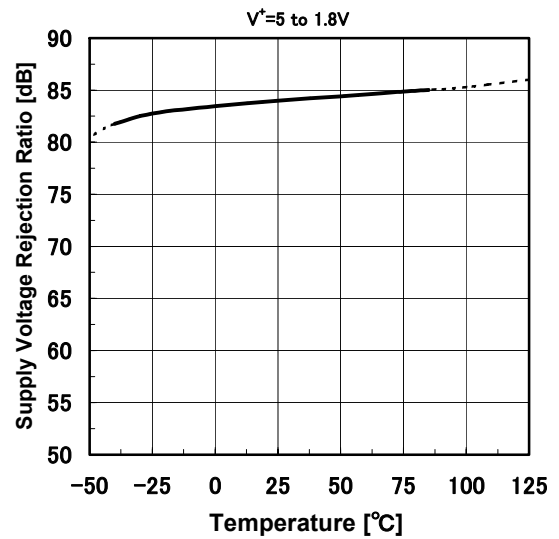

Overshoot vs. Load Capacitance

$V^+=5V, V_{in}=1V_{p-p}, f=10kHz, G_v=0dB$
 $R_s=50, R_l=2k, T_a=25^\circ C$

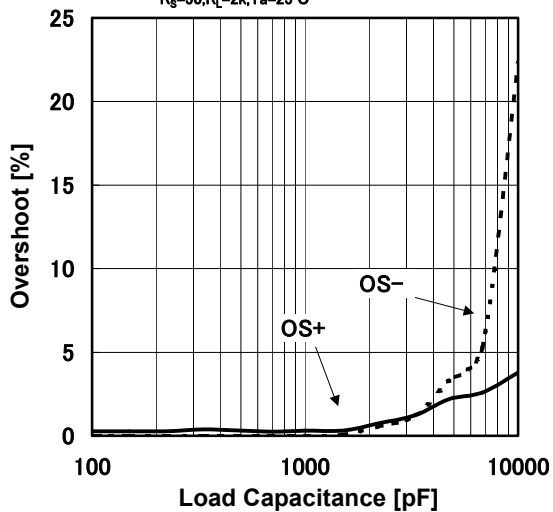

Phase Margin vs. Load Capacitance

$V^+=5V, G_v=40dB, V_{in}=-30dBm,$
 $R_s=50, R_e=20, R_l=2k, T_a=25^\circ C$

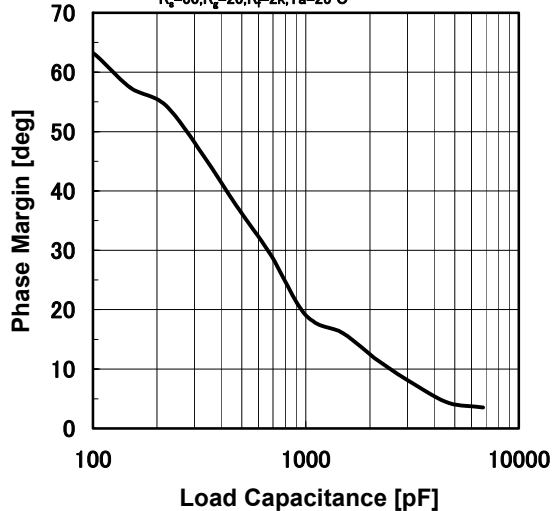

Gain Bandwidth Product vs. Load Capacitance

$V^+=5V, G_v=40dB, V_{in}=-30dBm,$
 $R_s=50, R_e=20, R_l=2k, T_a=25^\circ C$

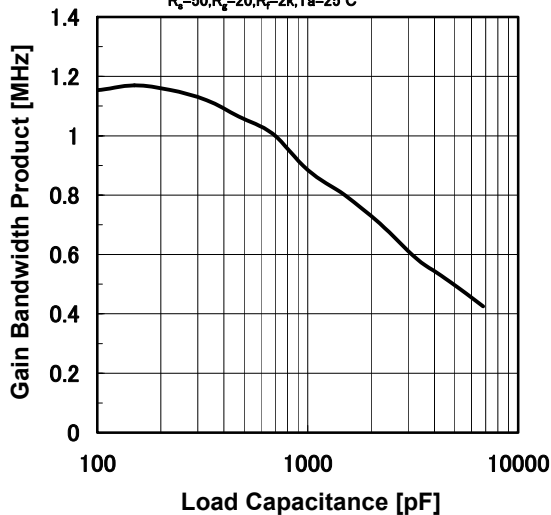

Pulse Response

$V^+=5V, V_{in}=1V_{p-p}, f=10kHz, G_v=0dB$
 $R_s=50, R_l=2k, C_l=0F, T_a=25^\circ C$

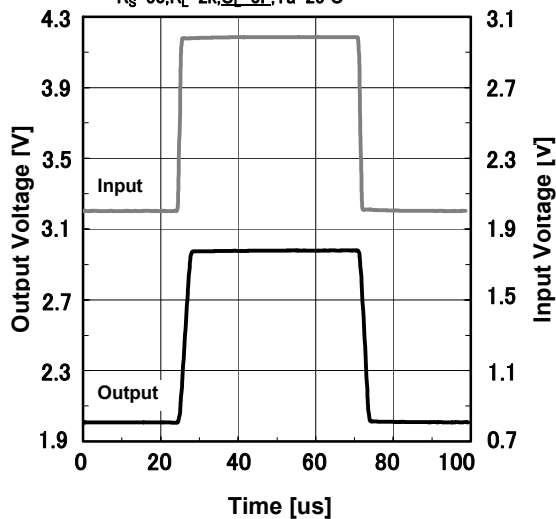

Pulse Response(Rise) (Temp.)

$V^+=5V, V_{in}=1V_{p-p}, f=10kHz,$
 $G_v=0dB, R_s=50, R_l=2k, C_l=0F$

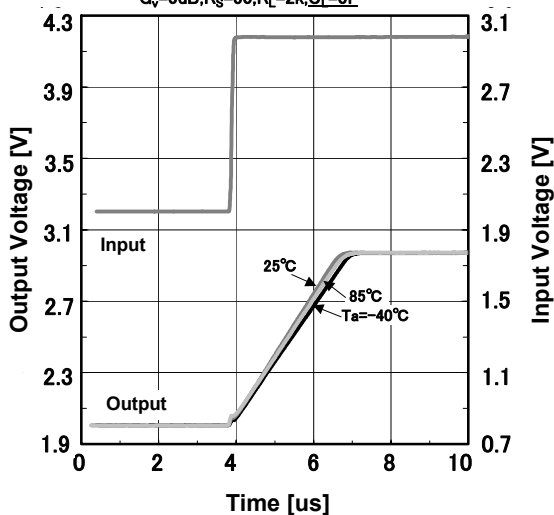

Pulse Response(Fall) (Temp.)

$V^+=5V, V_{in}=1V_{p-p}, f=10kHz,$
 $G_v=0dB, R_s=50, R_l=2k, C_l=0F$

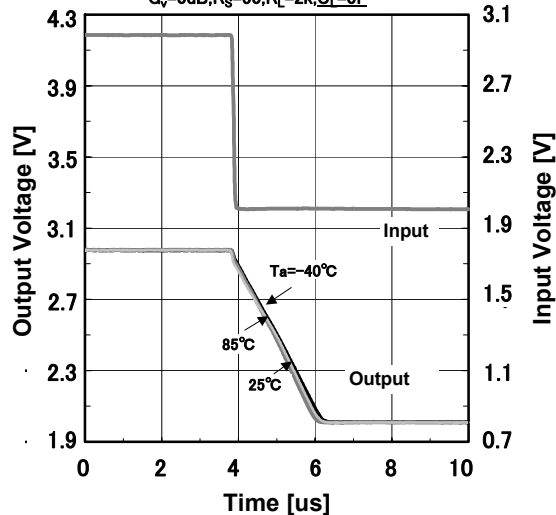

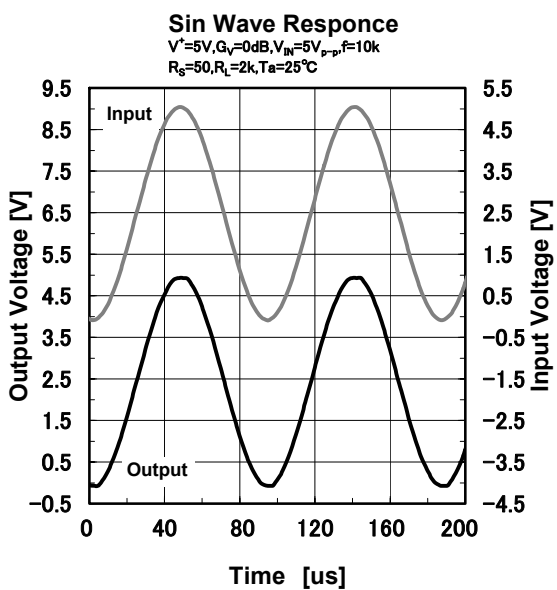
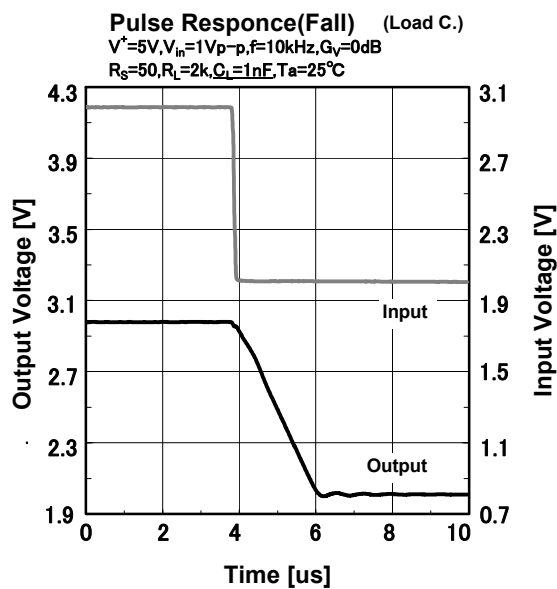
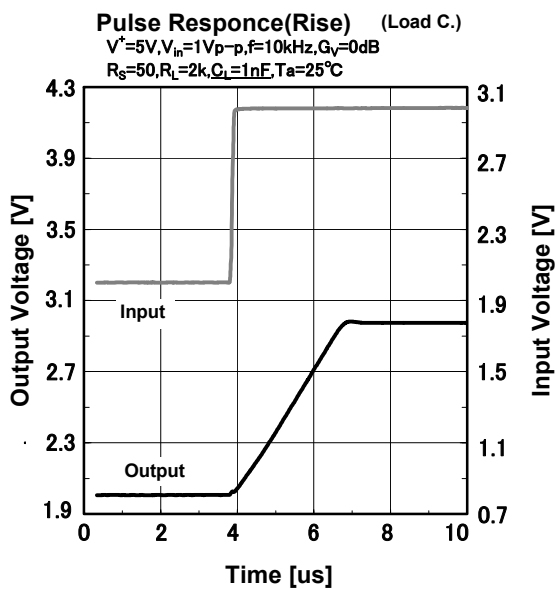
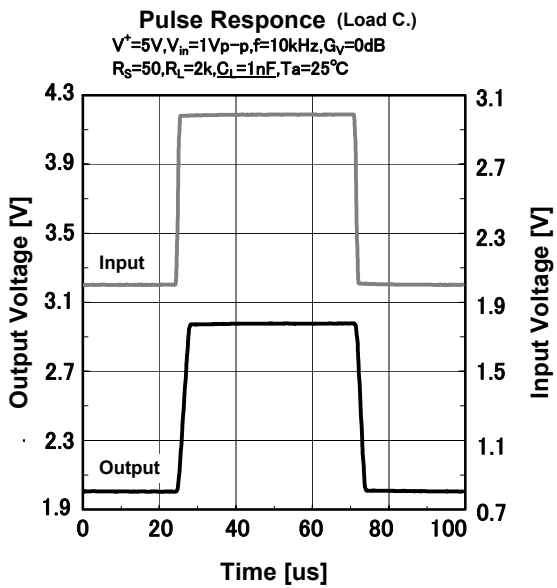

■ MEMO

[CAUTION]

The specifications on this databook are only given for information, without any guarantee as regards either mistakes or omissions. The application circuits in this databook are described only to show representative usages of the product and not intended for the guarantee or permission of any right including the industrial rights.