



Chipsmall Limited consists of a professional team with an average of over 10 year of expertise in the distribution of electronic components. Based in Hongkong, we have already established firm and mutual-benefit business relationships with customers from,Europe,America and south Asia,supplying obsolete and hard-to-find components to meet their specific needs.

With the principle of "Quality Parts,Customers Priority,Honest Operation,and Considerate Service",our business mainly focus on the distribution of electronic components. Line cards we deal with include Microchip,ALPS,ROHM,Xilinx,Pulse,ON,Everlight and Freescale. Main products comprise IC,Modules,Potentiometer,IC Socket,Relay,Connector.Our parts cover such applications as commercial,industrial, and automotives areas.

We are looking forward to setting up business relationship with you and hope to provide you with the best service and solution. Let us make a better world for our industry!



## Contact us

Tel: +86-755-8981 8866 Fax: +86-755-8427 6832

Email & Skype: info@chipsmall.com Web: www.chipsmall.com

Address: A1208, Overseas Decoration Building, #122 Zhenhua RD., Futian, Shenzhen, China



## LOW DROPOUT VOLTAGE REGULATOR

### ■ GENERAL DESCRIPTION

The NJM2845/46 is low dropout voltage regulator. Advanced Bipolar technology achieves low noise, high ripple rejection and low quiescent current.

NJM2845 is 3 terminal type and NJM2846 is ON/OFF control built in type. These product can be selected according to the applications.

### ■ PACKAGE OUTLINE

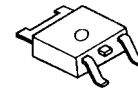

NJM2845DL1

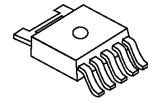

NJM2846DL3

### ■ FEATURES

- High Ripple Rejection           75dB typ. (f=1kHz,3V Version)
- Output Noise Voltage           V<sub>no</sub>=45μVrms typ. (V<sub>o</sub>=3V Version)
- Output capacitor with 2.2μF ceramic capacitor (V<sub>o</sub>≥2.6V)
- Output Current                   I<sub>o</sub>(max.)=800mA
- High Precision Output           V<sub>o</sub> ±1.0%
- Low Dropout Voltage           0.18V typ. (I<sub>o</sub>=500mA)
- ON/OFF Control                 (NJM2846)
- Internal Short Circuit Current Limit
- Internal Thermal Overload Protection
- Bipolar Technology
- Package Outline                 TO-252-3 (NJM2845DL1), TO-252-5 (NJM2846DL3)

### ■ PIN CONFIGURATION

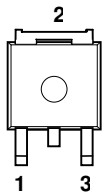

NJM2845DL1

- 1.V<sub>IN</sub>
- 2.GND
- 3.V<sub>OUT</sub>

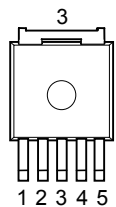

NJM2846DL3

- 1.CONTROL
- 2.V<sub>IN</sub>
- 3.GND
- 4.V<sub>o</sub>
- 5.NC

### ■ EQUIVALENT CIRCUIT

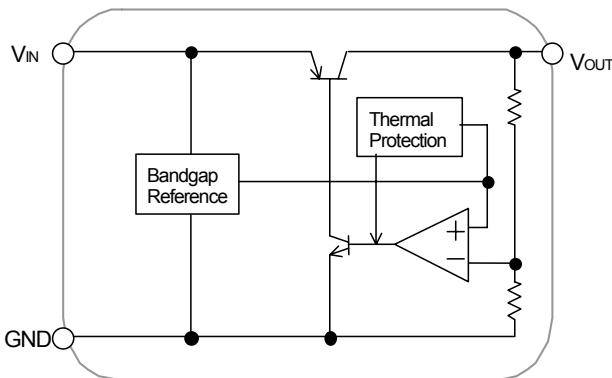

NJM2845DL1

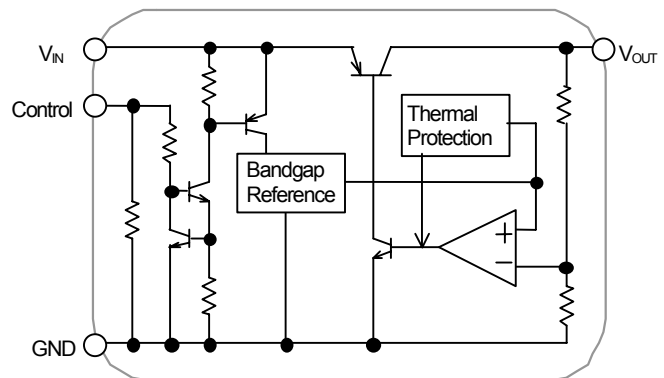

NJM2846DL3

# NJM2845/46

## ■ OUTPUT VOLTAGE

Device Name	V <sub>OUT</sub>
NJM284*DL*-15	1.5V
NJM284*DL*-18	1.8V
NJM284*DL*-02	2.0V
NJM284*DL*-22	2.2V
NJM284*DL*-23	2.3V
NJM284*DL*-25	2.5V
NJM284*DL*-03	3.0V
NJM284*DL*-33	3.3V
NJM284*DL*-04	4.0V
NJM284*DL*-05	5.0V

Output voltage options available : 1.5 ~ 5.0V (0.1V step)

## ■ ABSOLUTE MAXIMUM RATINGS (Ta=25°C)

PARAMETER	SYMBOL	RATINGS	UNIT
Input Voltage	V <sub>IN</sub>	+14	V
Control Voltage	V <sub>CONT</sub>	+14(*1)	V
Power Dissipation	P <sub>D</sub>	10(Tc≤25°C) 1.0(Ta≤25°C)	W
Operating Temperature	Topr	-40 ~ +85	°C
Storage Temperature	Tstg	-40 ~ +150	°C

(\*1): When input voltage is less than +14V, the absolute maximum control voltage is equal to the input voltage.

## ■ Operating voltage

$$V_{IN}=+2.5V(\text{In case of } V_o<2.3V) \sim +(V_o+9V)$$

## ■ NJM2845

## ■ ELECTRICAL CHARACTERISTICS

(V<sub>IN</sub>=V<sub>o</sub>+1V, C<sub>IN</sub>=0.33μF, C<sub>o</sub>=2.2μF(1.7V<V<sub>o</sub>≤2.6V:C<sub>o</sub>=4.7μF, V<sub>o</sub>≤1.7V: C<sub>o</sub>=10μF), Ta=25°C)

PARAMETER	SYMBOL	TEST CONDITION	MIN.	TYP.	MAX.	UNIT
Output Voltage	V <sub>o</sub>	I <sub>o</sub> =30mA	-1.0%	-	+1.0%	V
Quiescent Current	I <sub>Q</sub>	I <sub>o</sub> =0mA	-	400	600	μA
Output Current	I <sub>o</sub>	V <sub>o</sub> - 0.3V	800	1050	-	mA
Line Regulation	ΔV <sub>o</sub> /ΔV <sub>IN</sub>	V <sub>IN</sub> =V <sub>o</sub> +1V ~ V <sub>o</sub> +6V, I <sub>o</sub> =30mA	-	-	0.10	%/V
Load Regulation	ΔV <sub>o</sub> /ΔI <sub>o</sub>	I <sub>o</sub> =0 ~ 800mA	-	-	0.004	%/mA
Dropout Voltage(*2)	ΔV <sub>I-O</sub>	I <sub>o</sub> =500mA	-	0.18	0.28	V
Ripple Rejection	RR	e <sub>in</sub> =200mVrms, f=1kHz, I <sub>o</sub> =10mA, V <sub>o</sub> =3V Version	-	75	-	dB
Average Temperature Coefficient of Output Voltage	ΔV <sub>o</sub> /ΔTa	Ta=0 ~ 85°C, I <sub>o</sub> =10mA	-	± 50	-	ppm/°C
Output Noise Voltage	V <sub>NO</sub>	f=10Hz ~ 80kHz, I <sub>o</sub> =10mA, V <sub>o</sub> =3V Version	-	45	-	μVrms

(\*2): The output voltage excludes under 2.3V.

The above specification is a common specification for all output voltages.

Therefore, it may be different from the individual specification for a specific output voltage.

## POWER DISSIPATION vs. AMBIENT TEMPERATURE

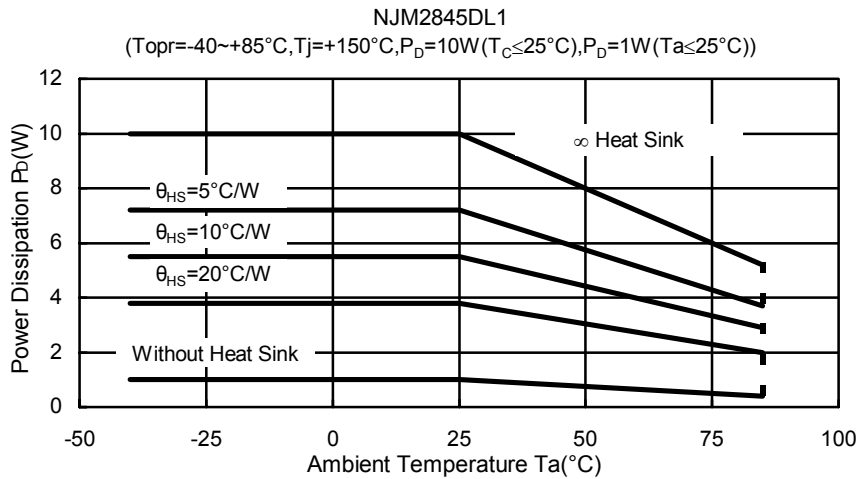

## TEST CIRCUIT

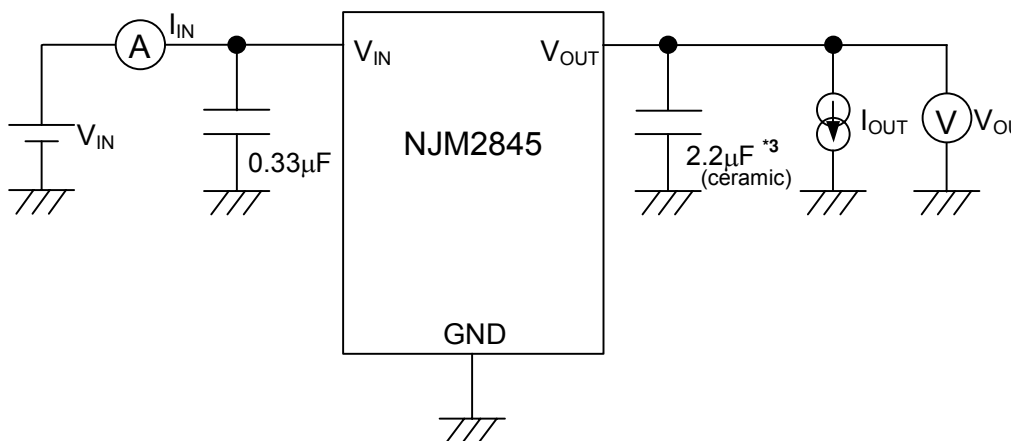

\*3 1.7V <  $V_o$  ≤ 2.6V version:  $C_o = 4.7\mu\text{F}$ ,  $V_o \leq 1.7\text{V}$ :  $C_o = 10\mu\text{F}$  (ceramic)

## TYPICAL APPLICATION

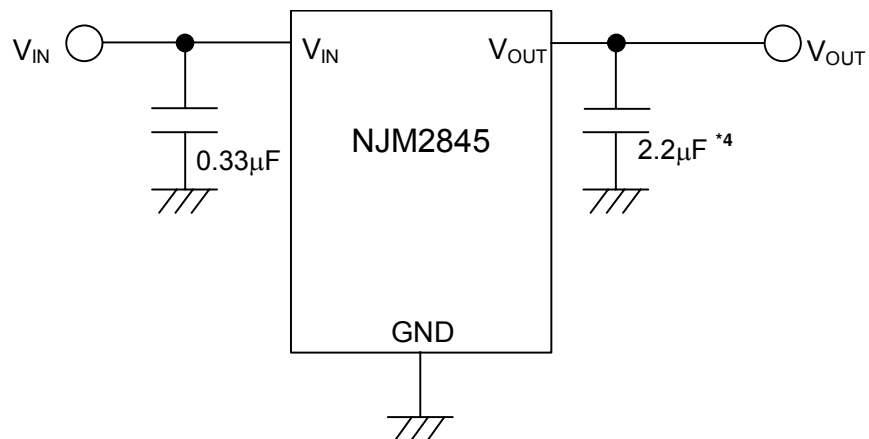

\*4 1.7V <  $V_o$  ≤ 2.6V version:  $C_o = 4.7\mu\text{F}$ ,  $V_o \leq 1.7\text{V}$ :  $C_o = 10\mu\text{F}$

# NJM2845/46

## ■ NJM2846

### ■ ELECTRICAL CHARACTERISTICS

( $V_{IN}=V_o+1V$ ,  $C_{IN}=0.33\mu F$ ,  $C_o=2.2\mu F$  (1.7V< $V_o\leq 2.6V$  version:  $C_o=4.7\mu F$ ,  $V_o\leq 1.7V$ :  $C_o=10\mu F$ ),  $T_a=25^\circ C$ )

PARAMETER	SYMBOL	TEST CONDITION	MIN.	TYP.	MAX.	UNIT
Output Voltage	$V_o$	$I_o=30mA$	-1.0%	-	+1.0%	V
Quiescent Current	$I_Q$	$I_o=0mA$	-	400	600	$\mu A$
Quiescent Current at Control OFF	$I_{Q(OFF)}$	$V_{CONT}=0V$	-	-	100	nA
Line Regulation	$I_o$	$V_o - 0.3V$	800	1050	-	mA
Line Regulation	$\Delta V_o/\Delta V_{IN}$	$V_{IN}=V_o+1V \sim V_o+6V$ , $I_o=30mA$	-	-	0.10	%/V
Load Regulation	$\Delta V_o/\Delta I_o$	$I_o=0 \sim 800mA$	-	-	0.004	%/mA
Dropout Voltage(*5)	$\Delta V_{I-O}$	$I_o=500mA$	-	0.18	0.28	V
Ripple Rejection	RR	$e_{in}=200mV_{rms}$ , $f=1kHz$ , $I_o=10mA$ , $V_o=3V$ Version	-	75	-	dB
Average Temperature Coefficient of Output Voltage	$\Delta V_o/\Delta T_a$	$T_a=0 \sim 85^\circ C$ , $I_o=10mA$	-	$\pm 50$	-	ppm/ $^\circ C$
Output Noise Voltage	$V_{NO}$	$f=10Hz \sim 80kHz$ , $I_o=10mA$ , $V_o=3V$ Version	-	45	-	$\mu V_{rms}$
Control Current	$I_{CONT}$	$V_{CONT}=1.6V$ , $I_o=0mA$	-	3	12	$\mu A$
Control Voltage for ON-state	$V_{CONT(ON)}$		1.6	-	-	V
Control Voltage for OFF-state	$V_{CONT(OFF)}$		-	-	0.6	V

(\*5): The output voltage excludes under 2.3V.

The above specification is a common specification for all output voltages.

Therefore, it may be different from the individual specification for a specific output voltage.

### ■ POWER DISSIPATION vs. AMBIENT TEMPERATURE

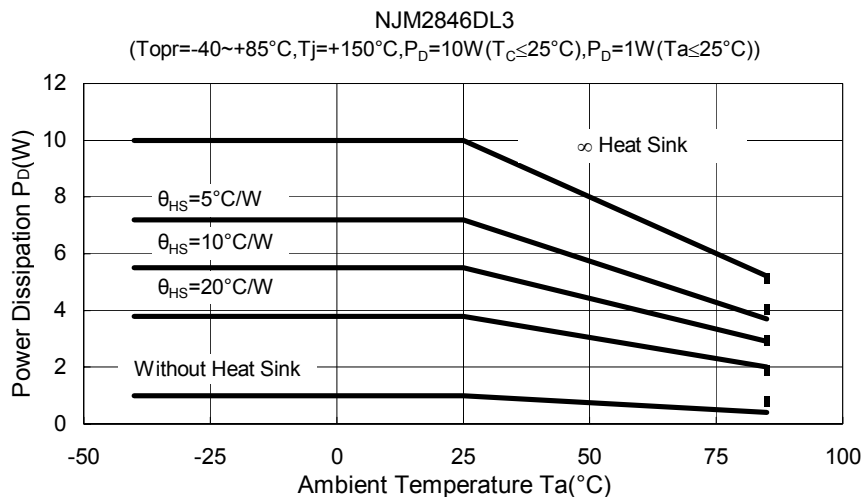

## ■ TEST CIRCUIT

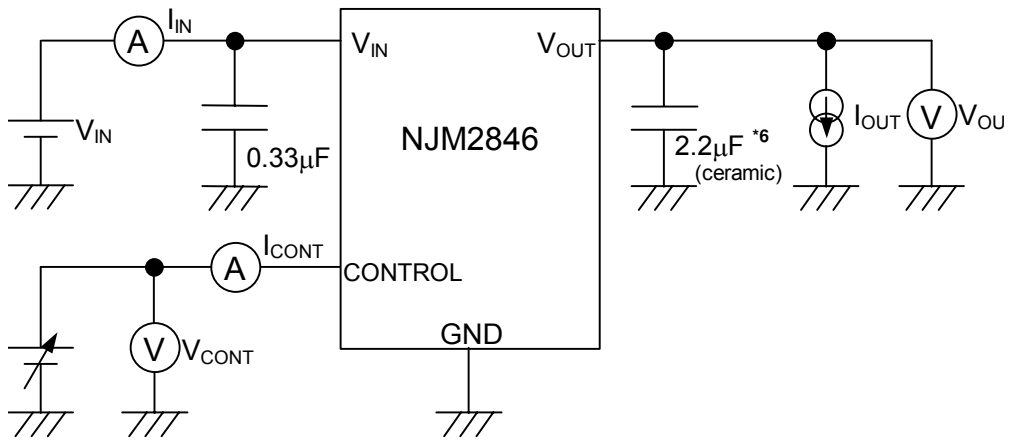

\*6  $1.7\text{V} < V_o \leq 2.6\text{V}$  version:  $C_o = 4.7\mu\text{F}$ ,  $V_o \leq 1.7\text{V}$ :  $C_o = 10\mu\text{F}$

# NJM2845/46

## ■ TYPICAL APPLICATIONS

① In the case where ON/OFF Control is not required:

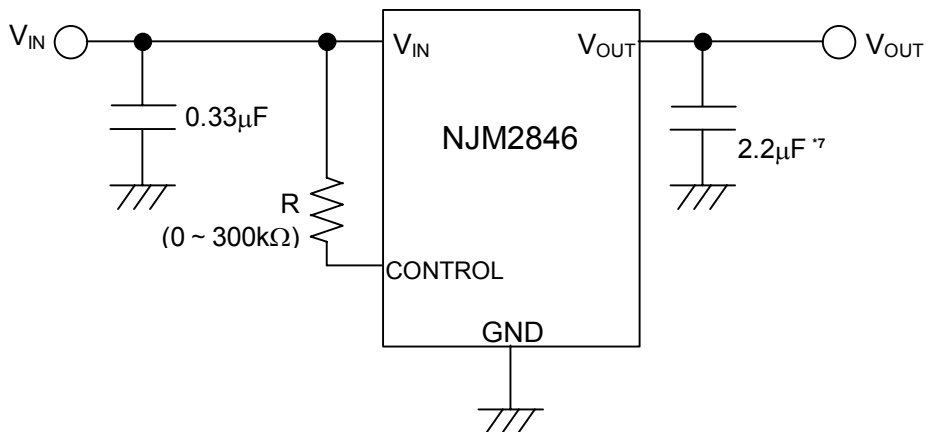

\*7 1.7V<V<sub>O</sub>≤2.6V version: C<sub>O</sub>=4.7µF, V<sub>O</sub>≤1.7V: C<sub>O</sub>=10µF

Connect control terminal to V<sub>IN</sub> terminal

② In use of ON/OFF CONTROL:

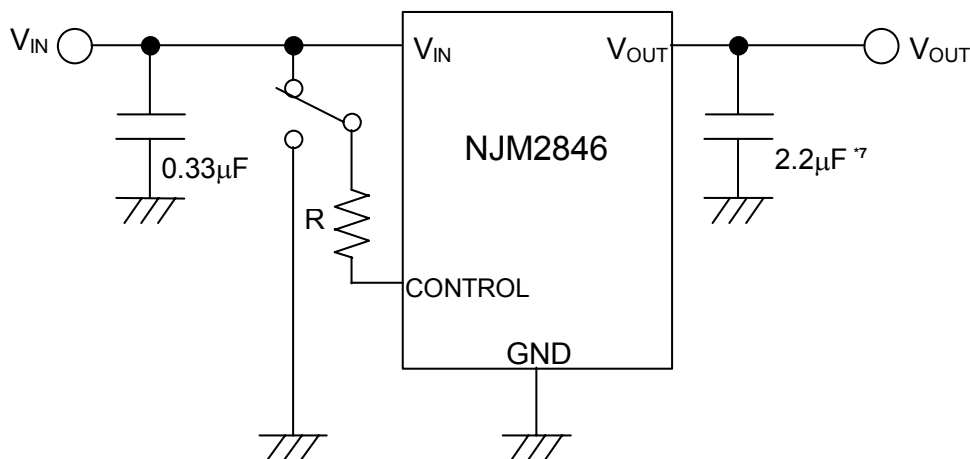

\*7 1.7V<V<sub>O</sub>≤2.6V version: C<sub>O</sub>=4.7µF, V<sub>O</sub>≤1.7V: C<sub>O</sub>=10µF

State of control terminal:

- “H”→ output is enabled.
- “L” or “open” → output is disabled.

\*In the case of using a resistance "R" between V<sub>IN</sub> and control.

The current flow into the control terminal while the IC is ON state (I<sub>CONT</sub>) can be reduced when a pull up resistance "R" is inserted between V<sub>IN</sub> and the control terminal.

The minimum control voltage for ON state (V<sub>CONT(ON)</sub>) is increased due to the voltage drop caused by I<sub>CONT</sub> and the resistance "R". The I<sub>CONT</sub> is temperature dependence as shown in the "Control Current vs. Temperature" characteristics. Therefore, the resistance "R" should be carefully selected to ensure the control voltage exceeds the V<sub>CONT(ON)</sub> over the required temperature range.

## \*Input Capacitance $C_{IN}$

Input capacitance  $C_{IN}$  is required to prevent oscillation and reduce power supply ripple for applications with high power supply impedance or a long power supply line.

Use the  $C_{IN}$  value of 0.33 $\mu$ F greater to avoid the problem.

$C_{IN}$  should connect between GND and  $V_{IN}$  as short as possible.

## \*Output Capacitance $C_O$

Output capacitor ( $C_O$ ) is required for a phase compensation of the internal error amplifier. The capacitance and the equivalent series resistance (ESR) influences stability of the regulator.

This product is designed to work with a low ESR capacitor for the  $C_O$ ; however, use of recommended capacitance or greater value is essential for stable operation.

Use of a smaller  $C_O$  may cause excess output noise or oscillation of the regulator due to lack of the phase compensation.

Therefore, use  $C_O$  with the recommended capacitance or greater value and connect between  $V_O$  terminal and GND terminal with minimal wiring. The recommended capacitance depends on the output voltage. Low voltage regulator requires greater value of the  $C_O$ . Thus, check the recommended capacitance for each output voltage.

Use of a greater  $C_O$  reduces output noise and ripple output, and also improves transient response of the output voltage against rapid load change.



# NJM2845/46

## ■ TYPICAL CHARACTERISTICS (NJM2845)

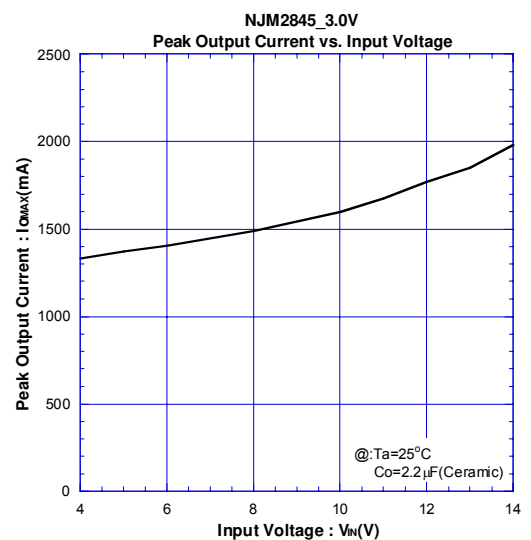
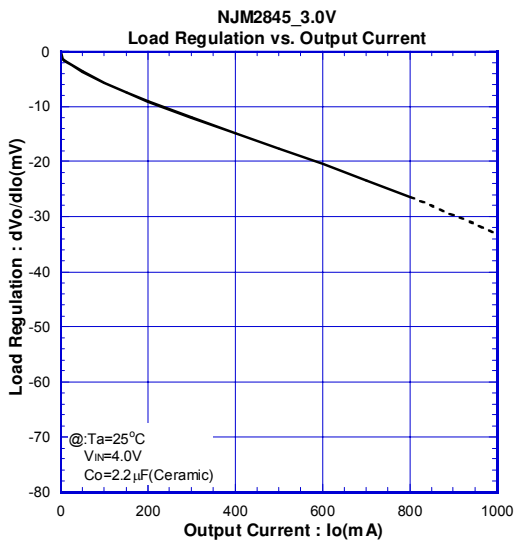
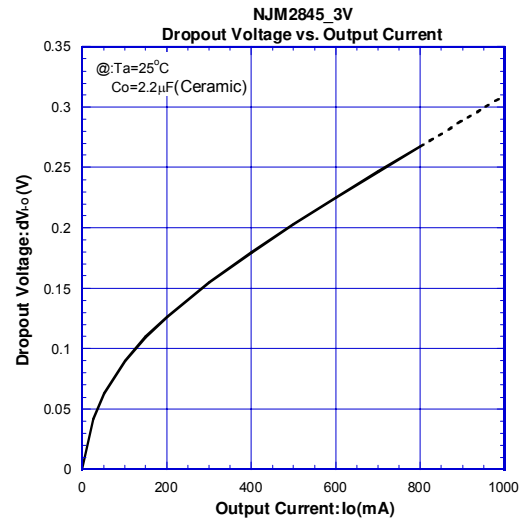
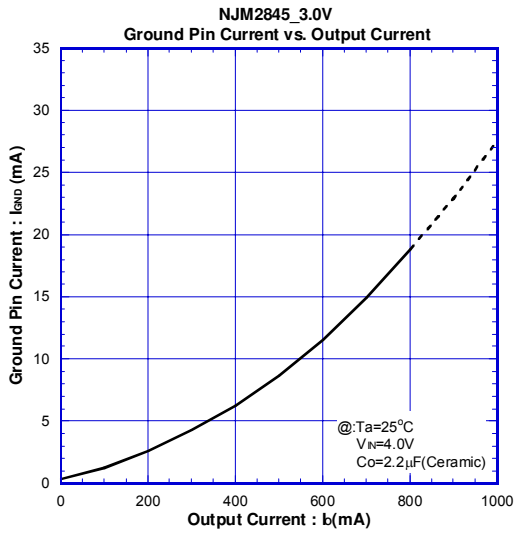
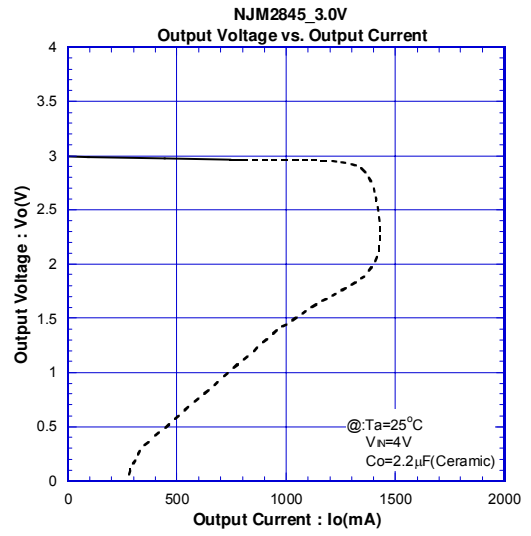
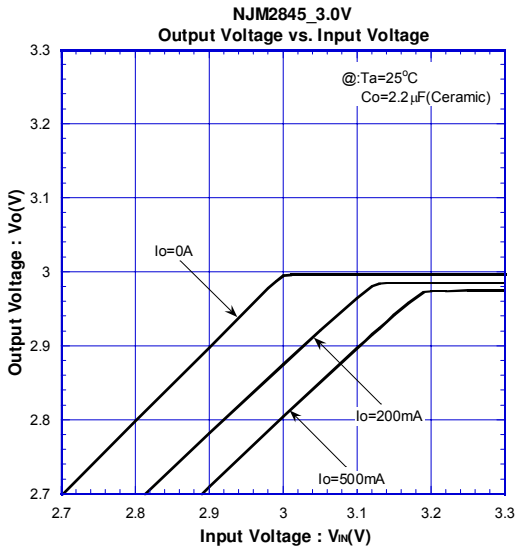

## TYPICAL CHARACTERISTICS (NJM2845)

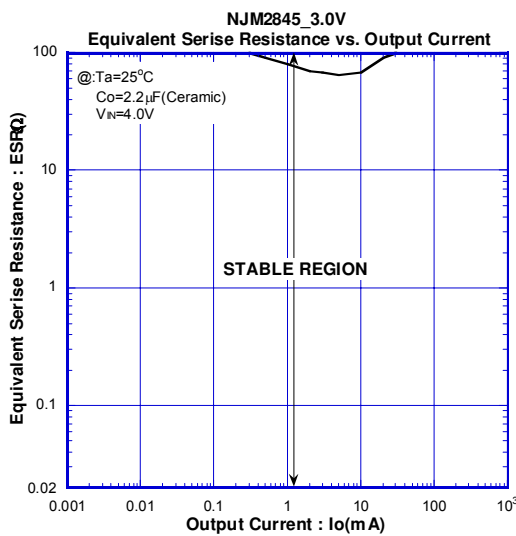
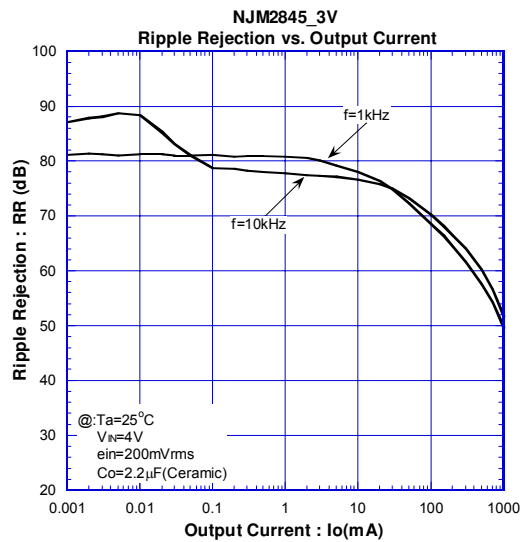
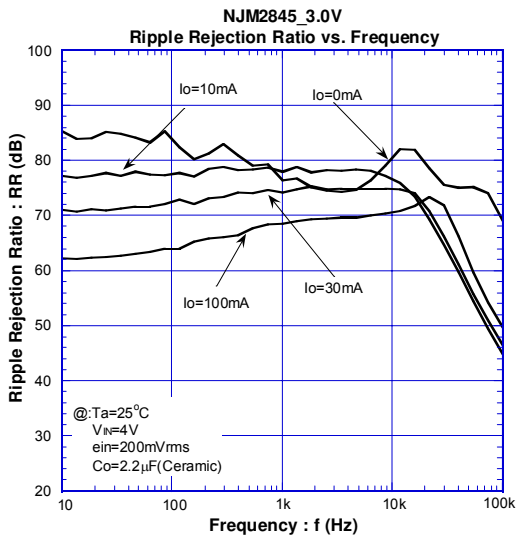
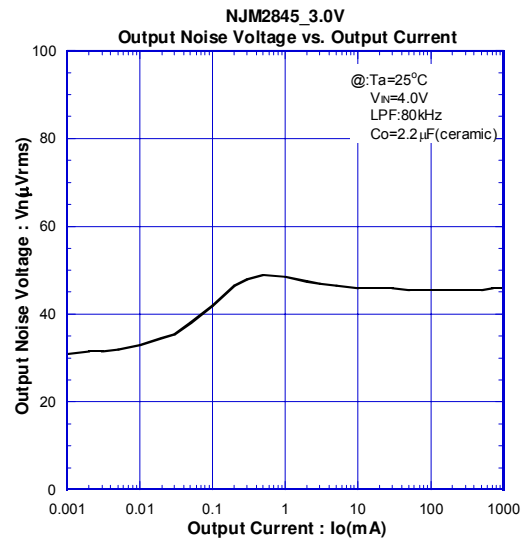
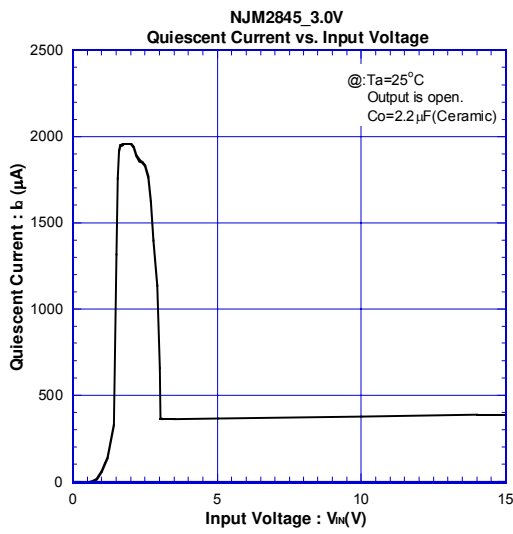

# NJM2845/46

## ■ TYPICAL CHARACTERISTICS (NJM2845)

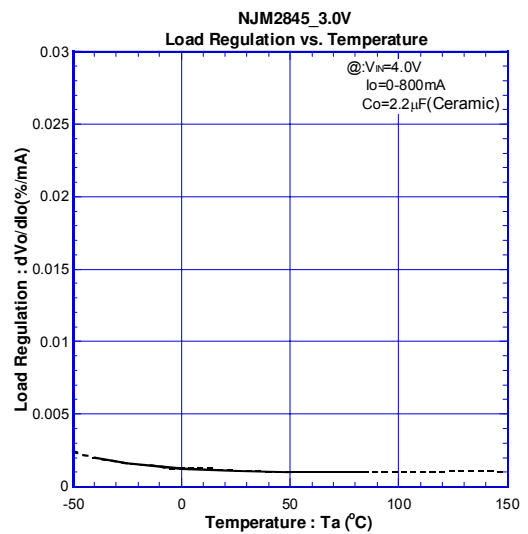
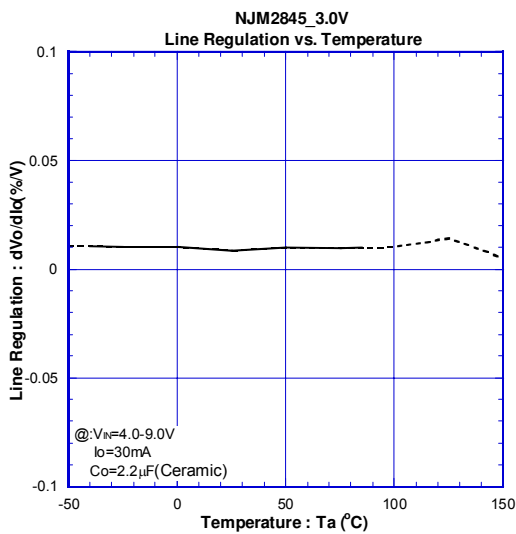
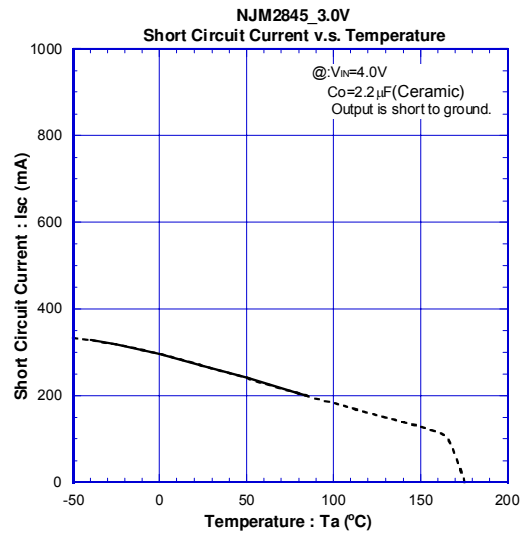
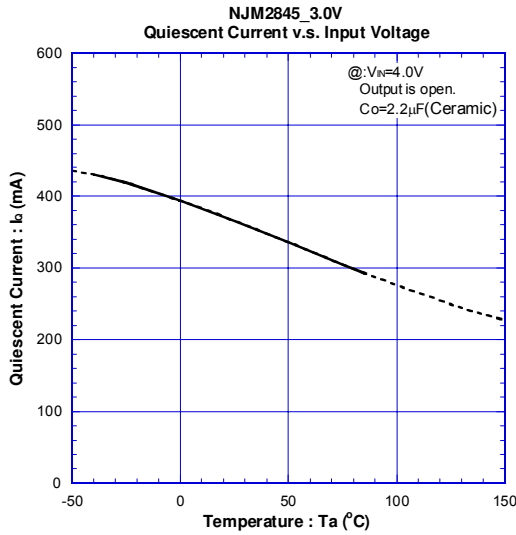
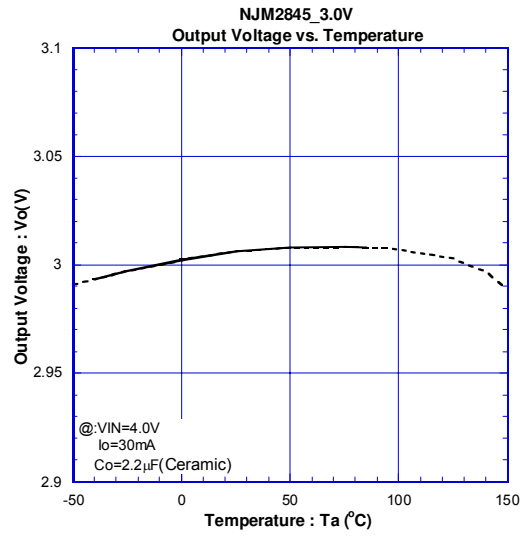
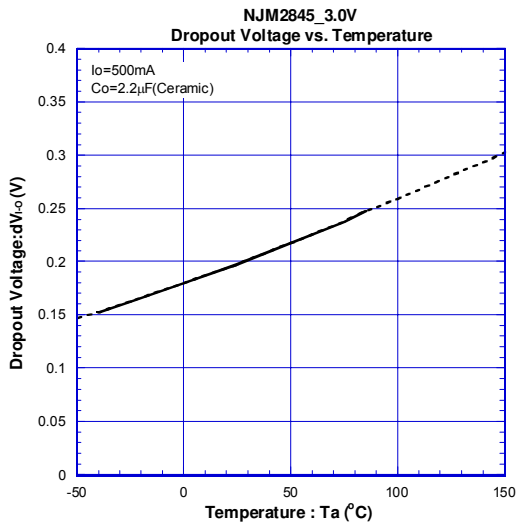

## ■ TYPICAL CHARACTERISTICS (NJM2845)

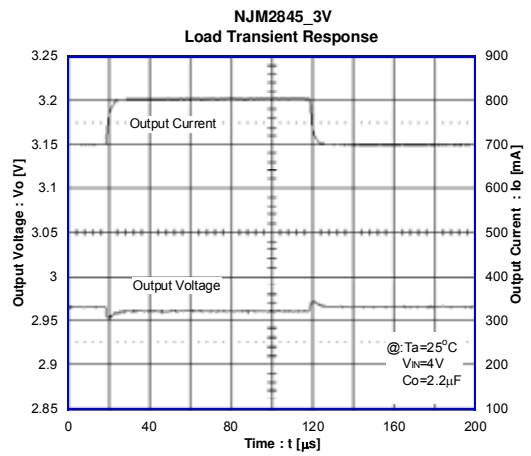
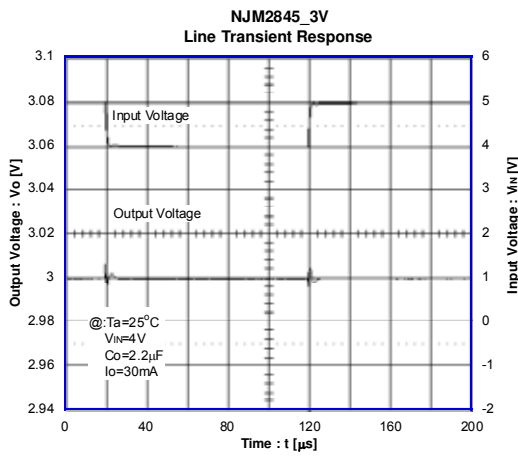
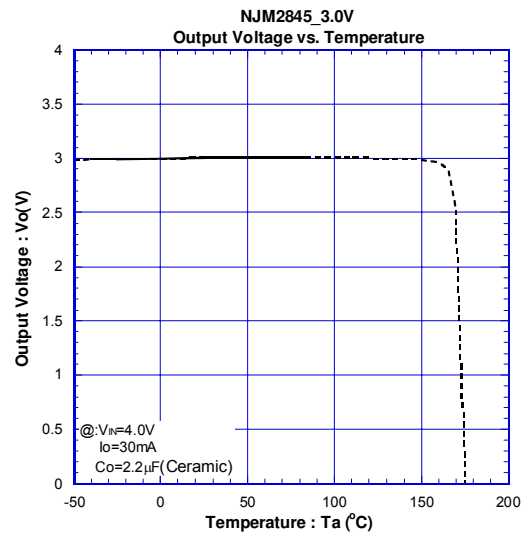
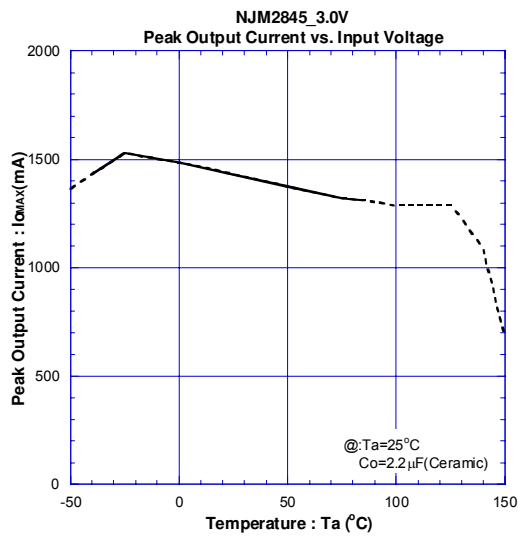

# NJM2845/46

## ■ TYPICAL CHARACTERISTICS (NJM2846)

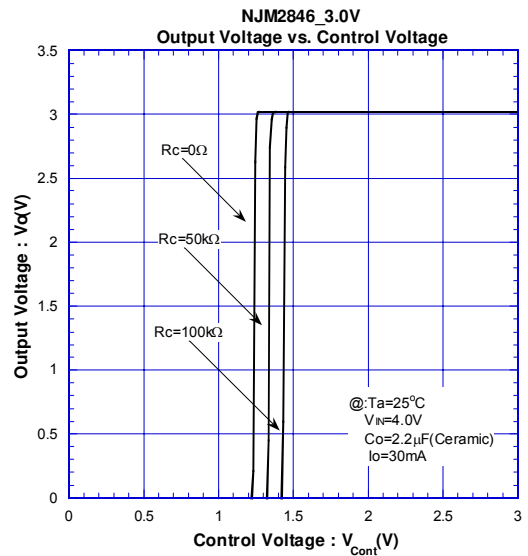
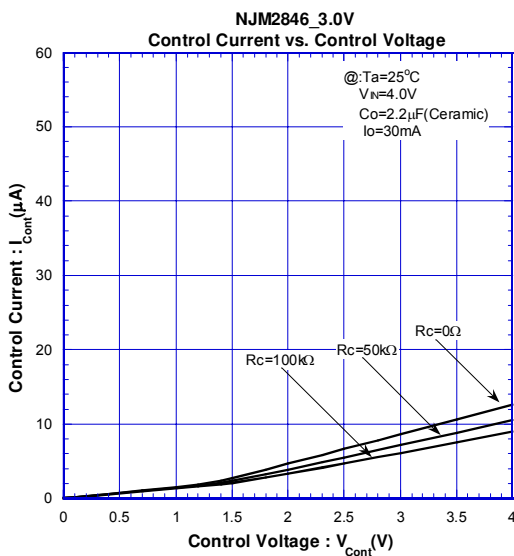
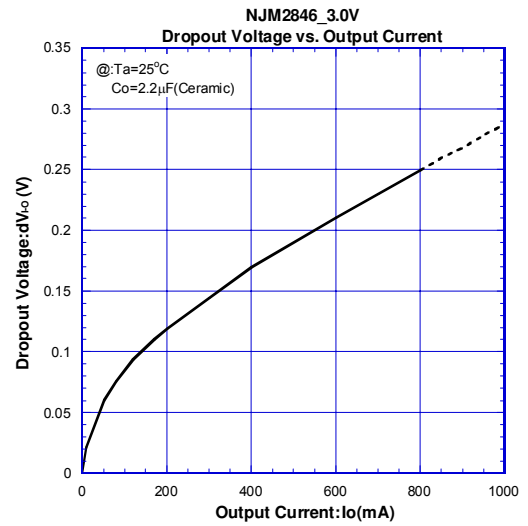
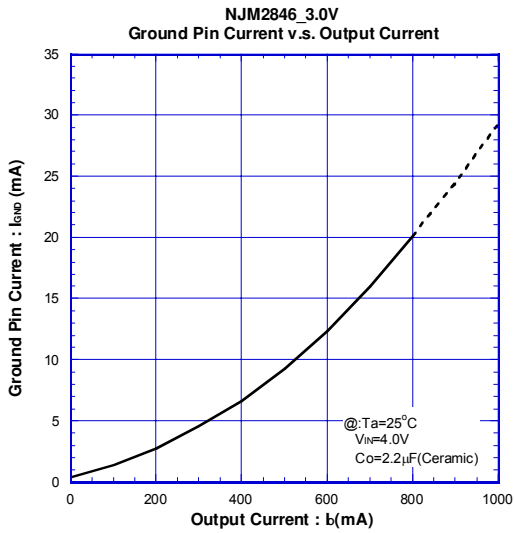
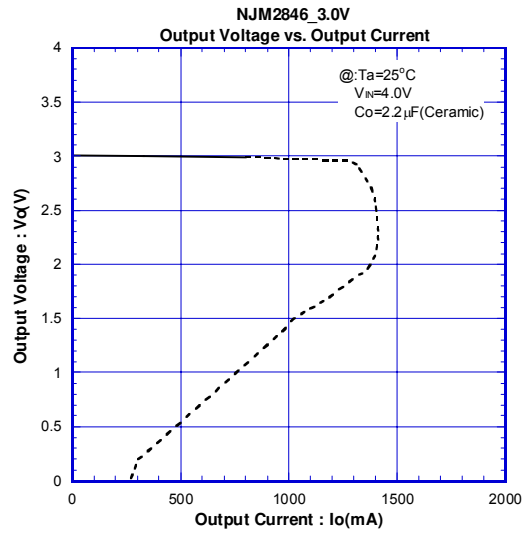
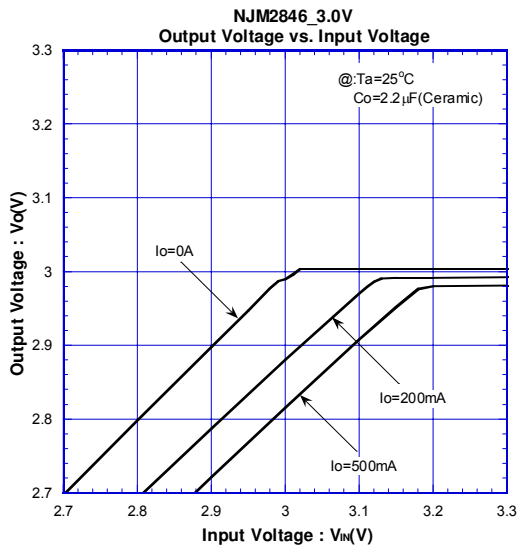

## ■ TYPICAL CHARACTERISTICS (NJM2846)

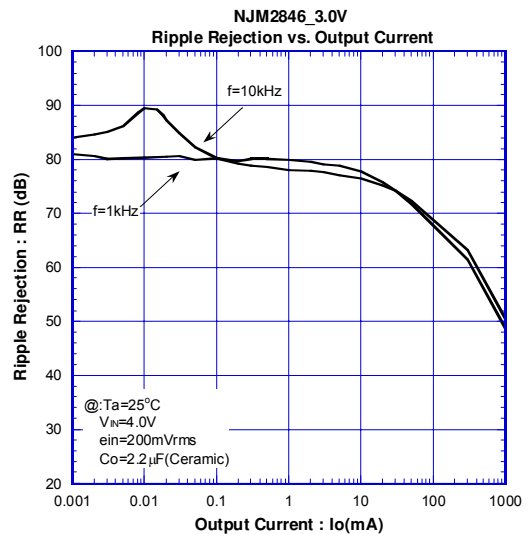
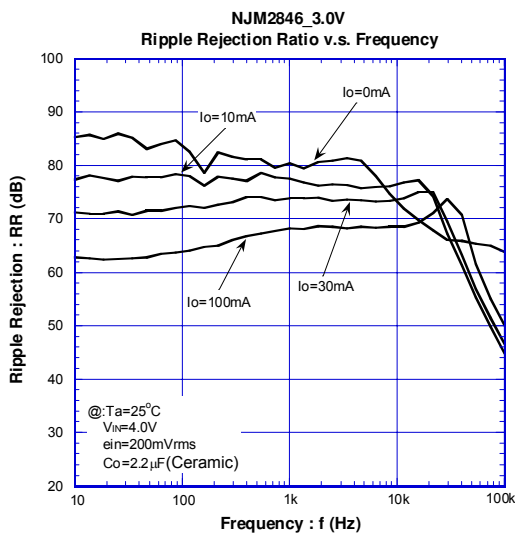
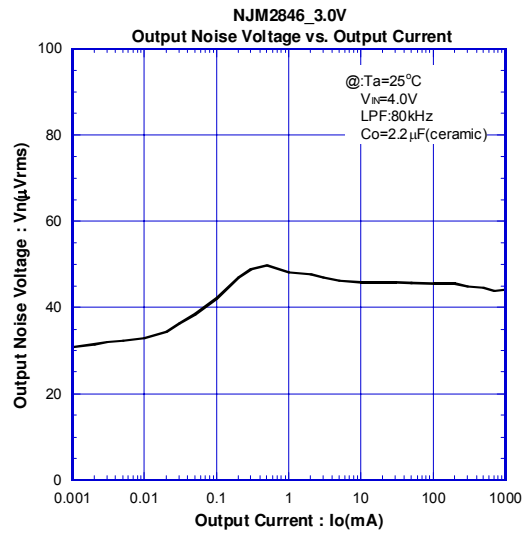
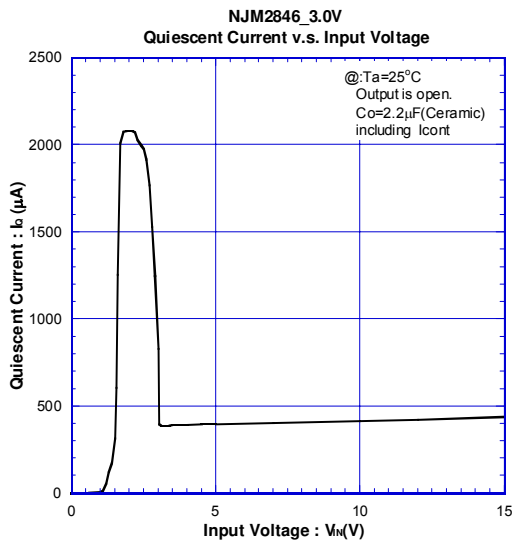
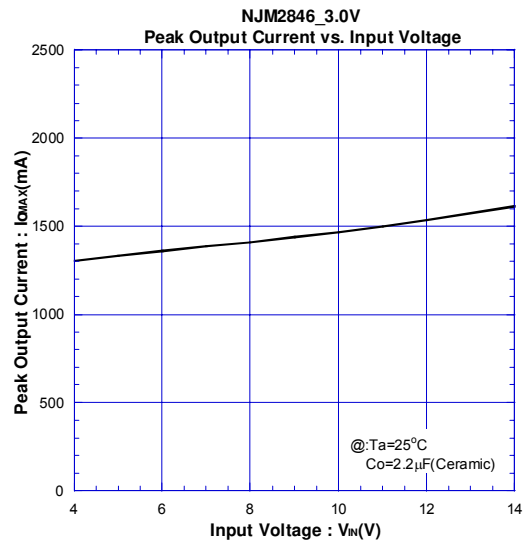
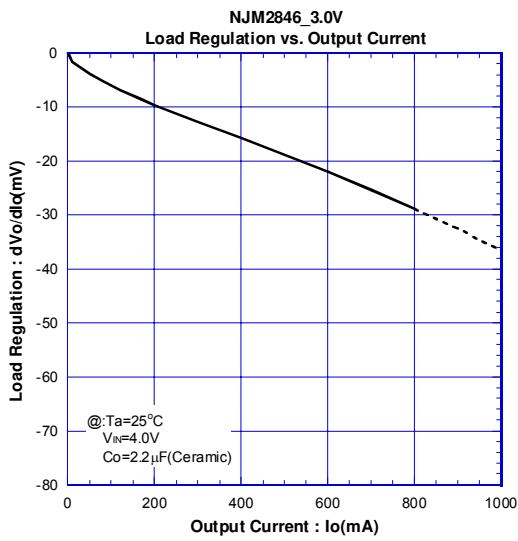

# NJM2845/46

## ■ TYPICAL CHARACTERISTICS (NJM2846)

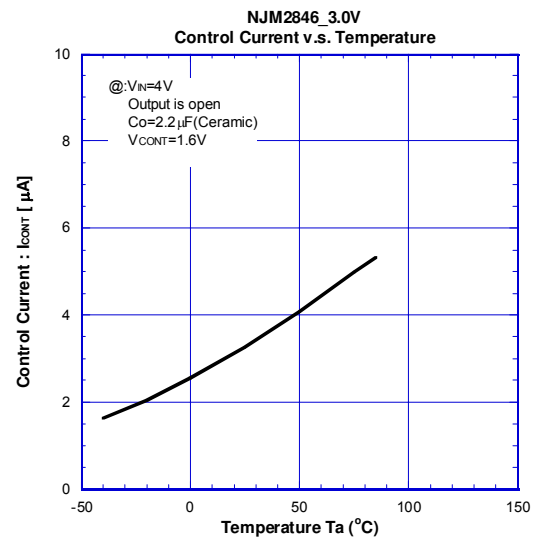
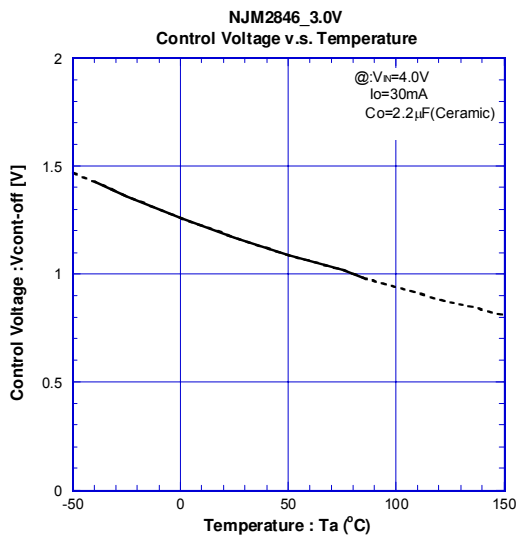
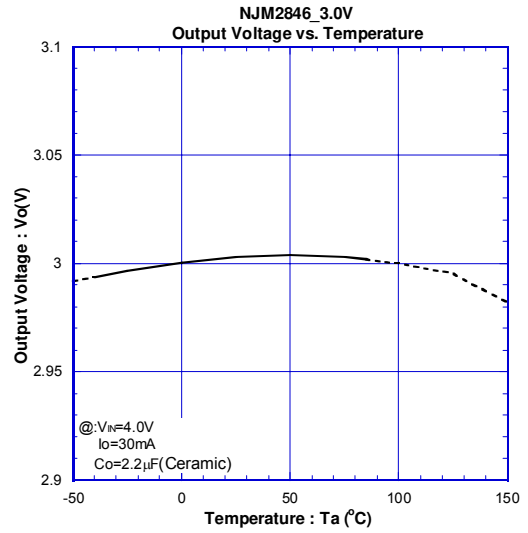
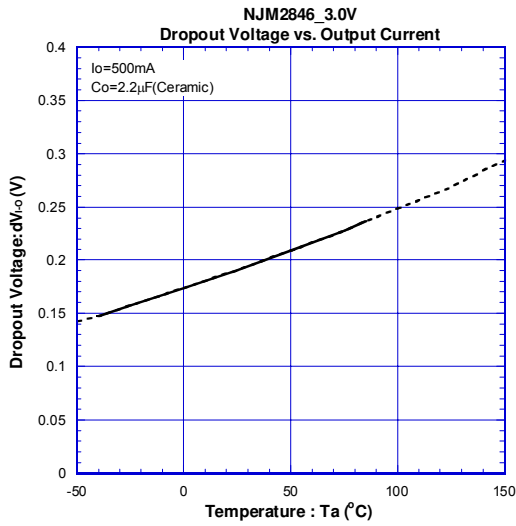
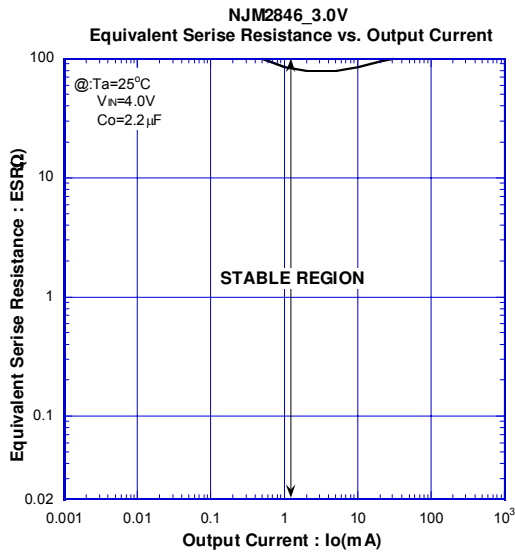

## ■ TYPICAL CHARACTERISTICS (NJM2846)

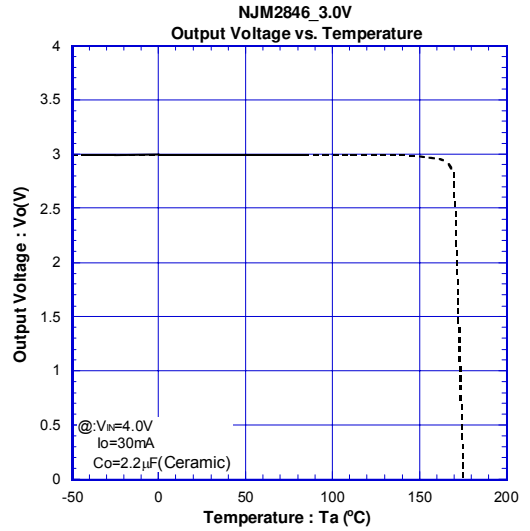
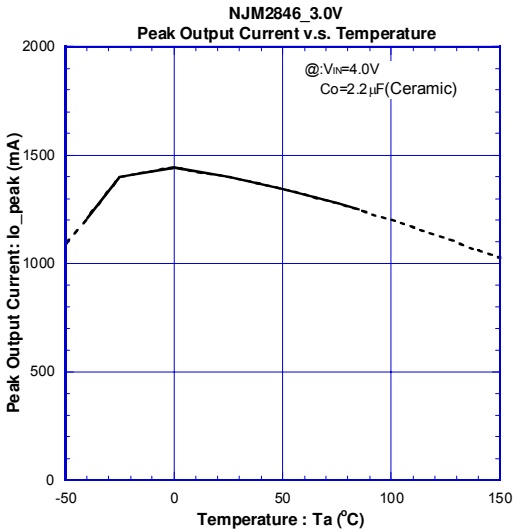
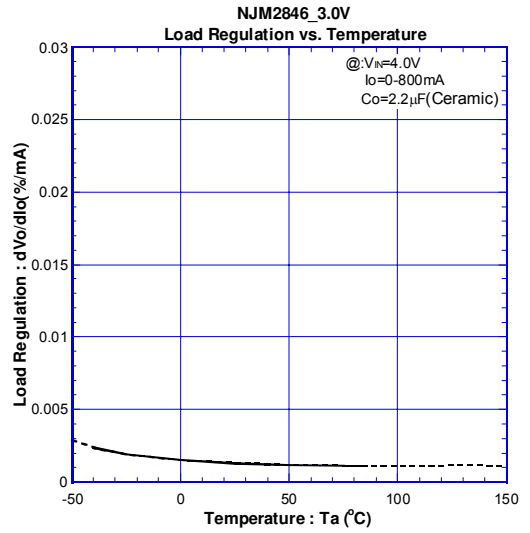
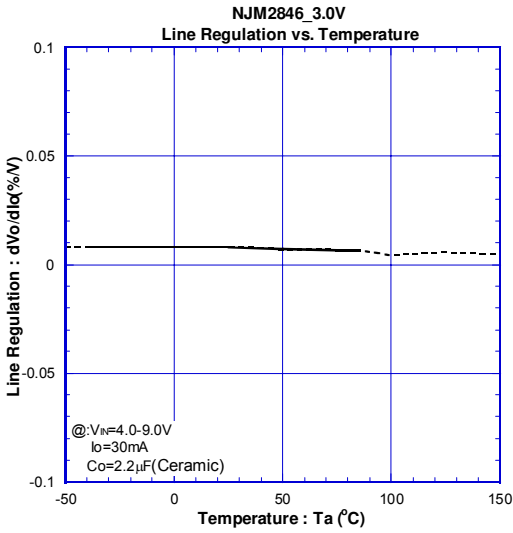
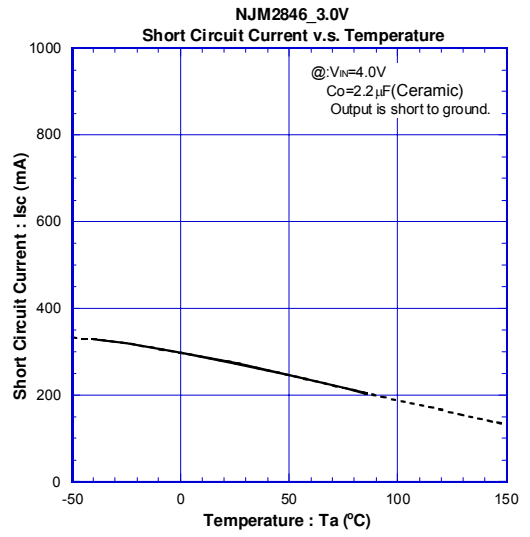
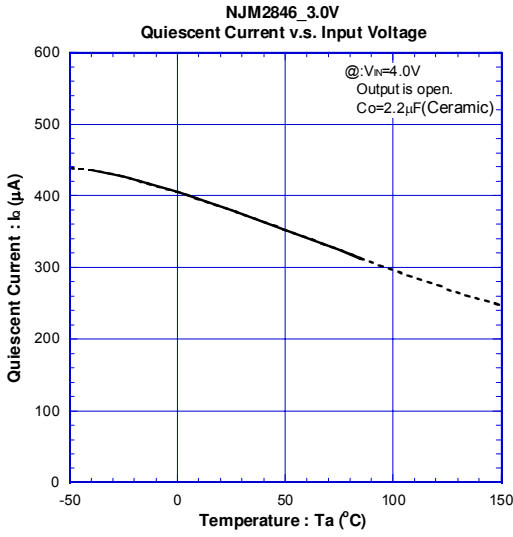



# NJM2845/46

## ■ TYPICAL CHARACTERISTICS (NJM2846)

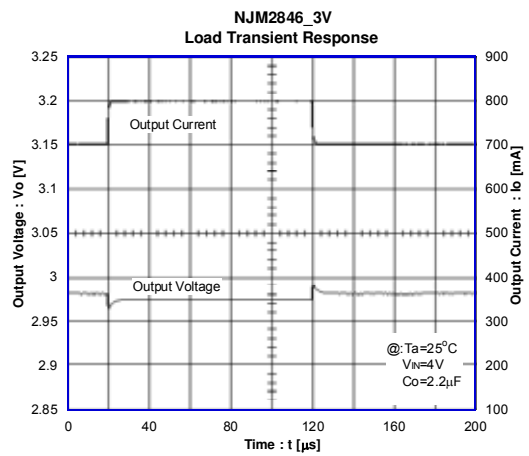
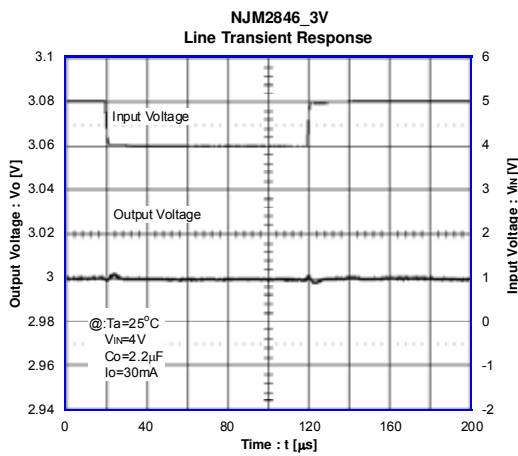
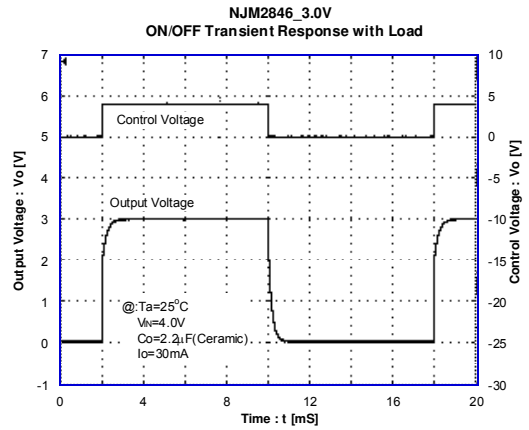
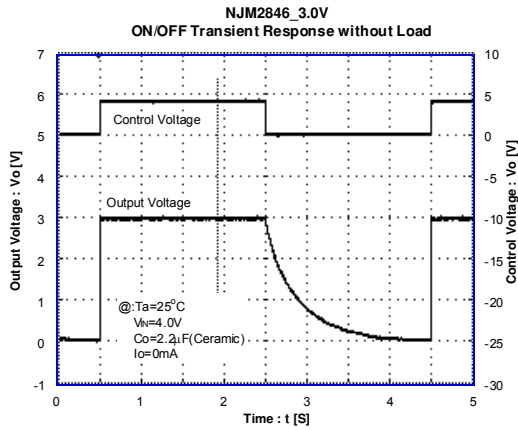

**[CAUTION]**  
The specifications on this databook are only given for information, without any guarantee as regards either mistakes or omissions. The application circuits in this databook are described only to show representative usages of the product and not intended for the guarantee or permission of any right including the industrial rights.