



Chipsmall Limited consists of a professional team with an average of over 10 year of expertise in the distribution of electronic components. Based in Hongkong, we have already established firm and mutual-benefit business relationships with customers from,Europe,America and south Asia,supplying obsolete and hard-to-find components to meet their specific needs.

With the principle of "Quality Parts,Customers Priority,Honest Operation,and Considerate Service",our business mainly focus on the distribution of electronic components. Line cards we deal with include Microchip,ALPS,ROHM,Xilinx,Pulse,ON,Everlight and Freescale. Main products comprise IC,Modules,Potentiometer,IC Socket,Relay,Connector.Our parts cover such applications as commercial,industrial, and automotives areas.

We are looking forward to setting up business relationship with you and hope to provide you with the best service and solution. Let us make a better world for our industry!



## Contact us

Tel: +86-755-8981 8866 Fax: +86-755-8427 6832

Email & Skype: info@chipsmall.com Web: www.chipsmall.com

Address: A1208, Overseas Decoration Building, #122 Zhenhua RD., Futian, Shenzhen, China



LOW VOLTAGE AUDIO POWER AMPLIFIER

■ GENERAL DESCRIPTION

The NJM386B is wider operating voltage and higher output power version of NJM386. The maximum operating voltage is 18V, and the maximum output power is up to 1W.

■ FEATURES

- Operating Voltage (4V~18V)
- Minimum External Components
- Low Operating Current (5mA)
- Voltage Gain (20~200)
- Single Supply Operation
- Self-centering of Output Offset Voltage
- Package Outline DIP8, SIP8, DMP8
- Bipolar Technology

■ PACKAGE OUTLINE

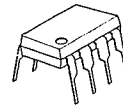

NJM386BD



NJM386BM

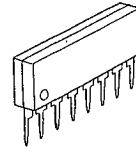

NJM386BL

■ APPLICATIONS

- AM-FM radio amplifiers
- Portable tape player amplifiers
- Intercoms
- TV sound systems
- Line drivers
- Ultra-sonic Drivers
- Small servo drivers
- Power converters

■ PIN CONFIGURATION

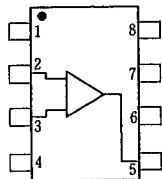

NJM386BD  
NJM386BM

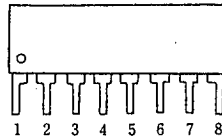

NJM386BL

PIN FUNCTION

1. GAIN
2. -INPUT
3. +INPUT
4. GND
5. OUTPUT
6. V<sup>+</sup>
7. BY PASS
8. GAIN

■ EQUIVALENT CIRCUIT

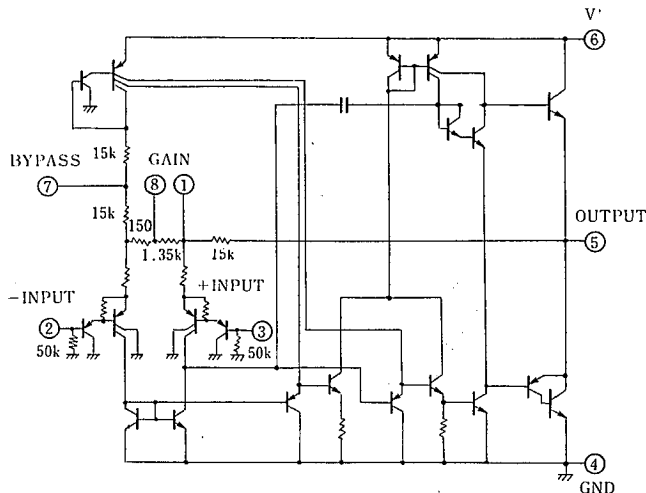

## ■ ABSOLUTE MAXIMUM RATINGS

(Ta=25°C)

PARAMETER	SYMBOL	RATINGS	UNIT
Supply Voltage	V+	22	V
Power Dissipation	P <sub>D</sub>	(DIP-8) 700	mW
		(SIP-8) 800	mW
		(DMP-8) 300	mW
Input Voltage Range	V <sub>IN</sub>	±0.4	V
Operating Temperature Range	T <sub>opr</sub>	-40 ~ +85	°C
Storage Temperature Range	T <sub>stg</sub>	-40 ~ +125	°C

## ■ ELECTRICAL CHARACTERISTICS

(Ta=25°C)

PARAMETER	SYMBOL	TEST CONDITION	MIN.	TYP.	MAX.	UNIT
Operating Voltage	V+		4	—	18	V
Operating Current	I <sub>CC</sub>	V+=6V, V <sub>IN</sub> =0	—	5	8	mA
Output Power	P <sub>O</sub>	V+=6V, R <sub>L</sub> =8Ω, THD=10%	250	325	—	mW
		V+=9V, R <sub>L</sub> =8Ω, THD=10% (note 2)	500	850	—	mW
		V+=16V, R <sub>L</sub> =32Ω, THD=10% (note 1)	700	1000	—	mW
Voltage Gain	A <sub>V</sub>	V <sub>S</sub> =6V, f=1kHz	24	26	28	dB
		10μF from Pin 1 to 8	43	46	49	dB
Bandwidth	BW	V+=6V, Pins 1 and 8 Open	—	600	—	kHz
Total Harmonic Distortion	THD	V+=6V, R <sub>L</sub> =8Ω, P <sub>OUT</sub> =125mV f=1kHz, Pins 1 and 8 Open	—	0.1	—	%
Power supply Rejection Ratio	SVR	V+=6V, f=1kHz, C <sub>BYPASS</sub> =10μF Pins 1 and 8 Open	—	50	—	dB
Input Resistance	R <sub>IN</sub>		—	50	—	kΩ
Input Bias Current	I <sub>b</sub>	V+=6V, Pins 2 and 3 Open	—	100	—	nA

(note 1) NJM386BM: At on Board

(note 2) NJM386BS: At on Board

## ■ TYPICAL APPLICATION

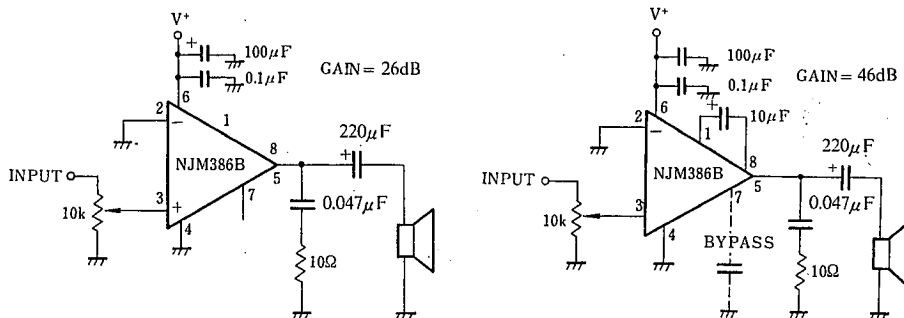

## ■ POWER DISSIPATION VS. AMBIENT TEMPERATURE

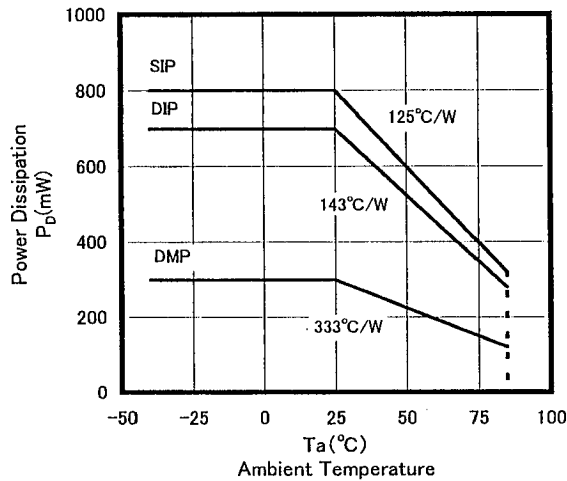

## ■ NOTICE WHEN APPLICATION

### • Prevention of Oscillation

It is recommended to insert capacitors at around the supply source and the GND pins with the value of  $0.1\mu\text{F}$  and more than  $100\mu\text{F}$  which are featuring higher frequency efficiency.

When the speaker load condition, it is recommendable to insert the resistor of  $10\Omega$  and the capacitor of  $0.047\mu\text{F}$  between the output and the GND pins.

### • How to use the Input Resistor (TYP. $50\text{k}\Omega$ )

The input resistors have much deviation in value generally, so that it is recommended not to use them as the constant of the circuit. The countermeasure to be recommended is to apply the resistor of higher in value, which is so higher to be able to ignore the input deviation ( $3\text{k}\Omega$  approximately) in parallel application.

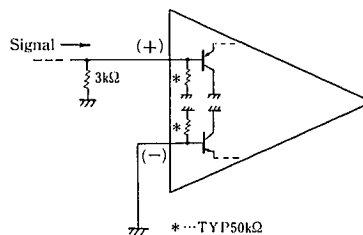

### • Maintenance of Output Offset Voltage

By making connection of both input pins with low value (below  $10\text{k}\Omega$  approximately) to GND, the output offset voltage is automatically set in the medium range value of the supply source. However, the DC Gain of NJM386 is approximately at 20 times in value, so that when keeping one side input pin open, and the other side to GND on DC condition. The voltage drop caused by input resistor  $\times$  input bias current, that is, (input resistor  $\times$  input bias current)  $\times$  20 times voltage is to be sheared, which in the result, no distortion output Oscillation range shall be decreased.

In regard to dealing with the input pin, it is recommendable to put the input pin into the GND at first, and the other side of signal input pin, to be connected into GND with the resistor of less than about  $10\text{k}\Omega$  on DC condition.

• The Application Purpose and Recommended Value of the External Parts.

EXTERNAL PARTS	APPLICATION PURPOSE	RECOMMENDED VALUE	REMARKS
R <sub>S</sub>	Current like noise reduction V <sub>OQ</sub> stabilization	Below 10kΩ	The noise becomes high when the input pin open.
C <sub>IN</sub>	V <sub>OQ</sub> stabilization	1μF	It is not required in case when there is no DC offset in the input signal.
C <sub>P1</sub>	V <sup>+</sup> stabilization	≒ C <sub>cup</sub> .	It can be decreased in value when the output impedance source is low.
C <sub>P2</sub>	Oscillation prevention	0.1μF	Insert near around the supply source and GND pins.
C <sub>V</sub>	Ripple rejection to V <sub>O</sub> by way of V <sup>+</sup>	47μF	It is not required when the V <sup>+</sup> is stabilized.
*C <sub>O</sub>	Oscillation prevention	0.047μF	To be decided in value according to load condition.
*R <sub>O</sub>	Oscillation prevention	10Ω	To be decided in value according to load condition.
C <sub>CUP</sub>	Output DC decoupling	470μF when R <sub>L</sub> = 4Ω 220μF when R <sub>L</sub> = 8Ω	Low band cutoff frequency (f <sub>L</sub> ) shall be decided by C <sub>CUP</sub> R <sub>L</sub> . When C <sub>CUP</sub> is less in value, f <sub>L</sub> is to be increased.

NJM386B Recommended Circuit

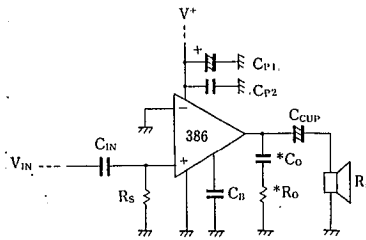

## ■ TYPICAL CHARACTERISTICS

### Operating Current vs. Temperature

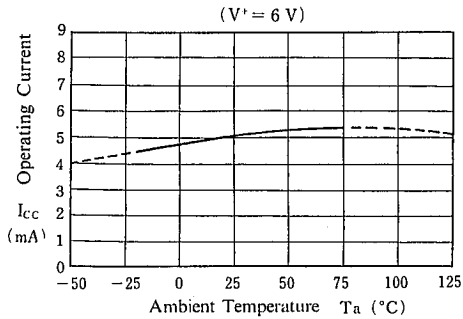

### Voltage Gain vs. Temperature

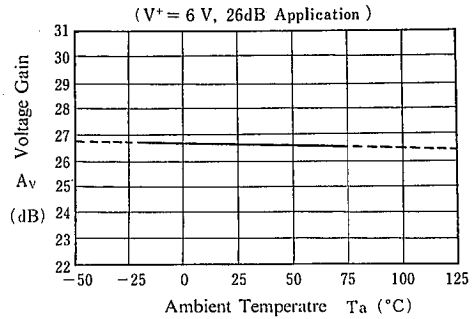

### Operating Current vs. Operating Voltage

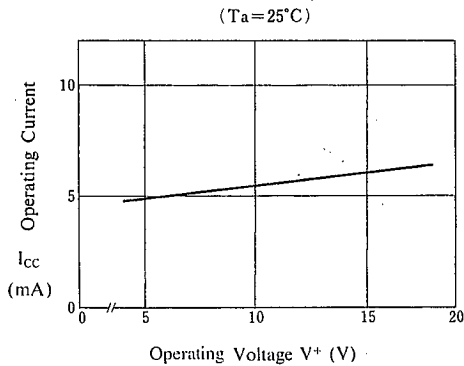

### Maximum Output Voltage Swing vs. Operating Voltage

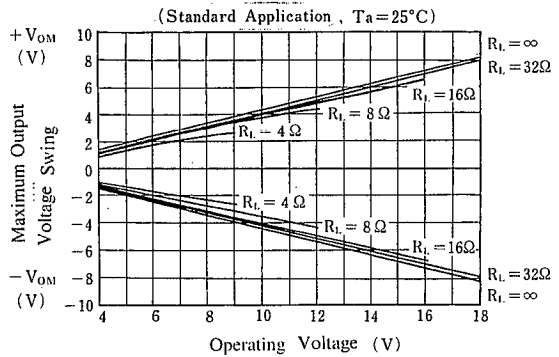

### Total Harmonic Distortion vs. Output Power

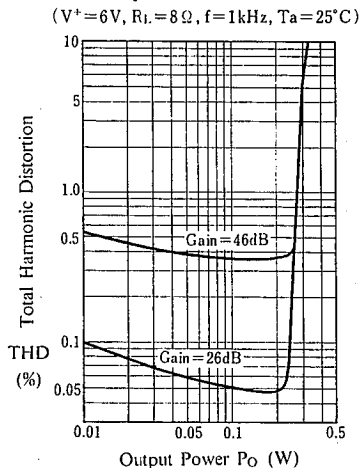

■ TYPICAL CHARACTERISTICS

Power Dissipation vs. Output Power  
( $R_L=4\ \Omega$ ,  $T_a=25^\circ\text{C}$ )

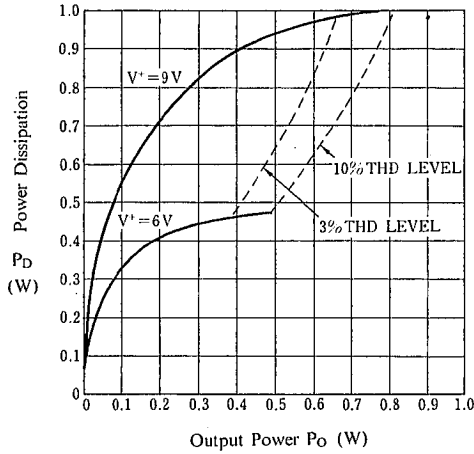

Power Dissipation vs. Output Power  
( $R_L=8\ \Omega$ ,  $T_a=25^\circ\text{C}$ )

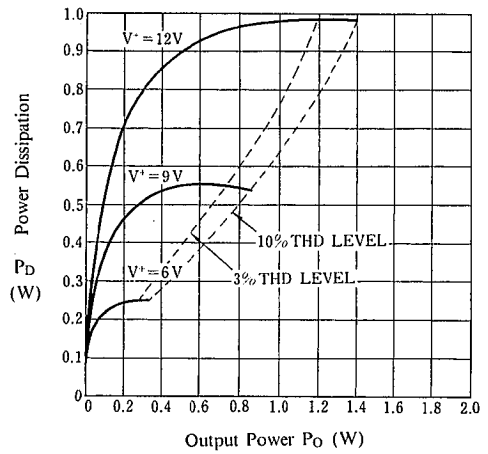

Power Dissipation vs. Output Power  
( $R_L=16\ \Omega$ ,  $T_a=25^\circ\text{C}$ )

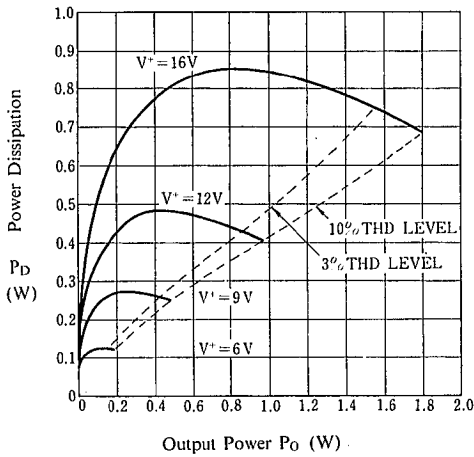

Power Dissipation vs. Output Power  
( $R_L=32\ \Omega$ ,  $T_a=25^\circ\text{C}$ )

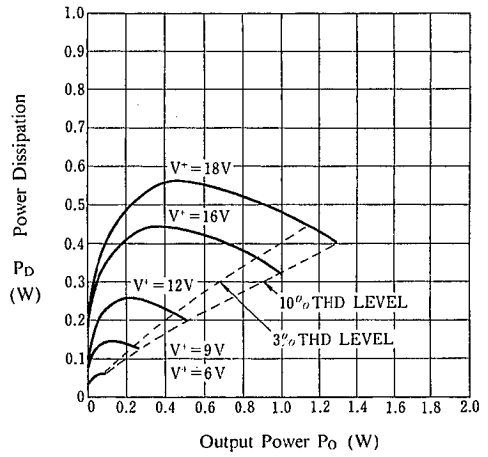

5

## MEMO

[CAUTION]

The specifications on this databook are only given for information, without any guarantee as regards either mistakes or omissions. The application circuits in this databook are described only to show representative usages of the product and not intended for the guarantee or permission of any right including the industrial rights.