



Chipsmall Limited consists of a professional team with an average of over 10 year of expertise in the distribution of electronic components. Based in Hongkong, we have already established firm and mutual-benefit business relationships with customers from,Europe,America and south Asia,supplying obsolete and hard-to-find components to meet their specific needs.

With the principle of “Quality Parts,Customers Priority,Honest Operation,and Considerate Service”,our business mainly focus on the distribution of electronic components. Line cards we deal with include Microchip,ALPS,ROHM,Xilinx,Pulse,ON,Everlight and Freescale. Main products comprise IC,Modules,Potentiometer,IC Socket,Relay,Connector.Our parts cover such applications as commercial,industrial, and automotives areas.

We are looking forward to setting up business relationship with you and hope to provide you with the best service and solution. Let us make a better world for our industry!



## Contact us

Tel: +86-755-8981 8866 Fax: +86-755-8427 6832

Email & Skype: info@chipsmall.com Web: www.chipsmall.com

Address: A1208, Overseas Decoration Building, #122 Zhenhua RD., Futian, Shenzhen, China



## PLL Synthesizer with I<sup>2</sup>C Bus for TV Tuner

### DESCRIPTION

The NJW1504/1508 are a PLL frequency synthesizer especially designed for TV and VCR tuning systems and consists of PLL circuit and a prescaler which operates up to 1.0GHz, built into one chip.

The NJW1504/1508 are controlled through an I<sup>2</sup>C-bus.

### FEATURES

- Operating Voltage 5V
- Low Operating Current : 15mA typ. @V<sub>cc</sub>=5V
- Prescaler accepts frequencies up to 1GHz on chip
- Reference Signal :  
 NJW1504: Reference Signal Oscillator with peripheral of Xtal on chip  
 NJW1508: Buffer Amplifier for External Reference Signal on chip
- 34V max. tuning voltage output
- Package Outline: SSOP16

### PACKAGE OUTLINE

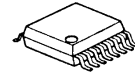

NJW1504V/NJW1508V

### BLOCK DIAGRAM

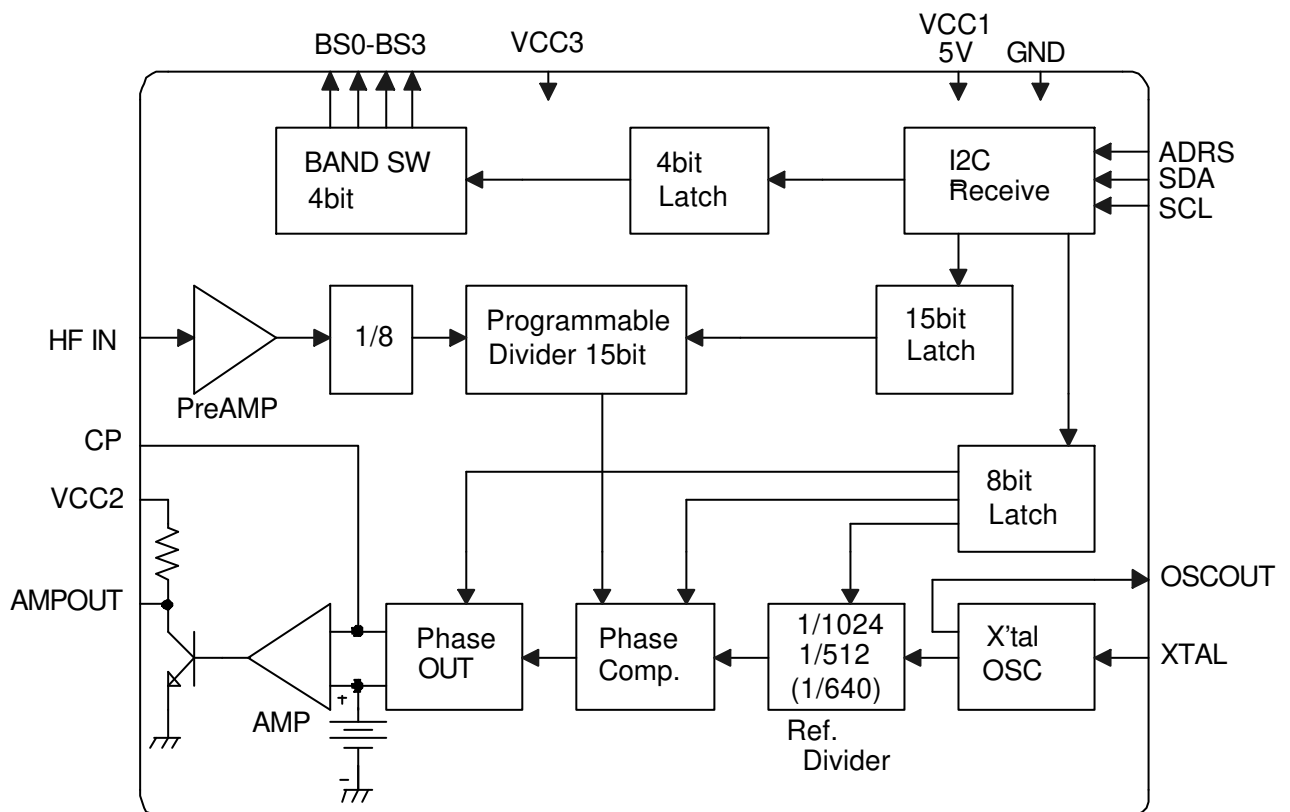

(Note)

Purchase of I<sup>2</sup>C components of New Japan Radio Co., Ltd or one of its sublicensed Associated Companies conveys a license under the Philips I<sup>2</sup>C Patent Rights to use these components in an I<sup>2</sup>C system, provided that the system conforms to the I<sup>2</sup>C standard specification as defined by Philips.

# NJW1504/1508

## ■ ABSOLUTE MAXIMUM RATINGS

(T<sub>A</sub>=25°C)

Parameter	Symbol	Ratings	Unit
Supply Voltage (Vcc1, 3)	Vcc1, Vcc3	-0.3 to +6.5	V
Supply Voltage (Vcc2)	Vcc2	-0.3 to +36	V
Input Voltage (except I <sup>2</sup> C bus)	V <sub>i</sub>	-0.3 to Vcc+0.3	V
Output Voltage (except I <sup>2</sup> C bus)	V <sub>o</sub>	-0.3 to Vcc+0.3	V
I <sup>2</sup> C bus Input Voltage	V <sub>iiic</sub>	-0.3 to 6.5	V
Power Dissipation	P <sub>D</sub>	300	mW
Operating Temperature Range	T <sub>opr</sub>	-20 to +85	°C
Storage Temperature Range	T <sub>stg</sub>	-40 to +125	°C

## ■ RECOMMENDED OPERATING CONDITION

(T<sub>A</sub>=25°C)

Parameter	Condition	Symbol	Min.	Typ.	Max.	Unit
Operating Voltage	Vcc1, Vcc3	Vcc1, Vcc3	4.5	5	5.5	V
Operating Voltage	Vcc2	Vcc2	0	-	34	V
X'tal Operating Range		f <sub>xial</sub>	3.15	4	4.05	MHz
HF Input Frequency	Input= -20dBm	f <sub>hf</sub>	80	-	1000	MHz
Clock Frequency		f <sub>SCL</sub>	0	-	100	KHz
Bus Free Time		t <sub>BUF</sub>	4.7	-	-	uS
Data Hold Time		t <sub>HDSTA</sub>	2	-	-	uS
SCL Low Hold Time		t <sub>LOW</sub>	4.7	-	-	uS
SCL High Hold Time		t <sub>HIGH</sub>	2	-	-	uS
Set-up Time	Refer to I <sup>2</sup> C bus Timing Chart	t <sub>SUSTA</sub>	2	-	-	uS
Data Hold Time		t <sub>HDDAT</sub>	0	-	-	uS
Data Set-up Time		t <sub>SUDAT</sub>	250	-	-	nS
Rise Time		t <sub>R</sub>	-	-	1000	nS
Fall Time		t <sub>F</sub>	-	-	300	nS
Data Set-up Time		t <sub>SUSTO</sub>	4	-	-	uS

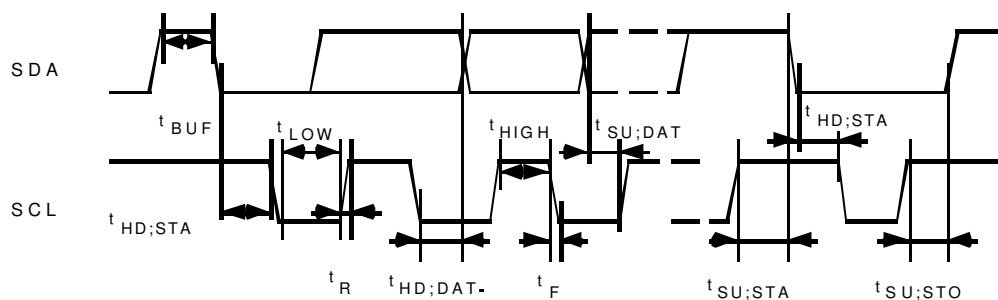

I<sup>2</sup>C bus Timing Chart

V<sub>IH</sub>min(0.7 Vcc1) and V<sub>IL</sub>max(0.3 Vcc1)

## ■ ELECTRICAL CHARACTERISTICS

(V<sub>CC1,3</sub>=5V, V<sub>CC2</sub>=34V, T<sub>A</sub>=25°C)

Parameter	Condition	Symbol	Min.	Typ.	Max.	Unit
Operating Current 1	f <sub>HF</sub> =100MHz	I <sub>CC</sub>	12	15	21	mA
Operating Current 2	AMPOUT: Low Level	I <sub>CC2</sub>	-	1.6	-	mA
AMP Input Current	Phase OUT: High Imp (2.5V)	I <sub>IN</sub>	(-50)	0.1	(50)	nA
AMP Output Current	ANP OUT: Low Level AMPOUT Input=5V	I <sub>OUT</sub>	-	-	-2	mA
AMP Gain	f=1KHz	AV	40	50	60	dB
Phase Comparator Output Current	Current Source	I <sub>source</sub>	190	280	400	uA
Phase Comparator Output Current	Current Sink	I <sub>sink</sub>	-400	-280	-190	uA
Band Switch						
"L" Output Current	BS0=BS1=0.3V	I <sub>OBS0-1L</sub>	-2.0	-1	0	mA
"H" Output Current	BS0=BS1=4.7V	I <sub>OBS0-1H</sub>	11.0	15.0	-	mA
"L" Output Current	BS2=BS3=0.3V	I <sub>OBS2-3L</sub>	-2.0	-1.0	0	mA
"H" Output Current	BS2=BS3=4.7V	I <sub>OBS2-3H</sub>	5.5	7.5	-	mA
I <sup>2</sup> C bus						
"H" Input Current	SCL, SDA Terminal	I <sub>INH</sub>	-5	0	5	uA
"L" Input Current	SCL, SDA Terminal	I <sub>INL</sub>	-5	0	5	uA
"H" Input Voltage Range	SCL, SDA Terminal	V <sub>IH</sub>	3.5	-	5.3	V
"L" Input Voltage Range	SCL, SDA Terminal	V <sub>IL</sub>	0	-	1.5	V
ACK Sink Current	ACK Output, SDA=0.4V	V <sub>ACK</sub>	3	-	-	mA

# NJW1504/1508

## ■ TEST CIRCUIT

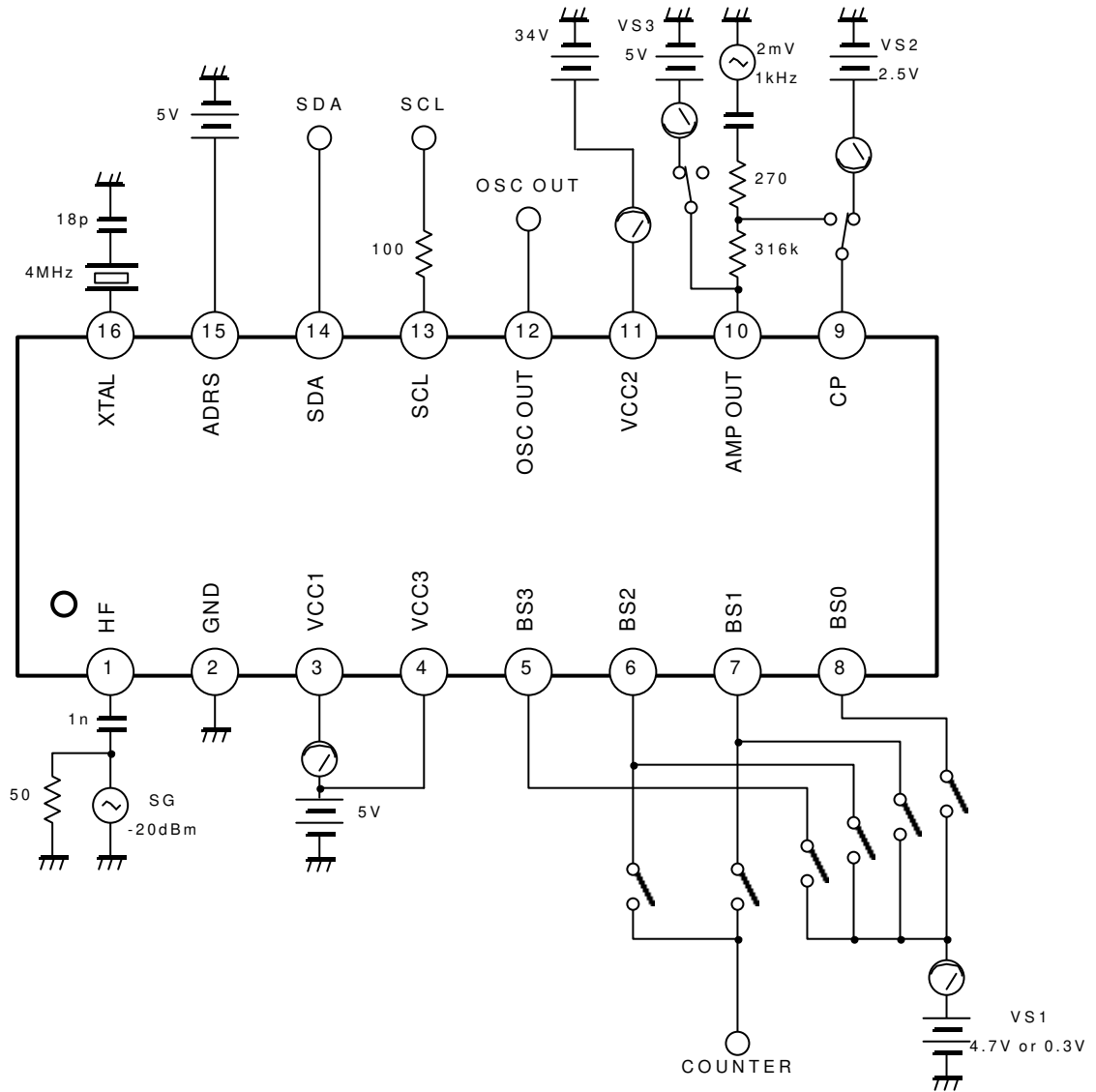

## ■ I<sup>2</sup>C bus Protocols

The input information, which consists of chip address and next two or four byte data, is received by I<sup>2</sup>C bus receiver. The allowable I<sup>2</sup>C bus protocols are as follows.

- (1) STA CA CB BB STO
- (2) STA CA D1 D2 STO
- (3) STA CA CB BB D1 D2 STO
- (4) STA CA D1 D2 CB BB STO

STA: Start Condition

STO: Stop Condition

CA: Chip Address

CB: Control Byte

BB: Band switch Byte

D1: Divider Byte 1

D2: Divider Byte 2

For suitable circuit operation, 5-byte data should have chip address, 2-byte control data, band data, and 2-byte divider byte. Following chip address, 2-byte data is received. For distinction of each data, first and third data byte has a function bit. As function bit, divider byte has "1" and control/band data has "0".

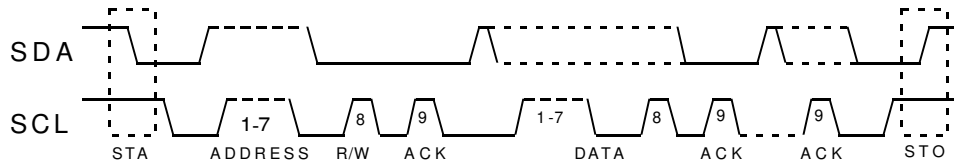

# NJW1504/1508

## ■ Data Format

Parameter	Symbol	MSB								LSB
Chip Address	CA	1	1	0	0	0	CA1	CA0	0	A
Divider Byte 1	D1	0	N14	N13	N12	N11	N10	N9	N8	A
Divider Byte 2	D2	N7	N6	N5	N4	N3	N2	N1	N0	A
Control Byte	CB	1	CP	T2	T1	T0	RD1	RD0	×	A
Band switch Byte	BB	×	×	×	×	BS3	BS2	BS1	BS0	A

### · Data specifications

× : don't care ;0 or 1

CA1, CA0 : Programmable address bits

ADRS Voltage	CA1	CA0
Always valid	0	1
0 to 0.1 Vcc1	0	0
0.4 Vcc1 to 0.6 Vcc1	1	0
0.9 Vcc1 to Vcc1	1	1

BS0 to BS3 : Band switch buffers Control bits, BS<sub>n</sub>=1 then "ON"

N0 to N14 : Control of Programmable divider bits, N14=MSB N0=LSB

Dividing ratio :  $N=2^{14} \times N14 + 2^{13} \times N13 + \dots + 2^1 \times N1 + N0$

Maximum division ratio 32767

Minimum division ratio 256

CP : Charge Pump Current

CP	Charge Pump Current	Conditions
1	280μA	Normal, Default
0	60μA	Test

T0 to T2 :Test mode bits

T0,T1,T2 :Phase Comparator Output bits

T2	T1	T0	Phase Comparator, Band Switch	Conditions
0	0	×	Normal Output	Normal, Default
1	0	1	Phase Comparator (High Impedance)	Test
1	1	0	Phase Comparator (Sink)	Test
1	1	1	Phase Comparator (Source)	Test

RD1, RD0 : Reference Divider bits

RD1	RD2	Reference Divider	Conditions
×	0	640	
1	1	512	Default
0	1	1024	

(Note)

Default : Power on reset

## ■ TERMINAL CHARACTERISTICS

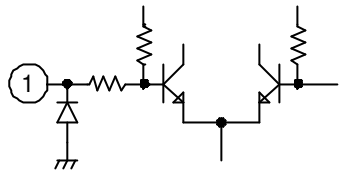
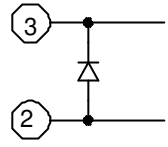
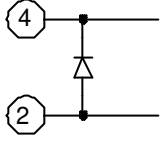
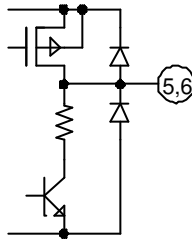
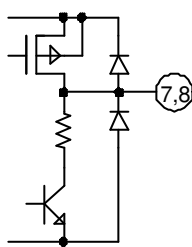
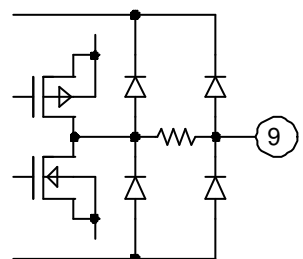
No.	Symbol	Typ.DC Voltage (V)	Equivalent Circuit	Function
1	HF	3.2		High Frequency Signal Input
2	GND	0		GND
3	VCC1	5		Power Supply
4	VCC3	5		Band Switch Power Supply
5 6	BS3 BS2	0		Band Switch (Typ: 7.5mA)
7 8	BS1 BS0	0		Band Switch (Typ: 15mA)
9	CP	-		Charge Pump Output



No.	Symbol	Typ.DC Voltage (V)	Equivalent Circuit	Function
10	AMPOUT	-		Amplifier Output
11	VCC2	34		Amplifier Power Supply
12	OSCOUT	4.1		Reference Oscillator Output
13	SCL	-		SCL Input (I <sup>2</sup> C bus)
14	SDA	-		SCL Input (I <sup>2</sup> C bus)
15	ADRS	-		ADRS Input (I <sup>2</sup> C bus)
16	XTAL	3.3		Crystal Input

## ■ TYPICAL CHARACTERISTICS

$T_A=25^\circ\text{C}$

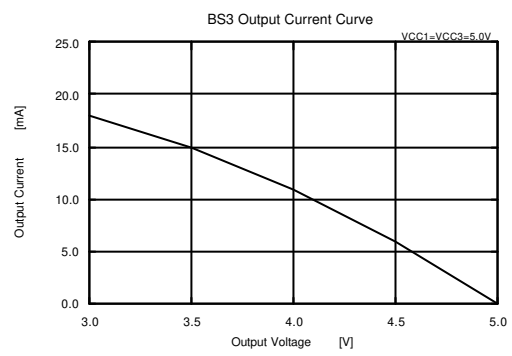
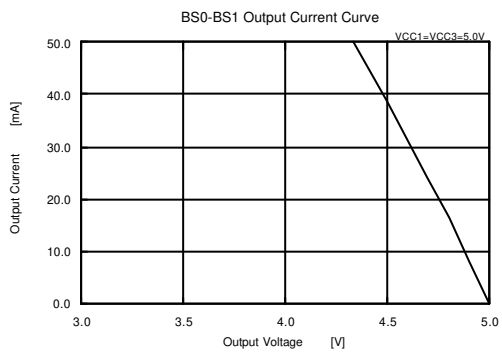
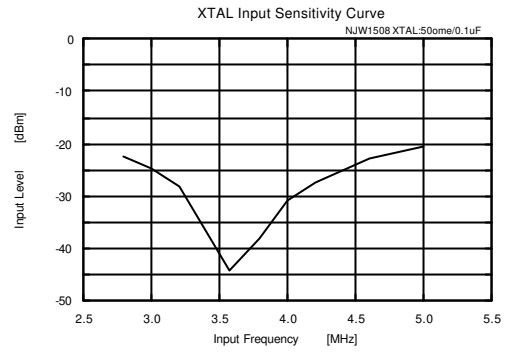
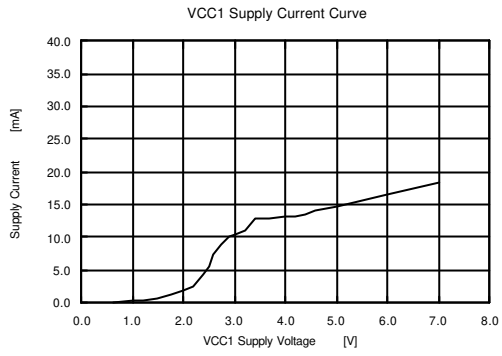

---

# MEMO

**[CAUTION]**

The specifications on this databook are only given for information, without any guarantee as regards either mistakes or omissions. The application circuits in this databook are described only to show representative usages of the product and not intended for the guarantee or permission of any right including the industrial rights.