



Chipsmall Limited consists of a professional team with an average of over 10 year of expertise in the distribution of electronic components. Based in Hongkong, we have already established firm and mutual-benefit business relationships with customers from,Europe,America and south Asia,supplying obsolete and hard-to-find components to meet their specific needs.

With the principle of “Quality Parts,Customers Priority,Honest Operation,and Considerate Service”,our business mainly focus on the distribution of electronic components. Line cards we deal with include Microchip,ALPS,ROHM,Xilinx,Pulse,ON,Everlight and Freescale. Main products comprise IC,Modules,Potentiometer,IC Socket,Relay,Connector.Our parts cover such applications as commercial,industrial, and automotives areas.

We are looking forward to setting up business relationship with you and hope to provide you with the best service and solution. Let us make a better world for our industry!



## Contact us

Tel: +86-755-8981 8866 Fax: +86-755-8427 6832

Email & Skype: info@chipsmall.com Web: www.chipsmall.com

Address: A1208, Overseas Decoration Building, #122 Zhenhua RD., Futian, Shenzhen, China



# NLAS4053

## Analog Multiplexer/ Demultiplexer

### Triple 2:1 Analog Switch–Multiplexer Improved Process, Sub–Micron Silicon Gate CMOS

The NLAS4053 is an improved version of the MC14053 and MC74HC4053 fabricated in sub–micron Silicon Gate CMOS technology for lower  $R_{DS(on)}$  resistance and improved linearity with low current. This device may be operated either with a single supply or dual supply up to  $\pm 3.0$  V to pass a 6  $V_{PP}$  signal without coupling capacitors.

When operating in single supply mode, it is only necessary to tie  $V_{EE}$ , pin 7 to ground. For dual supply operation,  $V_{EE}$  is tied to a negative voltage, not to exceed maximum ratings. Pin for pin compatible with all industry standard versions of '4053.'

#### Features

- Improved  $R_{DS(on)}$  Specifications
- Pin for Pin Replacement for MAX4053 and MAX4053A
  - One Half the Resistance Operating at 5.0 Volts
- Single or Dual Supply Operation
  - Single 3–5 Volt Operation, or Dual  $\pm 3.0$  Volt Operation
  - With  $V_{CC}$  of 3.0 to 3.3 V, Device Can Interface with 1.8 V Logic, No Translators Needed
  - Address and Inhibit Pins are Over–Voltage Tolerant and May Be Driven Up +6.0 V Regardless of  $V_{CC}$
  - Greatly Improved Noise Margin Over MAX4053 and MAX4053A
- Improved Linearity Over Standard HC4053 Devices
- Popular SOIC and the Space Saving TSSOP Packages
- Pb–Free Packages are Available\*



ON Semiconductor®

<http://onsemi.com>

#### MARKING DIAGRAMS

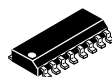

SOIC–16  
D SUFFIX  
CASE 751B

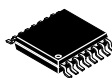
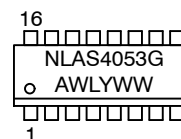

TSSOP–16  
DT SUFFIX  
CASE 948F

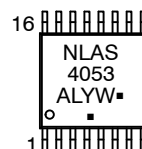

A = Assembly Location  
L, WL = Wafer Lot  
Y = Year  
W, WW = Work Week  
G = Pb–Free Package  
▪ = Pb–Free Package  
(Note: Microdot may be in either location)

#### ORDERING INFORMATION

See detailed ordering and shipping information in the package dimensions section on page 4 of this data sheet.

\*For additional information on our Pb–Free strategy and soldering details, please download the ON Semiconductor Soldering and Mounting Techniques Reference Manual, SOLDERRM/D.

# NLAS4053



**Figure 1. Pin Connection**  
(Top View)

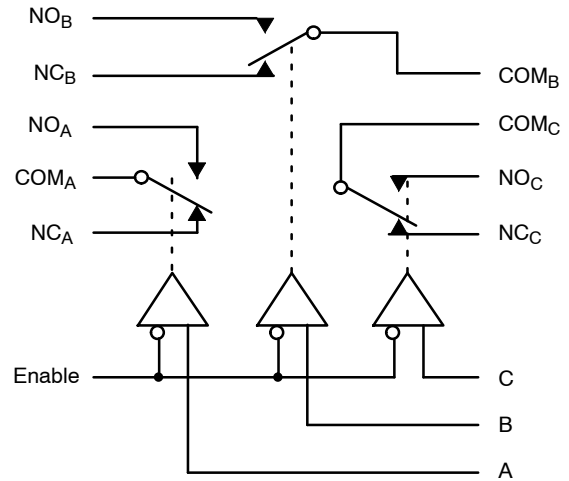

**Figure 2. Logic Diagram**

## TRUTH TABLE

| Inhibit | Address         |                 |                 | ON SWITCHES*  |
|---------|-----------------|-----------------|-----------------|---|
|         | C               | B               | A               |   |
| 1       | X<br>don't care | X<br>don't care | X<br>don't care | All switches open   |
| 0       | 0               | 0               | 0               | COM <sub>A</sub> -NC <sub>A</sub> ,<br>COM <sub>B</sub> -NC <sub>B</sub> ,<br>COM <sub>C</sub> -NC <sub>C</sub> |
| 0       | 0               | 0               | 1               | COM <sub>A</sub> -NO <sub>A</sub> ,<br>COM <sub>B</sub> -NC <sub>B</sub> ,<br>COM <sub>C</sub> -NC <sub>C</sub> |
| 0       | 0               | 1               | 0               | COM <sub>A</sub> -NC <sub>A</sub> ,<br>COM <sub>B</sub> -NO <sub>B</sub> ,<br>COM <sub>C</sub> -NC <sub>C</sub> |
| 0       | 0               | 1               | 1               | COM <sub>A</sub> -NO <sub>A</sub> ,<br>COM <sub>B</sub> -NO <sub>B</sub> ,<br>COM <sub>C</sub> -NC <sub>C</sub> |
| 0       | 1               | 0               | 0               | COM <sub>A</sub> -NC <sub>A</sub> ,<br>COM <sub>B</sub> -NC <sub>B</sub> ,<br>COM <sub>C</sub> -NO <sub>C</sub> |
| 0       | 1               | 0               | 1               | COM <sub>A</sub> -NO <sub>A</sub> ,<br>COM <sub>B</sub> -NC <sub>B</sub> ,<br>COM <sub>C</sub> -NO <sub>C</sub> |
| 0       | 1               | 1               | 0               | COM <sub>A</sub> -NC <sub>A</sub> ,<br>COM <sub>B</sub> -NO <sub>B</sub> ,<br>COM <sub>C</sub> -NO <sub>C</sub> |
| 0       | 1               | 1               | 1               | COM <sub>A</sub> -NO <sub>A</sub> ,<br>COM <sub>B</sub> -NO <sub>B</sub> ,<br>COM <sub>C</sub> -NO <sub>C</sub> |

\*NO, NC, and COM pins are identical and interchangeable. Either may be considered an input or output; signals pass equally well in either direction.

# NLAS4053

## MAXIMUM RATINGS

| Symbol               | Parameter   | Value  | Unit |
|----------------------|---|--|------|
| V <sub>EE</sub>      | Negative DC Supply Voltage<br>(Referenced to GND)   | -7.0 to +0.5                                 | V    |
| V <sub>CC</sub>      | Positive DC Supply Voltage (Note 1)<br>(Referenced to GND)<br>(Referenced to V <sub>EE</sub> )                | -0.5 to +7.0<br>-0.5 to +7.0                 | V    |
| V <sub>IS</sub>      | Analog Input Voltage  | V <sub>EE</sub> -0.5 to V <sub>CC</sub> +0.5 | V    |
| V <sub>IN</sub>      | Digital Input Voltage<br>(Referenced to GND)  | -0.5 to 7.0                                  | V    |
| I                    | DC Current, Into or Out of Any Pin  | ± 50   | mA   |
| T <sub>STG</sub>     | Storage Temperature Range   | -65 to +150                                  | °C   |
| T <sub>L</sub>       | Lead Temperature, 1 mm from Case for 10 Seconds   | 260  | °C   |
| T <sub>J</sub>       | Junction Temperature under Bias   | +150   | °C   |
| θ <sub>JA</sub>      | Thermal Resistance<br>SOIC<br>TSSOP   | 143<br>164                                   | °C/W |
| P <sub>D</sub>       | Power Dissipation in Still Air,<br>SOIC<br>TSSOP  | 500<br>450                                   | mW   |
| MSL                  | Moisture Sensitivity  | Level 1                                      |      |
| F <sub>R</sub>       | Flammability Rating<br>Oxygen Index: 30% - 35%  | UL 94 V-0 @ 0.125 in                         |      |
| V <sub>ESD</sub>     | ESD Withstand Voltage<br>Human Body Model (Note 2)<br>Machine Model (Note 3)<br>Charged Device Model (Note 4) | > 2000<br>> 200<br>> 1000                    | V    |
| I <sub>LATCHUP</sub> | Latchup Performance<br>Above V <sub>CC</sub> and Below GND at 125°C (Note 5)                                  | ± 300  | mA   |

Stresses exceeding Maximum Ratings may damage the device. Maximum Ratings are stress ratings only. Functional operation above the Recommended Operating Conditions is not implied. Extended exposure to stresses above the Recommended Operating Conditions may affect device reliability.

1. The absolute value of V<sub>CC</sub> ± |V<sub>EE</sub>| ≤ 7.0.
2. Tested to EIA/JESD22-A114-A.
3. Tested to EIA/JESD22-A115-A.
4. Tested to JESD22-C101-A.
5. Tested to EIA/JESD78.

## RECOMMENDED OPERATING CONDITIONS

| Symbol                          | Parameter   | Min             | Max             | Unit |
|---------------------------------|---|-----------------|-----------------|------|
| V <sub>EE</sub>                 | Negative DC Supply Voltage<br>(Referenced to GND)   | -5.5            | GND             | V    |
| V <sub>CC</sub>                 | Positive DC Supply Voltage<br>(Referenced to GND)<br>(Referenced to V <sub>EE</sub> )   | 2.5<br>2.5      | 5.5<br>6.6      | V    |
| V <sub>IS</sub>                 | Analog Input Voltage  | V <sub>EE</sub> | V <sub>CC</sub> | V    |
| V <sub>IN</sub>                 | Digital Input Voltage<br>(Note 6) (Referenced to GND)   | 0               | 5.5             | V    |
| T <sub>A</sub>                  | Operating Temperature Range, All Package Types  | -55             | 125             | °C   |
| t <sub>r</sub> , t <sub>f</sub> | Input Rise/Fall Time<br>(Channel Select or Enable Inputs)<br>V <sub>CC</sub> = 3.0 V ± 0.3 V<br>V <sub>CC</sub> = 5.0 V ± 0.5 V | 0<br>0          | 100<br>20       | ns/V |

6. Unused digital inputs may not be left open. All digital inputs must be tied to a high-logic voltage level or a low-logic input voltage level.

# NLAS4053

## ORDERING INFORMATION

| Device        | Package              | Shipping†        |
|---------------|----------------------|------------------|
| NLAS4053DG    | SOIC-16<br>(Pb-Free) | 48 Units / Rail  |
| NLAS4053DR2   | SOIC-16              | 2500 Tape & Reel |
| NLAS4053DR2G  | SOIC-16<br>(Pb-Free) | 2500 Tape & Reel |
| NLAS4053DT    | TSSOP-16*            | 96 Units / Rail  |
| NLAS4053DTG   | TSSOP-16*            | 96 Units / Rail  |
| NLAS4053DTR2  | TSSOP-16*            | 2500 Tape & Reel |
| NLAS4053DTR2G | TSSOP-16*            | 2500 Tape & Reel |

†For information on tape and reel specifications, including part orientation and tape sizes, please refer to our Tape and Reel Packaging Specifications Brochure, BRD8011/D.

\*This package is inherently Pb-Free.

## DC CHARACTERISTICS – Digital Section (Voltages Referenced to GND)

| Symbol          | Parameter  | Condition   | V <sub>CC</sub><br>V | Guaranteed Limit |        |         | Unit |
|-----------------|--|---|----------------------|------------------|--------|---------|------|
|                 |  |   |                      | -55 to 25°C      | ≤ 85°C | ≤ 125°C |      |
| V <sub>IH</sub> | Minimum High-Level Input Voltage, Address and Inhibit Inputs |   | 2.0                  | 1.5              | 1.5    | 1.5     | V    |
|                 |  |   | 3.0                  | 2.1              | 2.1    | 2.1     |      |
|                 |  |   | 4.5                  | 3.15             | 3.15   | 3.15    |      |
|                 |  |   | 5.5                  | 3.85             | 3.85   | 3.85    |      |
| V <sub>IL</sub> | Maximum Low-Level Input Voltage, Address and Inhibit Inputs  |   | 2.0                  | 0.5              | 0.5    | 0.5     | V    |
|                 |  |   | 3.0                  | 0.9              | 0.9    | 0.9     |      |
|                 |  |   | 4.5                  | 1.35             | 1.35   | 1.35    |      |
|                 |  |   | 5.5                  | 1.65             | 1.65   | 1.65    |      |
| I <sub>IN</sub> | Maximum Input Leakage Current, Address or Inhibit Inputs     | V <sub>IN</sub> = 6.0 or GND  | 0 V to 6.0 V         | ± 0.1            | ± 1.0  | ± 1.0   | µA   |
| I <sub>CC</sub> | Maximum Quiescent Supply Current (per Package)               | Channel Select, Enable and V <sub>IS</sub> = V <sub>CC</sub> or GND | 6.0                  | 4.0              | 40     | 80      | µA   |

## DC ELECTRICAL CHARACTERISTICS – Analog Section

| Symbol                                       | Parameter  | Test Conditions  | V <sub>CC</sub><br>V | V <sub>EE</sub><br>V | Guaranteed Limit |        |         | Unit |
|--|--|--|----------------------|----------------------|------------------|--------|---------|------|
|  |  |  |                      |                      | -55 to 25°C      | ≤ 85°C | ≤ 125°C |      |
| R <sub>ON</sub>                              | Maximum "ON" Resistance  | V <sub>IN</sub> = V <sub>IL</sub> or V <sub>IH</sub><br>V <sub>IS</sub> = V <sub>EE</sub> to V <sub>CC</sub><br> I <sub>S</sub>   = 10 mA<br>(Figures 4 thru 9)    | 3.0                  | 0                    | 86               | 108    | 120     | Ω    |
|  |  |  | 4.5                  | 0                    | 37               | 46     | 55      |      |
|  |  |  | 3.0                  | -3.0                 | 26               | 33     | 37      |      |
| ΔR <sub>ON</sub>                             | Maximum Difference in "ON" Resistance Between Any Two Channels in the Same Package | V <sub>IN</sub> = V <sub>IL</sub> or V <sub>IH</sub> , V <sub>IS</sub> = 2.0 V<br>V <sub>IS</sub> = 3.5 V<br>V <sub>IS</sub> = 2.0 V<br> I <sub>S</sub>   = 10 mA, | 3.0                  | 0                    | 15               | 20     | 20      | Ω    |
|  |  |  | 4.5                  | 0                    | 13               | 18     | 18      |      |
|  |  |  | 3.0                  | -3.0                 | 10               | 15     | 15      |      |
| R <sub>flat(ON)</sub>                        | COM-NO On-Resistance Flatness  | V <sub>com</sub> 1, 2, 3.5 V<br>V <sub>com</sub> -2, 0, 2 V<br> I <sub>S</sub>   = 10 mA   | 4.5                  | 0                    | 4                | 4      | 5       | Ω    |
|  |  |  | 3.0                  | -3.0                 | 2                | 2      | 3       |      |
| I <sub>NC(OFF)</sub><br>I <sub>NO(OFF)</sub> | Maximum Off-Channel Leakage Current  | Switch Off<br>V <sub>IN</sub> = V <sub>IL</sub> or V <sub>IH</sub><br>V <sub>IO</sub> = V <sub>CC</sub> -1.0 V or V <sub>EE</sub> +1.0 V<br>(Figure 17)            | 6.0                  | 0                    | 0.1              | 5.0    | 100     | nA   |
|  |  |  | 3.0                  | -3.0                 | 0.1              | 5.0    | 100     |      |
| I <sub>COM(ON)</sub>                         | Maximum On-Channel Leakage Current, Channel- to-Channel                            | Switch On<br>V <sub>IO</sub> = V <sub>CC</sub> -1.0 V or V <sub>EE</sub> +1.0 V<br>(Figure 17)   | 6.0                  | 0                    | 0.1              | 5.0    | 100     | nA   |
|  |  |  | 3.0                  | -3.0                 | 0.1              | 5.0    | 100     |      |

# NLAS4053

## AC CHARACTERISTICS (Input $t_r = t_f = 3$ ns)

| Symbol           | Parameter                      | Test Conditions  | V <sub>CC</sub><br>V | V <sub>EE</sub><br>V | Guaranteed Limit |      |        |         | Unit |
|------------------|--------------------------------|--|----------------------|----------------------|------------------|------|--------|---------|------|
|                  |                                |  |                      |                      | -55 to 25°C      |      | ≤ 85°C | ≤ 125°C |      |
|                  |                                |  |                      |                      | Min              | Typ* |        |         |      |
| t <sub>BBM</sub> | Minimum Break-Before-Make Time | V <sub>IN</sub> = V <sub>IL</sub> or V <sub>IH</sub><br>V <sub>IS</sub> = V <sub>CC</sub><br>R <sub>L</sub> = 300 Ω, C <sub>L</sub> = 35 pF<br>(Figure 19) | 3.0                  | 0.0                  | 1.0              | 6.5  | -      | -       | ns   |
|                  |                                |  | 4.5                  | 0.0                  | 1.0              | 5.0  | -      | -       |      |
|                  |                                |  | 3.0                  | -3.0                 | 1.0              | 3.5  | -      | -       |      |

\*Typical Characteristics are at 25°C.

## AC CHARACTERISTICS (C<sub>L</sub> = 50 pF, Input $t_r = t_f = 3$ ns)

| Symbol             | Parameter   | V <sub>CC</sub><br>V | V <sub>EE</sub><br>V | Guaranteed Limit |     |     |        |     |         | Unit |     |
|--------------------|---|----------------------|----------------------|------------------|-----|-----|--------|-----|---------|------|-----|
|                    |   |                      |                      | -55 to 25°C      |     |     | ≤ 85°C |     | ≤ 125°C |      |     |
|                    |   |                      |                      | Min              | Typ | Max | Min    | Max | Min     |      | Max |
| t <sub>TRANS</sub> | Transition Time<br>(Address Selection Time)<br>(Figure 18)                                  | 2.5                  | 0                    |                  |     | 40  |        | 45  |         | 50   | ns  |
|                    |   | 3.0                  | 0                    |                  |     | 28  |        | 30  |         | 35   |     |
|                    |   | 4.5                  | 0                    |                  |     | 23  |        | 25  |         | 30   |     |
|                    |   | 3.0                  | -3.0                 |                  |     | 23  |        | 25  |         | 28   |     |
| t <sub>ON</sub>    | Turn-on Time<br>(Figures 14, 15, 20, and 21)<br>Enable to N <sub>O</sub> or N <sub>C</sub>  | 2.5                  | 0                    |                  |     | 40  |        | 45  |         | 50   | ns  |
|                    |   | 3.0                  | 0                    |                  |     | 28  |        | 30  |         | 35   |     |
|                    |   | 4.5                  | 0                    |                  |     | 23  |        | 25  |         | 30   |     |
|                    |   | 3.0                  | -3.0                 |                  |     | 23  |        | 25  |         | 28   |     |
| t <sub>OFF</sub>   | Turn-off Time<br>(Figures 14, 15, 20, and 21)<br>Enable to N <sub>O</sub> or N <sub>C</sub> | 2.5                  | 0                    |                  |     | 40  |        | 45  |         | 50   | ns  |
|                    |   | 3.0                  | 0                    |                  |     | 28  |        | 30  |         | 35   |     |
|                    |   | 4.5                  | 0                    |                  |     | 23  |        | 25  |         | 30   |     |
|                    |   | 3.0                  | -3.0                 |                  |     | 23  |        | 25  |         | 28   |     |

|                                    |  | Typical @ 25°C, V <sub>CC</sub> = 5.0 V |  | pF |
|------------------------------------|--|---|--|----|
| C <sub>IN</sub>                    | Maximum Input Capacitance, Select Inputs | 8                                       |  |    |
| C <sub>NO</sub> or C <sub>NC</sub> | Analog I/O                               | 10                                      |  |    |
| C <sub>COM</sub>                   | Common I/O                               | 10                                      |  |    |
| C <sub>(ON)</sub>                  | Feedthrough                              | 1.0                                     |  |    |

## ADDITIONAL APPLICATION CHARACTERISTICS (GND = 0 V)

| Symbol           | Parameter  | Condition  | V <sub>CC</sub><br>V | V <sub>EE</sub><br>V | Typ  | Unit |
|------------------|--|--|----------------------|----------------------|------|------|
|                  |  |  |                      |                      | 25°C |      |
| BW               | Maximum On-Channel Bandwidth or Minimum Frequency Response | V <sub>IS</sub> = 1/2 (V <sub>CC</sub> - V <sub>EE</sub> )<br>Source Amplitude = 0 dBm<br>(Figures 10 and 22)  | 3.0                  | 0.0                  | 145  | MHz  |
|                  |  |  | 4.5                  | 0.0                  | 165  |      |
|                  |  |  | 6.0                  | 0.0                  | 180  |      |
|                  |  |  | 3.0                  | -3.0                 | 180  |      |
| V <sub>ISO</sub> | Off-Channel Feedthrough Isolation                          | f = 100 kHz; V <sub>IS</sub> = 1/2 (V <sub>CC</sub> - V <sub>EE</sub> )<br>Source = 0 dBm<br>(Figures 12 and 22)   | 3.0                  | 0.0                  | -93  | dB   |
|                  |  |  | 4.5                  | 0.0                  | -93  |      |
|                  |  |  | 6.0                  | 0.0                  | -93  |      |
|                  |  |  | 3.0                  | -3.0                 | -93  |      |
| V <sub>ONL</sub> | Maximum Feedthrough On Loss                                | V <sub>IS</sub> = 1/2 (V <sub>CC</sub> - V <sub>EE</sub> )<br>Source = 0 dBm<br>(Figures 10 and 22)  | 3.0                  | 0.0                  | -2   | dB   |
|                  |  |  | 4.5                  | 0.0                  | -2   |      |
|                  |  |  | 6.0                  | 0.0                  | -2   |      |
|                  |  |  | 3.0                  | -3.0                 | -2   |      |
| Q                | Charge Injection   | V <sub>IN</sub> = V <sub>CC</sub> to V <sub>EE</sub> , f <sub>IS</sub> = 1 kHz, t <sub>r</sub> = t <sub>f</sub> = 3 ns<br>R <sub>IS</sub> = 0 Ω, C <sub>L</sub> = 1000 pF, Q = C <sub>L</sub> * ΔV <sub>OUT</sub><br>(Figures 16 and 23) | 5.0                  | 0.0                  | 9.0  | pC   |
|                  |  |  | 3.0                  | -3.0                 | 12   |      |
| THD              | Total Harmonic Distortion THD + Noise                      | f <sub>IS</sub> = 1 MHz, R <sub>L</sub> = 10 KΩ, C <sub>L</sub> = 50 pF,<br>V <sub>IS</sub> = 5.0 V <sub>PP</sub> sine wave<br>V <sub>IS</sub> = 6.0 V <sub>PP</sub> sine wave<br>(Figure 13)  | 6.0                  | 0.0                  | 0.10 | %    |
|                  |  |  | 3.0                  | -3.0                 | 0.05 |      |

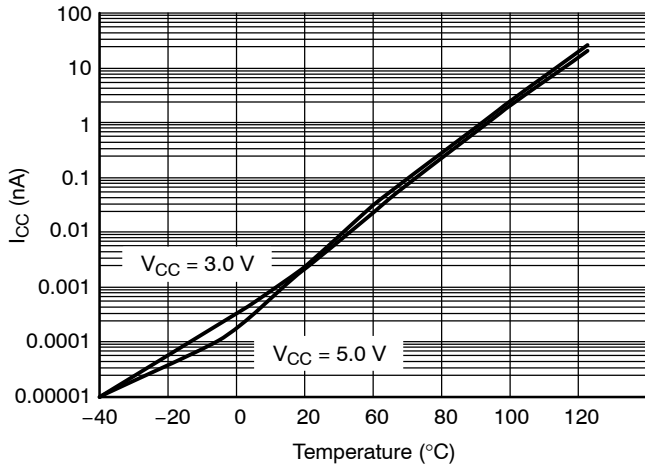

Figure 3.  $I_{CC}$  versus Temp,  $V_{CC} = 3\text{ V}$  and  $5\text{ V}$

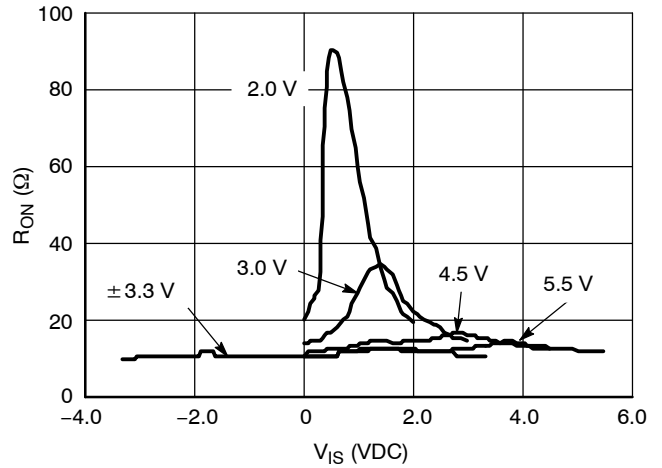

Figure 4.  $R_{ON}$  versus  $V_{CC}$ , Temp =  $25^{\circ}\text{C}$

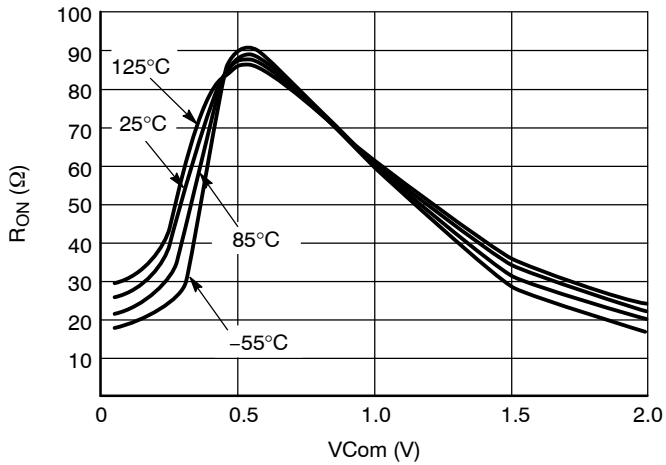

Figure 5. Typical On Resistance  
 $V_{CC} = 2.0\text{ V}$ ,  $V_{EE} = 0\text{ V}$

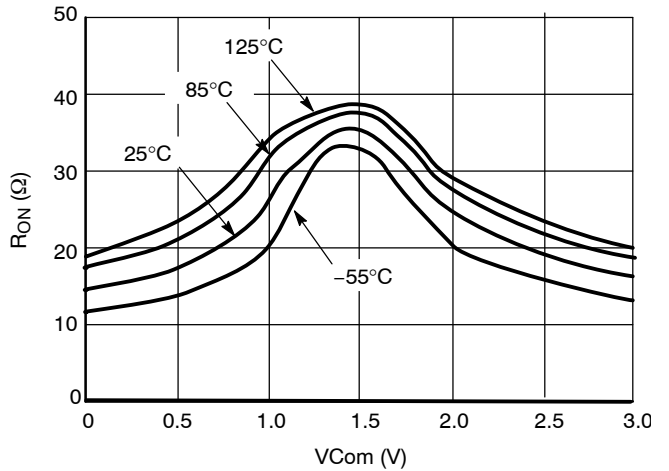

Figure 6. Typical On Resistance  
 $V_{CC} = 3.0\text{ V}$ ,  $V_{EE} = 0\text{ V}$

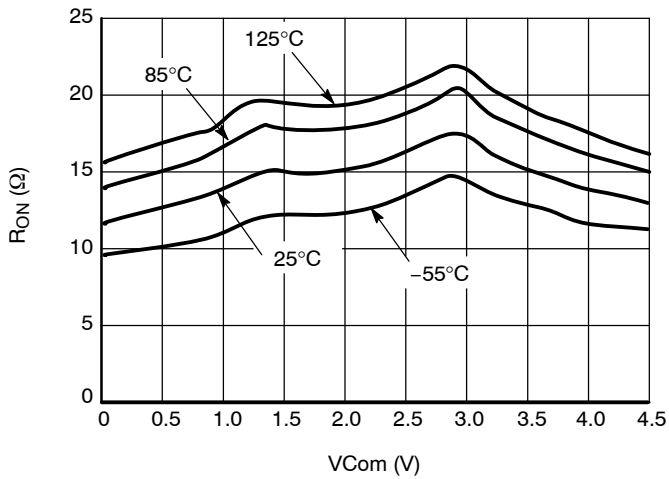

Figure 7. Typical On Resistance  
 $V_{CC} = 4.5\text{ V}$ ,  $V_{EE} = 0\text{ V}$

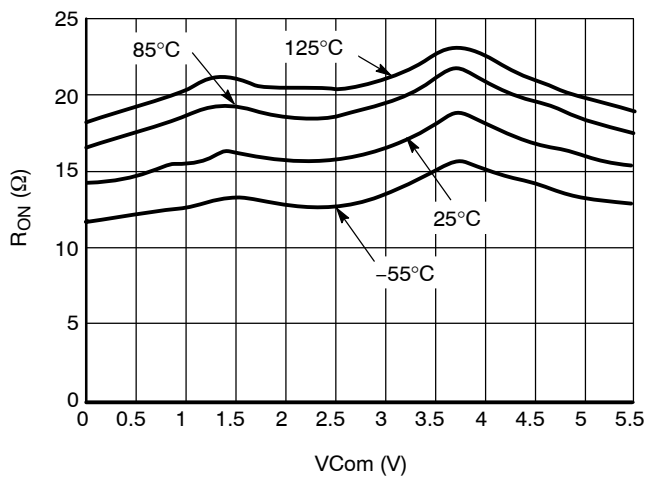
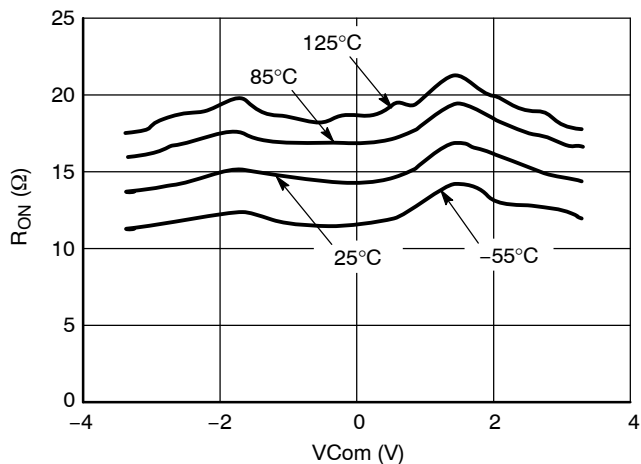
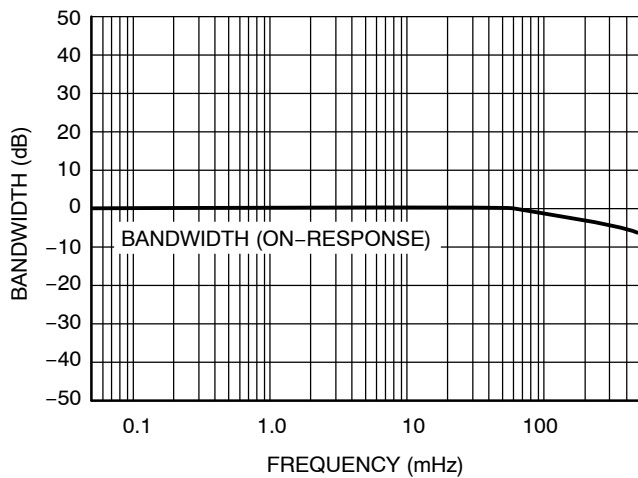

Figure 8. Typical On Resistance  
 $V_{CC} = 5.5\text{ V}$ ,  $V_{EE} = 0\text{ V}$

# NLAS4053



**Figure 9. Typical On Resistance**  
 $V_{CC} = 3.3$  V,  $V_{EE} = -3.3$  V



**Figure 10. Bandwidth**

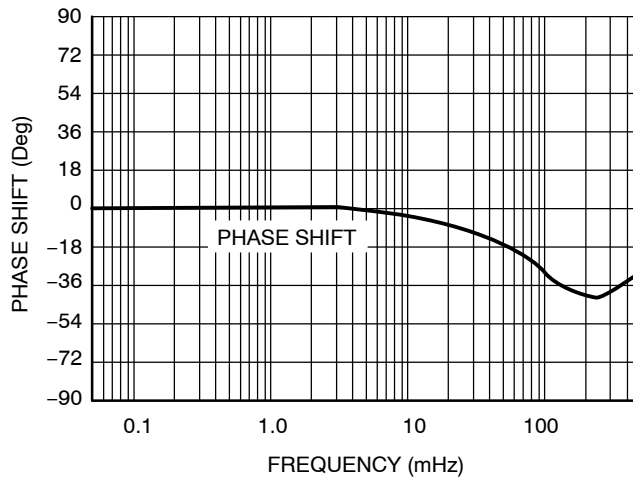

**Figure 11. Phase Shift**

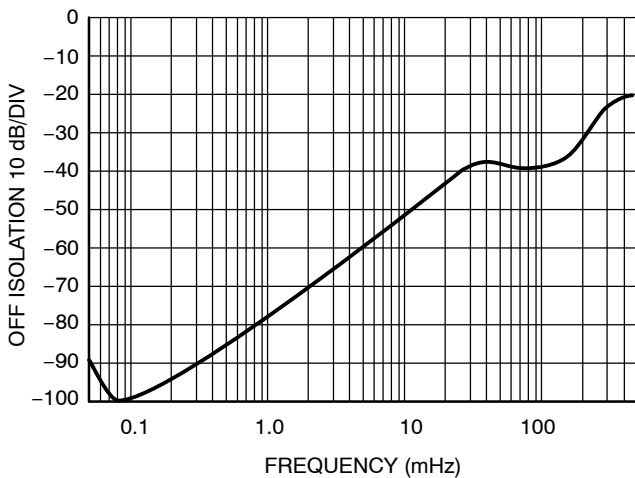

**Figure 12. Off Isolation**

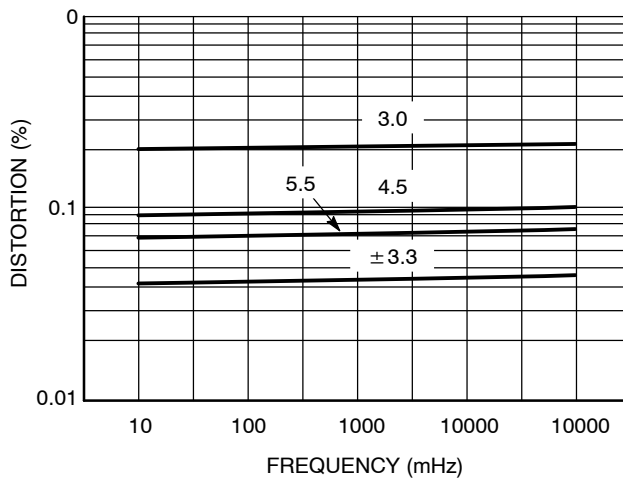

**Figure 13. Total Harmonic Distortion**



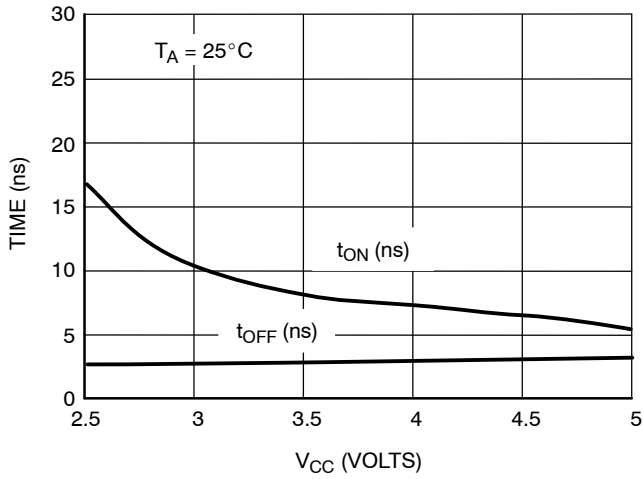

Figure 14.  $t_{ON}$  and  $t_{OFF}$  versus  $V_{CC}$

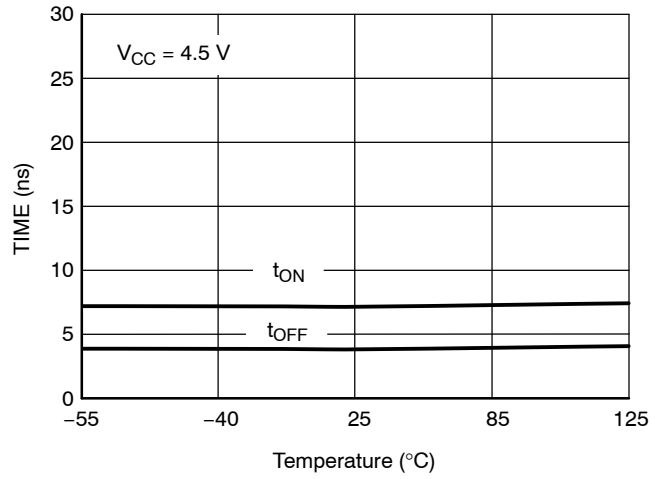

Figure 15.  $t_{ON}$  and  $t_{OFF}$  versus Temp

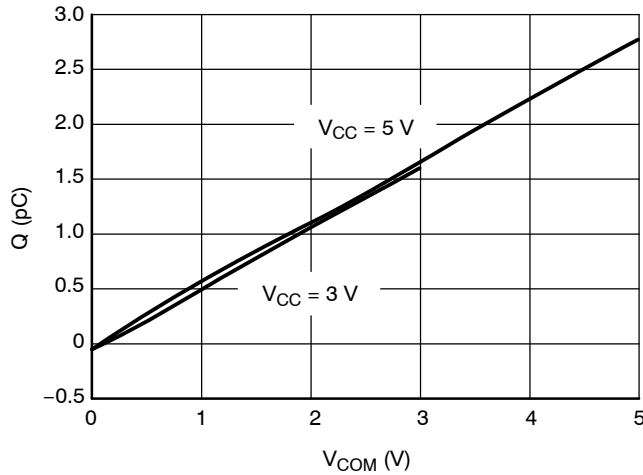

Figure 16. Charge Injection versus COM Voltage

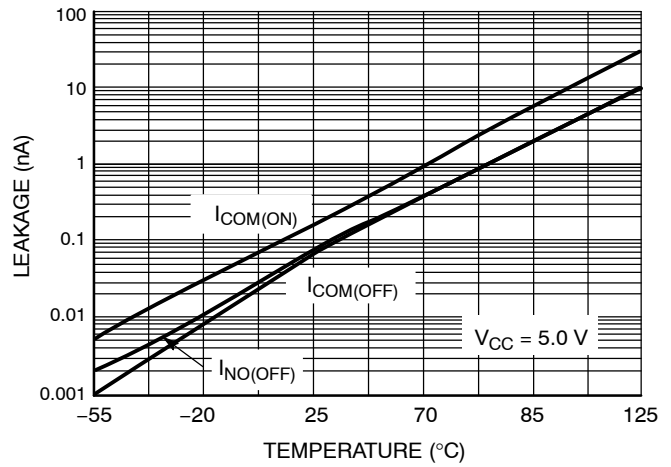

Figure 17. Switch Leakage versus Temperature

# NLAS4053

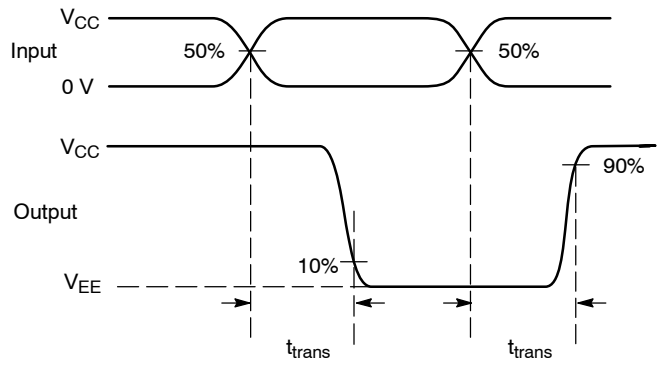
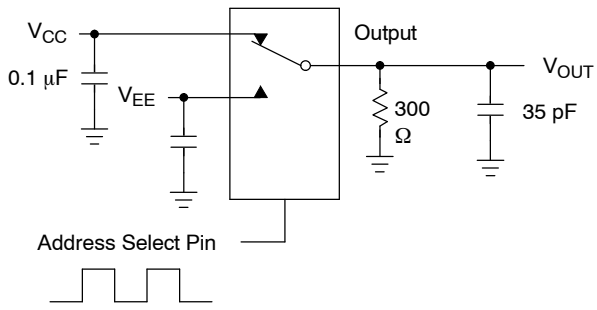

Figure 18. Channel Selection Propagation Delay

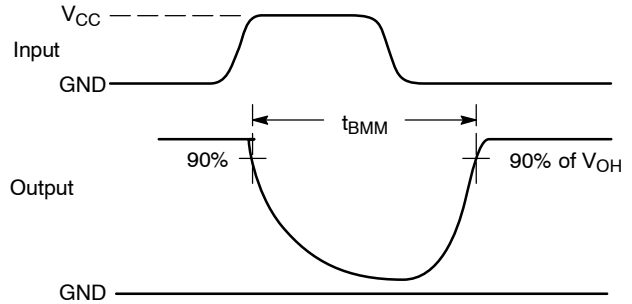
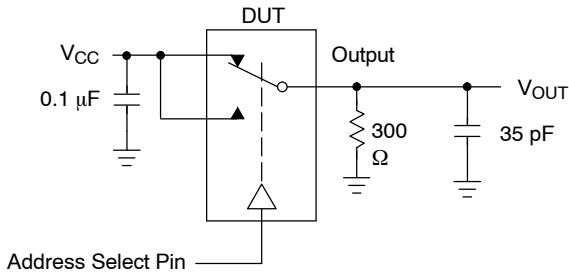

Figure 19.  $t_{\text{BMM}}$  (Time Break-Before-Make)

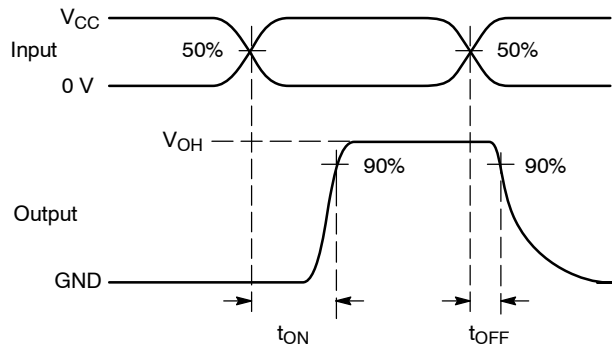
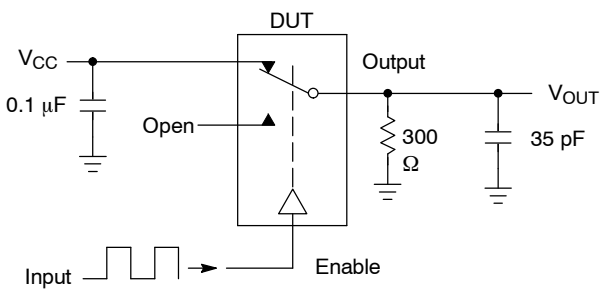

Figure 20.  $t_{\text{ON}}/t_{\text{OFF}}$

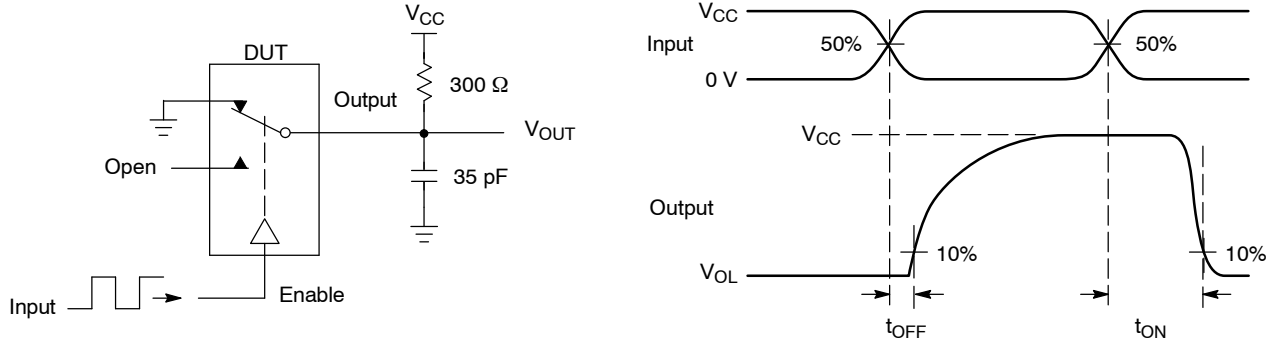
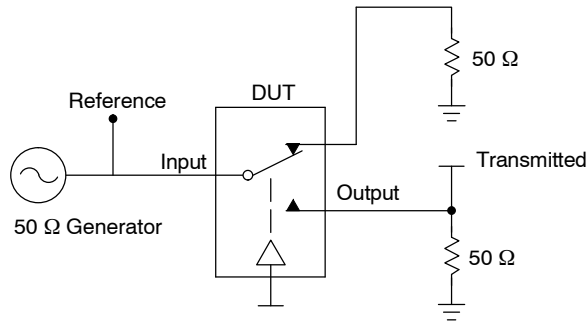

Figure 21.  $t_{ON}/t_{OFF}$



Channel switch control/s test socket is normalized. Off isolation is measured across an off channel. On loss is the bandwidth of an On switch.  $V_{ISO}$ , Bandwidth and  $V_{ONL}$  are independent of the input signal direction.

$$V_{ISO} = \text{Off Channel Isolation} = 20 \text{ Log} \left( \frac{V_{OUT}}{V_{IN}} \right) \text{ for } V_{IN} \text{ at } 100 \text{ kHz}$$

$$V_{ONL} = \text{On Channel Loss} = 20 \text{ Log} \left( \frac{V_{OUT}}{V_{IN}} \right) \text{ for } V_{IN} \text{ at } 100 \text{ kHz to } 50 \text{ MHz}$$

Bandwidth (BW) = the frequency 3 dB below  $V_{ONL}$

Figure 22. Off Channel Isolation/On Channel Loss (BW)/Crosstalk (On Channel to Off Channel)/ $V_{ONL}$

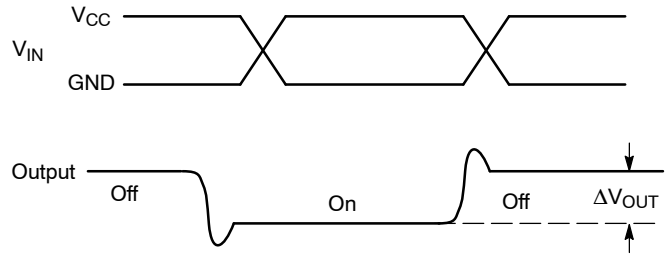
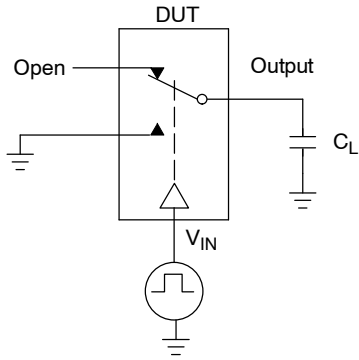

Figure 23. Charge Injection: (Q)

TYPICAL OPERATION

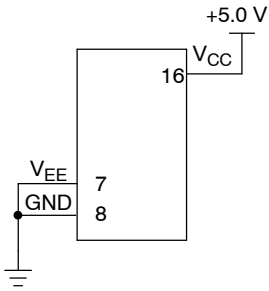

Figure 24. 5.0 Volts Single Supply  
 $V_{CC} = 5.0 \text{ V}$ ,  $V_{EE} = 0$

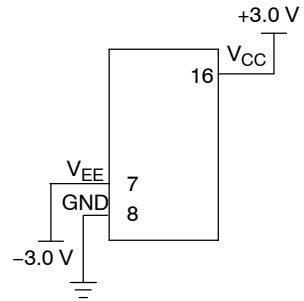
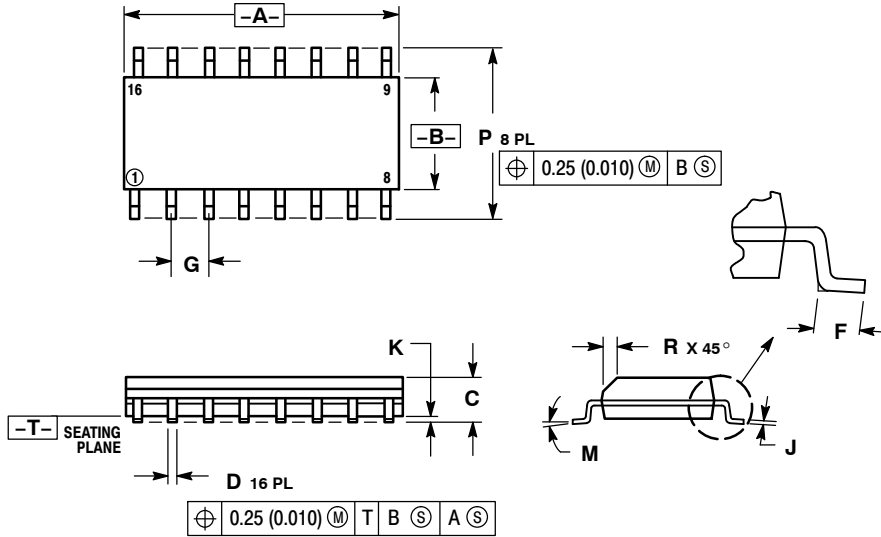

Figure 25. Dual Supply  
 $V_{CC} = 3.0 \text{ V}$ ,  $V_{EE} = -3.0 \text{ V}$

# NLAS4053

## PACKAGE DIMENSIONS

SOIC-16  
D SUFFIX  
CASE 751B-05  
ISSUE K



NOTES:

1. DIMENSIONING AND TOLERANCING PER ANSI Y14.5M, 1982.
2. CONTROLLING DIMENSION: MILLIMETER.
3. DIMENSIONS A AND B DO NOT INCLUDE MOLD PROTRUSION.
4. MAXIMUM MOLD PROTRUSION 0.15 (0.006) PER SIDE.
5. DIMENSION D DOES NOT INCLUDE DAMBAR PROTRUSION. ALLOWABLE DAMBAR PROTRUSION SHALL BE 0.127 (0.005) TOTAL IN EXCESS OF THE D DIMENSION AT MAXIMUM MATERIAL CONDITION.

| DIM | MILLIMETERS |       | INCHES    |       |
|-----|-------------|-------|-----------|-------|
|     | MIN         | MAX   | MIN       | MAX   |
| A   | 9.80        | 10.00 | 0.386     | 0.393 |
| B   | 3.80        | 4.00  | 0.150     | 0.157 |
| C   | 1.35        | 1.75  | 0.054     | 0.068 |
| D   | 0.35        | 0.49  | 0.014     | 0.019 |
| F   | 0.40        | 1.25  | 0.016     | 0.049 |
| G   | 1.27 BSC    |       | 0.050 BSC |       |
| J   | 0.19        | 0.25  | 0.008     | 0.009 |
| K   | 0.10        | 0.25  | 0.004     | 0.009 |
| M   | 0°          | 7°    | 0°        | 7°    |
| P   | 5.80        | 6.20  | 0.229     | 0.244 |
| R   | 0.25        | 0.50  | 0.010     | 0.019 |

### SOLDERING FOOTPRINT

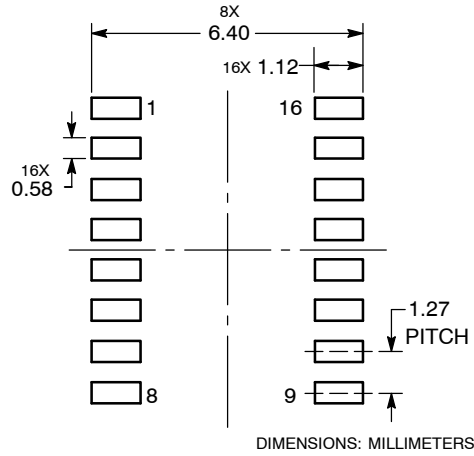

# NLAS4053

## PACKAGE DIMENSIONS

TSSOP-16  
DT SUFFIX  
CASE 948F-01  
ISSUE B

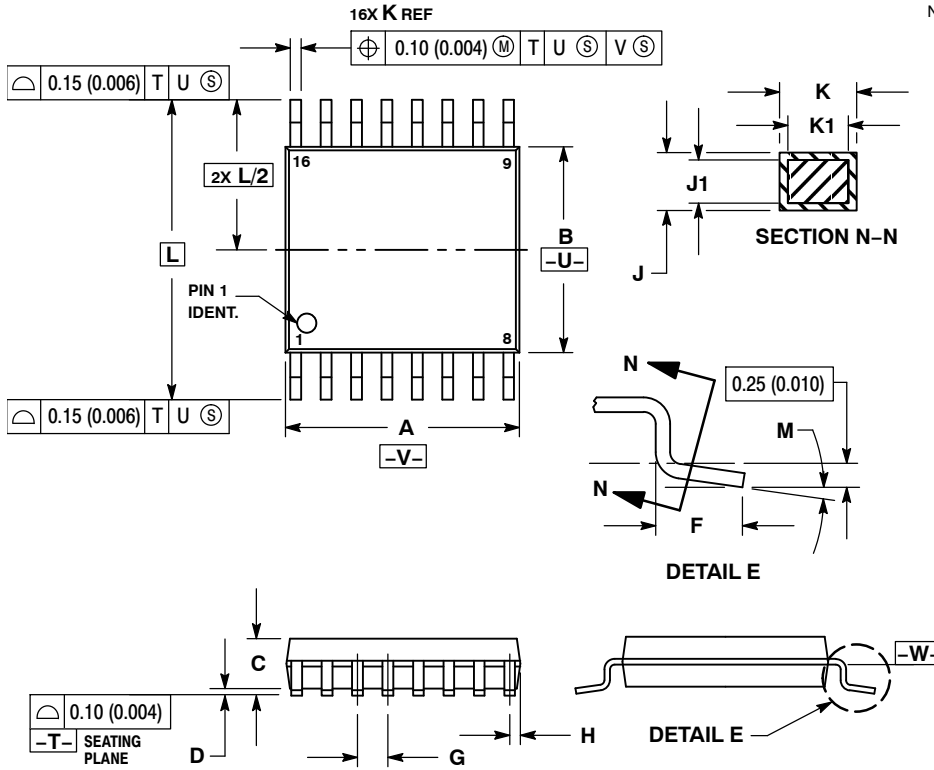

### NOTES:

1. DIMENSIONING AND TOLERANCING PER ANSI Y14.5M, 1982.
2. CONTROLLING DIMENSION: MILLIMETER.
3. DIMENSION A DOES NOT INCLUDE MOLD FLASH. PROTRUSIONS OR GATE BURRS. MOLD FLASH OR GATE BURRS SHALL NOT EXCEED 0.15 (0.006) PER SIDE.
4. DIMENSION B DOES NOT INCLUDE INTERLEAD FLASH OR PROTRUSION. INTERLEAD FLASH OR PROTRUSION SHALL NOT EXCEED 0.25 (0.010) PER SIDE.
5. DIMENSION K DOES NOT INCLUDE DAMBAR PROTRUSION. ALLOWABLE DAMBAR PROTRUSION SHALL BE 0.08 (0.003) TOTAL IN EXCESS OF THE K DIMENSION AT MAXIMUM MATERIAL CONDITION.
6. TERMINAL NUMBERS ARE SHOWN FOR REFERENCE ONLY.
7. DIMENSION A AND B ARE TO BE DETERMINED AT DATUM PLANE  $-W-$ .

| DIM | MILLIMETERS |      | INCHES    |       |
|-----|-------------|------|-----------|-------|
|     | MIN         | MAX  | MIN       | MAX   |
| A   | 4.90        | 5.10 | 0.193     | 0.200 |
| B   | 4.30        | 4.50 | 0.169     | 0.177 |
| C   | ---         | 1.20 | ---       | 0.047 |
| D   | 0.05        | 0.15 | 0.002     | 0.006 |
| F   | 0.50        | 0.75 | 0.020     | 0.030 |
| G   | 0.65 BSC    |      | 0.026 BSC |       |
| H   | 0.18        | 0.28 | 0.007     | 0.011 |
| J   | 0.09        | 0.20 | 0.004     | 0.008 |
| J1  | 0.09        | 0.16 | 0.004     | 0.006 |
| K   | 0.19        | 0.30 | 0.007     | 0.012 |
| K1  | 0.19        | 0.25 | 0.007     | 0.010 |
| L   | 6.40 BSC    |      | 0.252 BSC |       |
| M   | 0°          | 8°   | 0°        | 8°    |

### SOLDERING FOOTPRINT

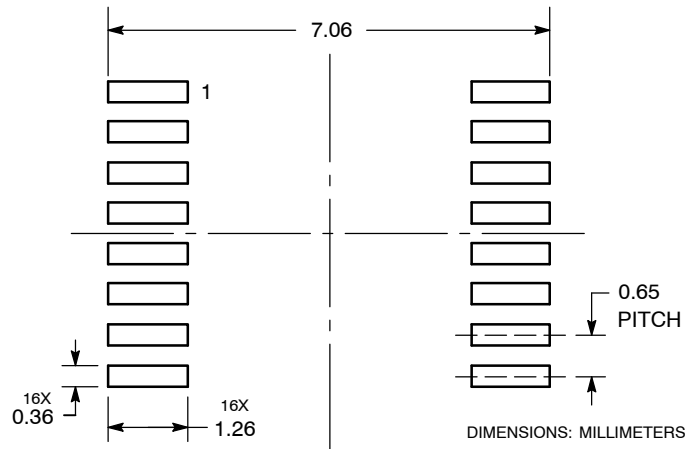

**ON Semiconductor** and **ON** are registered trademarks of Semiconductor Components Industries, LLC (SCILLC). SCILLC reserves the right to make changes without further notice to any products herein. SCILLC makes no warranty, representation or guarantee regarding the suitability of its products for any particular purpose, nor does SCILLC assume any liability arising out of the application or use of any product or circuit, and specifically disclaims any and all liability, including without limitation special, consequential or incidental damages. "Typical" parameters which may be provided in SCILLC data sheets and/or specifications can and do vary in different applications and actual performance may vary over time. All operating parameters, including "Typicals" must be validated for each customer application by customer's technical experts. SCILLC does not convey any license under its patent rights nor the rights of others. SCILLC products are not designed, intended, or authorized for use as components in systems intended for surgical implant into the body, or other applications intended to support or sustain life, or for any other application in which the failure of the SCILLC product could create a situation where personal injury or death may occur. Should Buyer purchase or use SCILLC products for any such unintended or unauthorized application, Buyer shall indemnify and hold SCILLC and its officers, employees, subsidiaries, affiliates, and distributors harmless against all claims, costs, damages, and expenses, and reasonable attorney fees arising out of, directly or indirectly, any claim of personal injury or death associated with such unintended or unauthorized use, even if such claim alleges that SCILLC was negligent regarding the design or manufacture of the part. SCILLC is an Equal Opportunity/Affirmative Action Employer. This literature is subject to all applicable copyright laws and is not for resale in any manner.

## PUBLICATION ORDERING INFORMATION

### LITERATURE FULFILLMENT:

Literature Distribution Center for ON Semiconductor  
P.O. Box 5163, Denver, Colorado 80217 USA  
**Phone:** 303-675-2175 or 800-344-3860 Toll Free USA/Canada  
**Fax:** 303-675-2176 or 800-344-3867 Toll Free USA/Canada  
**Email:** [orderlit@onsemi.com](mailto:orderlit@onsemi.com)

**N. American Technical Support:** 800-282-9855 Toll Free  
USA/Canada  
**Europe, Middle East and Africa Technical Support:**  
Phone: 421 33 790 2910  
**Japan Customer Focus Center**  
Phone: 81-3-5773-3850

**ON Semiconductor Website:** [www.onsemi.com](http://www.onsemi.com)

**Order Literature:** <http://www.onsemi.com/orderlit>

For additional information, please contact your local  
Sales Representative