



Chipsmall Limited consists of a professional team with an average of over 10 year of expertise in the distribution of electronic components. Based in Hongkong, we have already established firm and mutual-benefit business relationships with customers from,Europe,America and south Asia,supplying obsolete and hard-to-find components to meet their specific needs.

With the principle of "Quality Parts,Customers Priority,Honest Operation,and Considerate Service",our business mainly focus on the distribution of electronic components. Line cards we deal with include Microchip,ALPS,ROHM,Xilinx,Pulse,ON,Everlight and Freescale. Main products comprise IC,Modules,Potentiometer,IC Socket,Relay,Connector.Our parts cover such applications as commercial,industrial, and automotives areas.

We are looking forward to setting up business relationship with you and hope to provide you with the best service and solution. Let us make a better world for our industry!



## Contact us

Tel: +86-755-8981 8866 Fax: +86-755-8427 6832

Email & Skype: info@chipsmall.com Web: www.chipsmall.com

Address: A1208, Overseas Decoration Building, #122 Zhenhua RD., Futian, Shenzhen, China



# NLSF302

## Quad 2-Input NOR Gate

The NLSF302 is an advanced high speed CMOS 2-input NOR gate fabricated with silicon gate CMOS technology. It achieves high speed operation similar to equivalent Bipolar Schottky TTL while maintaining CMOS low power dissipation.

The internal circuit is composed of three stages, including a buffer output which provides high noise immunity and stable output. The inputs tolerate voltages up to 7.0 V, allowing the interface of 5.0 V systems to 3.0 V systems.

### Features

- High Speed:  $t_{PD} = 3.6 \text{ ns}$  (Typ) at  $V_{CC} = 5.0 \text{ V}$
- Low Power Dissipation:  $I_{CC} = 2.0 \mu\text{A}$  (Max) at  $T_A = 25^\circ\text{C}$
- High Noise Immunity:  $V_{NIH} = V_{NIL} = 28\% V_{CC}$
- Power Down Protection Provided on Inputs
- Balanced Propagation Delays
- Designed for 2.0 V to 5.5 V Operating Range
- Low Noise:  $V_{OLP} = 0.8 \text{ V}$  (Max)
- Function Compatible with Other Standard Logic Families
- QFN-16 Package
- Latchup Performance Exceeds 300 mA
- ESD Performance: Human Body Model; > 2000 V,  
Machine Model > 200 V
- Chip Complexity: 40 FETs or 10 Equivalent Gates
- Pb-Free Package is Available\*

**FUNCTION TABLE**

Inputs		Output
A	B	Y
L	L	H
L	H	L
H	L	L
H	H	L



**ON Semiconductor®**

<http://onsemi.com>



1

**QFN-16  
MN SUFFIX  
CASE 485G**

### MARKING DIAGRAM

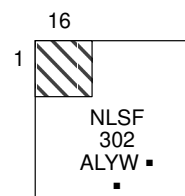

NLSF302 = Device Code  
 A = Assembly Location  
 L = Wafer Lot  
 Y = Year  
 W = Work Week  
 ■ = Pb-Free Package  
 (Note: Microdot may be in either location)

### ORDERING INFORMATION

Device	Package	Shipping†
NLSF302MNR2	QFN-16	3000/Tape & Reel
NLSF302MNR2G	QFN-16 (Pb-Free)	3000/Tape & Reel

†For information on tape and reel specifications, including part orientation and tape sizes, please refer to our Tape and Reel Packaging Specifications Brochure, BRD8011/D.

\*For additional information on our Pb-Free strategy and soldering details, please download the ON Semiconductor Soldering and Mounting Techniques Reference Manual, SOLDERRM/D.

# NLSF302

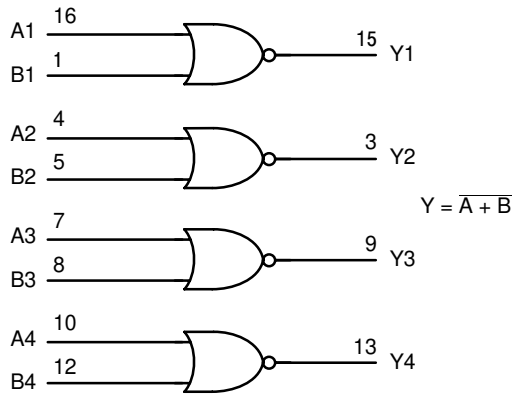

Figure 1. LOGIC DIAGRAM

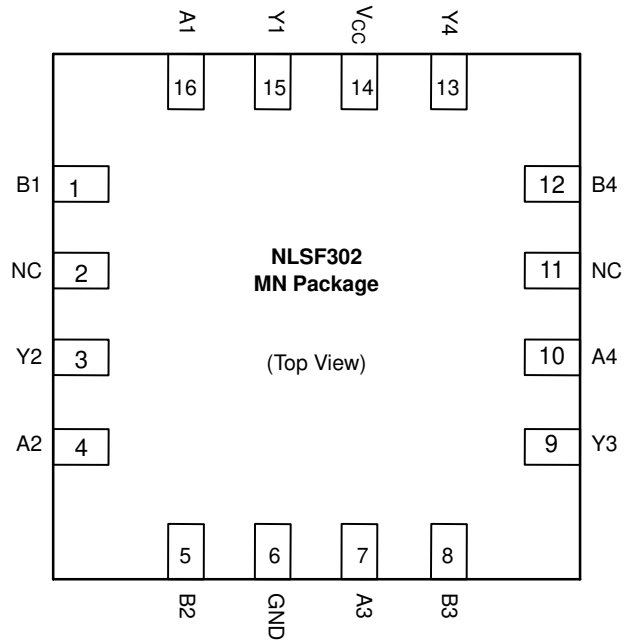

Figure 2. PIN ASSIGNMENT (QFN-16)

## MAXIMUM RATINGS

Parameter	Symbol	Value	Unit
DC Supply Voltage	$V_{CC}$	- 0.5 to + 7.0	V
DC Input Voltage	$V_{in}$	- 0.5 to + 7.0	V
DC Output Voltage	$V_{out}$	- 0.5 to $V_{CC} + 0.5$	V
Input Diode Current	$I_{IK}$	- 20	mA
Output Diode Current	$I_{OK}$	$\pm 20$	mA
DC Output Current, per Pin	$I_{out}$	$\pm 25$	mA
DC Supply Current, $V_{CC}$ and GND Pins	$I_{CC}$	$\pm 50$	mA
Power Dissipation in Still Air	$P_D$	450	mW
Storage Temperature	$T_{stg}$	- 65 to + 150	$^{\circ}C$

Stresses exceeding Maximum Ratings may damage the device. Maximum Ratings are stress ratings only. Functional operation above the Recommended Operating Conditions is not implied. Extended exposure to stresses above the Recommended Operating Conditions may affect device reliability.

This device contains protection circuitry to guard against damage due to high static voltages or electric fields. However, precautions must be taken to avoid applications of any voltage higher than maximum rated voltages to this high-impedance circuit. For proper operation,  $V_{in}$  and  $V_{out}$  should be constrained to the range  $GND \leq (V_{in} \text{ or } V_{out}) \leq V_{CC}$ . Unused inputs must always be tied to an appropriate logic voltage level (e.g., either GND or  $V_{CC}$ ). Unused outputs must be left open.

## RECOMMENDED OPERATING CONDITIONS

Parameter	Symbol	Min	Max	Unit
DC Supply Voltage	$V_{CC}$	2.0	5.5	V
DC Input Voltage	$V_{in}$	0	5.5	V
DC Output Voltage	$V_{out}$	0	$V_{CC}$	V
Operating Temperature	$T_A$	-40	+85	$^{\circ}C$
Input Rise and Fall Time	$t_r, t_f$	0	100	ns/V
		0	20	

$V_{CC} = 3.3 \text{ V} \pm 0.3 \text{ V}$   
 $V_{CC} = 5.0 \text{ V} \pm 0.5 \text{ V}$

# NLSF302

## DC ELECTRICAL CHARACTERISTICS

Parameter	Test Conditions	Symbol	V <sub>CC</sub> V	T <sub>A</sub> = 25°C			T <sub>A</sub> = - 40 to 85°C		Unit
				Min	Typ	Max	Min	Max	
Minimum High-Level Input Voltage		V <sub>IH</sub>	2.0 3.0 to 5.5	1.50 V <sub>CC</sub> × 0.7			1.50 V <sub>CC</sub> × 0.7		V
Maximum Low-Level Input Voltage		V <sub>IL</sub>	2.0 3.0 to 5.5			0.50 V <sub>CC</sub> × 0.3		0.50 V <sub>CC</sub> × 0.3	V
Minimum High-Level Output Voltage	V <sub>in</sub> = V <sub>IH</sub> or V <sub>IL</sub> I <sub>OH</sub> = -50 μA	V <sub>OH</sub>	2.0 3.0 4.5	1.9 2.9 4.4	2.0 3.0 4.5		1.9 2.9 4.4		V
	V <sub>in</sub> = V <sub>IH</sub> or V <sub>IL</sub> I <sub>OH</sub> = -4 mA I <sub>OH</sub> = -8 mA		3.0 4.5	2.58 3.94			2.48 3.80		
Maximum Low-Level Output Voltage	V <sub>in</sub> = V <sub>IH</sub> or V <sub>IL</sub> I <sub>OL</sub> = 50 μA	V <sub>OL</sub>	2.0 3.0 4.5		0.0 0.0 0.0	0.1 0.1 0.1		0.1 0.1 0.1	V
	V <sub>in</sub> = V <sub>IH</sub> or V <sub>IL</sub> I <sub>OL</sub> = 4 mA I <sub>OL</sub> = 8 mA		3.0 4.5			0.36 0.36		0.44 0.44	
Maximum Input Leakage Current	V <sub>in</sub> = 5.5 V or GND	I <sub>in</sub>	0 to 5.5			± 0.1		± 1.0	μA
Maximum Quiescent Supply Current	V <sub>in</sub> = V <sub>CC</sub> or GND	I <sub>CC</sub>	5.5			2.0		20.0	μA

## AC ELECTRICAL CHARACTERISTICS (Input t<sub>r</sub> = t<sub>f</sub> = 3.0ns)

Parameter	Test Conditions	Symbol	T <sub>A</sub> = 25°C			T <sub>A</sub> = - 40 to 85°C		Unit
			Min	Typ	Max	Min	Max	
Maximum Propagation Delay, Input A or B to Output Y	V <sub>CC</sub> = 3.3 ± 0.3 V C <sub>L</sub> = 15 pF C <sub>L</sub> = 50 pF	t <sub>PLH</sub> , t <sub>PHL</sub>		5.6 8.1	7.9 11.4	1.0 1.0	9.5 13.0	ns
	V <sub>CC</sub> = 5.0 ± 0.5 V C <sub>L</sub> = 15 pF C <sub>L</sub> = 50 pF			3.6 5.1	5.5 7.5	1.0 1.0	6.5 8.5	
Maximum Input Capacitance		C <sub>in</sub>		4	10		10	pF
Power Dissipation Capacitance (Note 1)		C <sub>PD</sub>	Typical @ 25°C, V <sub>CC</sub> = 5.0 V					pF
			15					

1. C<sub>PD</sub> is defined as the value of the internal equivalent capacitance which is calculated from the operating current consumption without load. Average operating current can be obtained by the equation: I<sub>CC(OPP)</sub> = C<sub>PD</sub> • V<sub>CC</sub> • f<sub>in</sub> + I<sub>CC</sub>/4 (per gate). C<sub>PD</sub> is used to determine the no-load dynamic power consumption; P<sub>D</sub> = C<sub>PD</sub> • V<sub>CC</sub><sup>2</sup> • f<sub>in</sub> + I<sub>CC</sub> • V<sub>CC</sub>.

## NOISE CHARACTERISTICS (Input t<sub>r</sub> = t<sub>f</sub> = 3.0 ns, C<sub>L</sub> = 50 pF, V<sub>CC</sub> = 5.0V)

Characteristic	Symbol	T <sub>A</sub> = 25°C		Unit
		Typ	Max	
Quiet Output Maximum Dynamic V <sub>OL</sub>	V <sub>OLP</sub>	0.3	0.8	V
Quiet Output Minimum Dynamic V <sub>OL</sub>	V <sub>OLV</sub>	- 0.3	- 0.8	V
Minimum High Level Dynamic Input Voltage	V <sub>IHD</sub>		3.5	V
Maximum Low Level Dynamic Input Voltage	V <sub>ILD</sub>		1.5	V

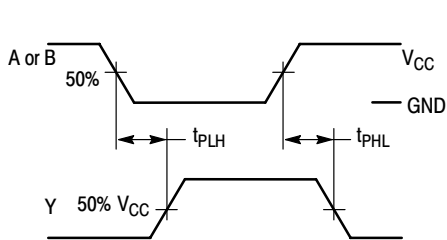
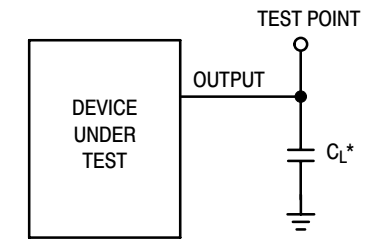

Figure 3. Switching Waveforms



\*Includes all probe and jig capacitance

Figure 4. Test Circuit

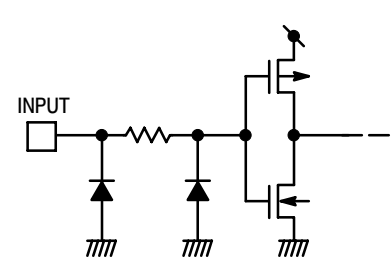
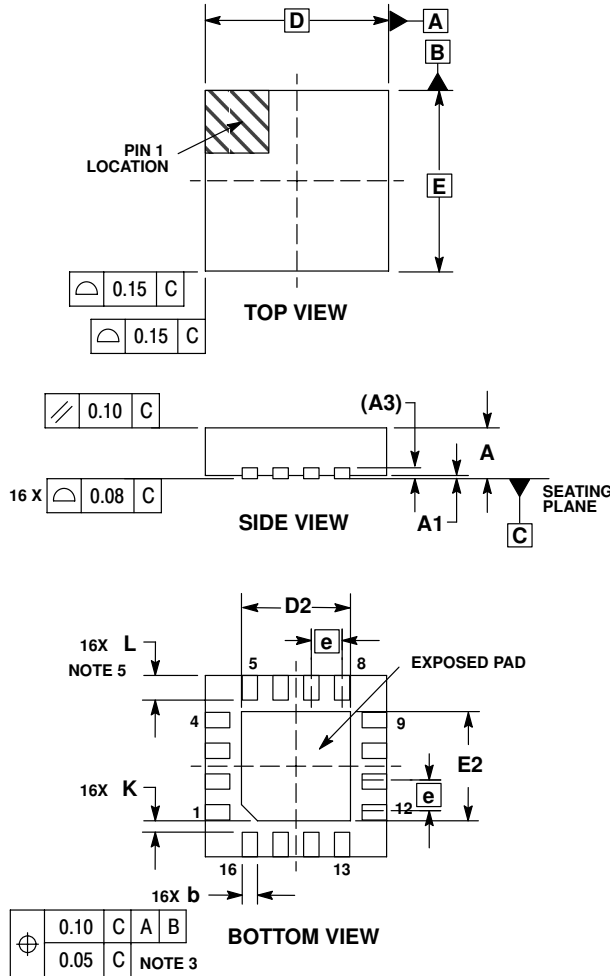

Figure 5. Input Equivalent Circuit

# NLSF302

## PACKAGE DIMENSIONS

16 PIN QFN  
CASE 485G-01  
ISSUE C



### NOTES:

1. DIMENSIONING AND TOLERANCING PER ASME Y14.5M, 1994.
2. CONTROLLING DIMENSION: MILLIMETERS.
3. DIMENSION b APPLIES TO PLATED TERMINAL AND IS MEASURED BETWEEN 0.25 AND 0.30 MM FROM TERMINAL.
4. COPLANARITY APPLIES TO THE EXPOSED PAD AS WELL AS THE TERMINALS.
5.  $L_{max}$  CONDITION CAN NOT VIOLATE 0.2 MM MINIMUM SPACING BETWEEN LEAD TIP AND FLAG

MILLIMETERS		
DIM	MIN	MAX
A	0.80	1.00
A1	0.00	0.05
A3	0.20 REF	
b	0.18	0.30
D	3.00	BSC
D2	1.65	1.85
E	3.00	BSC
E2	1.65	1.85
e	0.50	BSC
K	0.18	TYP
L	0.30	0.50

**ON Semiconductor** and **ON** are registered trademarks of Semiconductor Components Industries, LLC (SCILLC). SCILLC reserves the right to make changes without further notice to any products herein. SCILLC makes no warranty, representation or guarantee regarding the suitability of its products for any particular purpose, nor does SCILLC assume any liability arising out of the application or use of any product or circuit, and specifically disclaims any and all liability, including without limitation special, consequential or incidental damages. "Typical" parameters which may be provided in SCILLC data sheets and/or specifications can and do vary in different applications and actual performance may vary over time. All operating parameters, including "Typicals" must be validated for each customer application by customer's technical experts. SCILLC does not convey any license under its patent rights nor the rights of others. SCILLC products are not designed, intended, or authorized for use as components in systems intended for surgical implant into the body, or other applications intended to support or sustain life, or for any other application in which the failure of the SCILLC product could create a situation where personal injury or death may occur. Should Buyer purchase or use SCILLC products for any such unintended or unauthorized application, Buyer shall indemnify and hold SCILLC and its officers, employees, subsidiaries, affiliates, and distributors harmless against all claims, costs, damages, and expenses, and reasonable attorney fees arising out of, directly or indirectly, any claim of personal injury or death associated with such unintended or unauthorized use, even if such claim alleges that SCILLC was negligent regarding the design or manufacture of the part. SCILLC is an Equal Opportunity/Affirmative Action Employer. This literature is subject to all applicable copyright laws and is not for resale in any manner.

### PUBLICATION ORDERING INFORMATION

**LITERATURE FULFILLMENT:**  
Literature Distribution Center for ON Semiconductor  
P.O. Box 5163, Denver, Colorado 80217 USA  
**Phone:** 303-675-2175 or 800-344-3860 Toll Free USA/Canada  
**Fax:** 303-675-2176 or 800-344-3867 Toll Free USA/Canada  
**Email:** orderlit@onsemi.com

**N. American Technical Support:** 800-282-9855 Toll Free  
USA/Canada  
**Europe, Middle East and Africa Technical Support:**  
Phone: 421 33 790 2910  
**Japan Customer Focus Center**  
Phone: 81-3-5773-3850

**ON Semiconductor Website:** [www.onsemi.com](http://www.onsemi.com)  
**Order Literature:** <http://www.onsemi.com/orderlit>  
For additional information, please contact your local Sales Representative