



Chipsmall Limited consists of a professional team with an average of over 10 year of expertise in the distribution of electronic components. Based in Hongkong, we have already established firm and mutual-benefit business relationships with customers from,Europe,America and south Asia,supplying obsolete and hard-to-find components to meet their specific needs.

With the principle of "Quality Parts,Customers Priority,Honest Operation,and Considerate Service",our business mainly focus on the distribution of electronic components. Line cards we deal with include Microchip,ALPS,ROHM,Xilinx,Pulse,ON,Everlight and Freescale. Main products comprise IC,Modules,Potentiometer,IC Socket,Relay,Connector.Our parts cover such applications as commercial,industrial, and automotives areas.

We are looking forward to setting up business relationship with you and hope to provide you with the best service and solution. Let us make a better world for our industry!



## Contact us

Tel: +86-755-8981 8866 Fax: +86-755-8427 6832

Email & Skype: info@chipsmall.com Web: www.chipsmall.com

Address: A1208, Overseas Decoration Building, #122 Zhenhua RD., Futian, Shenzhen, China



## NM93C13/C14 256-/1024-Bit Serial EEPROM

### General Description

The NM93C13/C14 is 256/1024, respectively, bits of CMOS electrically erasable memory divided into 16/64 16-bit registers. They are fabricated using Fairchild Semiconductor's floating-gate CMOS process for high speed, high reliability and low power. The NM93C13/C14 is available in an 8-pin SO package to save board space.

The serial interface of the NM93C13/C14 is MICROWIRE™ compatible for simple interface to standard microcontrollers and microprocessors. There are 7 instructions: Read, Erase/Write Enable, Erase, Erase All, Write, Write All, and Erase/Write Disable.

All programming cycles are completely self-timed for simplified operation. The ready/busy status is available on the DO pin to indicate the completion of a programming cycle.

### Features

- Typical active current 400  $\mu$ A; Typical standby current 25  $\mu$ A
- Reliable CMOS floating gate technology
- 4.5V to 5.5V operation in all modes
- MICROWIRE compatible serial I/O
- Self-timed programming cycle
- Device status indication during programming mode
- 15 years data retention
- Endurance: 100,000 read/write cycles minimum
- Packages available: 8-pin DIP, 8-pin SO

### Functional Diagram

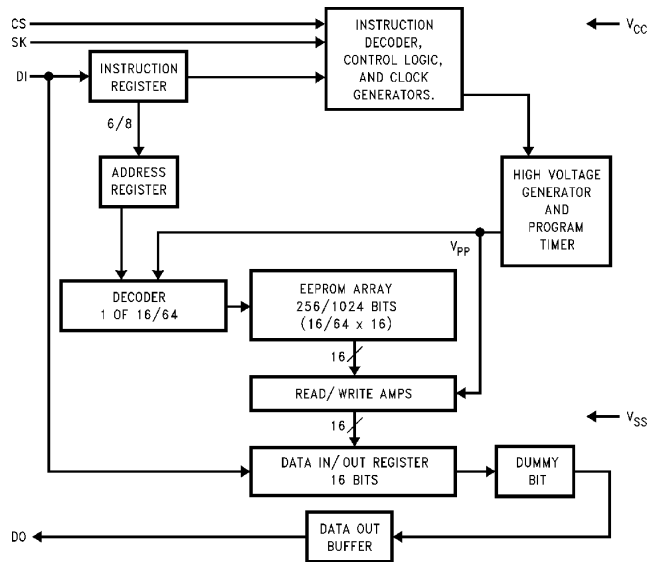

DS011291-1

## Connection Diagrams

Dual-In-Line Package (N)  
and 8-Pin SO (M8)

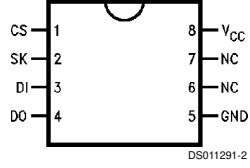

Top View  
See Package Number 8E and M08A  
Alternate SO Pinout (TM8)  
NM93C14 Only

Alternate SO Pinout (TM8)  
NM93C14 Only

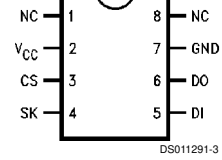

See Package M08A

## Ordering Information

Commercial Temp. Range (0°C to +70°C)

Order Number*
NM93C13N/NM93C14N
NM93C13M8/NM93C14M8
NM93C14TM8

## Pin Names

CS	Chip Select
SK	Serial Data Clock
DI	Serial Data Input
DO	Serial Data Output
GND	Ground
V <sub>CC</sub>	Power Supply

## Absolute Maximum Ratings (Note 1)

Ambient Storage Temperature	-65°C to +150°C
All Input or Output Voltages with Respect to Ground	+6.5V to -0.3V
Lead Temp. (Soldering, 10 sec.)	+300°C
ESD Rating	2000V

## Operating Conditions

Ambient Operating Temperature	NM93C13–NM93C14	0°C to +70°C
Power Supply		4.5V to 5.5V

## DC and AC Electrical Characteristics (Note 2)

$V_{CC} = 5.0V \pm 10\%$  (unless otherwise specified)

Symbol	Parameter	Conditions	Min	Max	Units
$I_{CC1}$	Operating Current	CS = $V_{IH}$ , SK = 1 MHz		4	mA
$I_{CC3}$	Standby Current	CS = 0V		200	$\mu$ A
$I_{IL}$	Input Leakage	$V_{IN} = 0V$ to $V_{CC}$	-10	10	$\mu$ A
$I_{OL}$	Output Leakage	$V_{IN} = 0V$ to $V_{CC}$	-10	10	$\mu$ A
$V_{IL}$	Input Low Voltage		-0.1	0.8	V
$V_{IH}$	Input High Voltage		2	$V_{CC} + 1$	V
$V_{OL1}$	Output Low Voltage	$I_{OL} = 2.1$ mA		0.4	V
$V_{OH1}$	Output High Voltage	$I_{OH} = -400$ $\mu$ A	2.4		V
$V_{OL2}$	Output Low Voltage	$I_{OL} = 10$ $\mu$ A		0.2	V
$V_{OH2}$	Output High Voltage	$I_{OH} = -10$ $\mu$ A	$V_{CC} - 0.2$		V
$f_{SK}$	SK Clock Frequency			1	MHz
$t_{SKH}$	SK High Time	(Note 3)	300		ns
$t_{SKL}$	SK Low Time	(Note 3)	250		ns
$t_{SKS}$	SK Setup Time		50		ns
$t_{CS}$	Minimum CS Low Time		250		ns
$t_{CSS}$	CS Setup Time		50		ns
$t_{DH}$	D0 Hold Time		70		ns
$t_{DIS}$	DI Setup Time		100		ns
$t_{CSH}$	CS Hold Time		0		ns
$t_{DIH}$	DI Hold Time		20		ns
$t_{PD1}$	Output Delay to "1"			500	ns
$t_{PD0}$	Output Delay to "0"			500	ns
$t_{SV}$	CS to Status Valid			500	ns
$t_{DF}$	CS to DO in TRI-STATE®	CS = $V_{IL}$		100	ns
$t_{WP}$	Write Cycle Time			10	ms

## Capacitance (Note 4)

$T_A = 25^\circ\text{C}$   $f = 1$  MHz

Symbol	Test	Typ	Max	Units
$C_{OUT}$	Output Capacitance		5	pF
$C_{IN}$	Input Capacitance		5	pF

## AC Test Conditions

Output Load	1 TTL Gate and $C_L = 100$ pF
Input Pulse Levels	0.4V to 2.4V
Timing Measurement Reference Level	
Input	1V and 2V
Output	0.8V and 2V

**Note 1:** Stress above those listed under "Absolute Maximum Ratings" may cause permanent damage to the device. This is a stress rating only and functional operation of the device at these or any other conditions above those indicated in the operational sections of the specification is not implied. Exposure to absolute maximum rating conditions for extended periods may affect device reliability.

**Note 2:** 100% functional test; AC/DC parameters sample tested to 0.4% AQL.

**Note 3:** The SK frequency specification specifies a minimum SK clock period of 1  $\mu$ s, therefore in an SK clock cycle  $t_{SKH} + t_{SKL}$  must be greater than or equal to 1  $\mu$ s. For example, if the  $t_{SKL} = 500$  ns then the minimum  $t_{SKH} = 500$  ns in order to meet the SK frequency specification.

**Note 4:** This parameter is periodically sampled and not 100% tested.

## Functional Description

The NM93C13/C14 have 7 instructions as described below. Note that the MSB of any instruction is a "1" and is viewed as a start bit in the interface sequence. For the C13 and C14 the next 8 bits carry the op code and the 6-bit address for register selection.

### Read (READ):

The READ instruction outputs serial data on the DO pin. After a READ instruction is received, the instruction and address are decoded, followed by data transfer from the selected memory register into a 16-bit serial-out shift register. A dummy bit (logical 0) precedes the 16-bit data output string. Output data changes are initiated by a low to high transition of the SK clock.

### Erase/Write Enable (EWEN):

When  $V_{CC}$  is applied to the part, it powers up in the Erase/Write Disable (EWDS) state. Therefore, all programming modes must be preceded by an Erase/Write Enable (EWEN) instruction. Once an Erase/Write Enable instruction is executed, programming remains enabled until an Erase/Write Disable (EWDS) instruction is executed or  $V_{CC}$  is removed from the part.

### Erase (ERASE):

The ERASE instruction will program all bits in the specified register to the logical "1" state. CS is brought low following the loading of the last address bit. This falling edge of the CS pin initiates the self-timed programming cycle.

The DO pin indicates the READY/BUSY status of the chip if CS is brought high after a minimum of 500 ns ( $t_{CS}$ ). DO = logical "0" indicates that programming is still in progress. DO = logical "1" indicates that the register, at the address specified in the instruction, has been erased, and the part is ready for another instruction.

### Write (WRITE):

The WRITE instruction is followed by 16 bits of data to be written into the specified address. After the last bit of data is

put on the data-in (DI) pin, CS must be brought low before the next rising edge of the SK clock. This falling edge of CS initiates the self-timed programming cycle. The DO pin indicates the READY/BUSY status of the chip if CS is brought high after a minimum of 500 ns ( $t_{CS}$ ). DO = logical 0 indicates that programming is still in progress. DO = logical 1 indicates that the register at the address specified in the instruction has been written with the data pattern specified in the instruction and the part is ready for another instruction.

### Erase All (ERAL):

The ERAL instruction will simultaneously program all registers in the memory array and set each bit to the logical "1" state. The Erase All cycle is identical to the ERASE cycle except for the different op-code. As in the ERASE mode, the DO pin indicates the READY/BUSY status of the chip if CS is brought high after a minimum of 500 ns ( $t_{CS}$ ). The ERASE ALL instruction is not required, see (Note 5) .

### Write All (WRAL):

The WRAL instruction will simultaneously program all registers with the data pattern specified in the instruction. As in the WRITE mode, the DO pin indicates the READY/BUSY status of the chip if CS is brought high after a minimum of 500 ns ( $t_{CS}$ ).

### Erase/Write Disable (EWDS):

To protect against accidental data disturb, the Erase/Write Disable (EWDS) instruction disables all programming modes and should follow all programming operations. Execution of a READ instruction is independent of both the EWEN and EWDS instructions.

**Note 5:** The NM93C13/C14 devices do not require an "ERASE" or "ERASE ALL" prior to the "WRITE" and "WRITE ALL" instructions. The "ERASE" and "ERASE ALL" instructions are included to maintain compatibility with the NMOS NMC9346.

## Instruction Set for the NM93C13 and NM93C14

Instruction	SB	Op Code	Address	Data	Comments
READ	1	10	A5-A0		Reads data stored in memory at specified address.
EWEN	1	00	11XXXX		Write enable must precede all programming modes.
ERASE	1	11	A5-A0		Erase selected register.
WRITE	1	01	A5-A0	D15-D0	Writes selected register.
ERAL	1	00	10XXXX		Erases all registers.
WRAL	1	00	01XXXX	D15-D0	Writes all registers.
EWDS	1	00	00XXXX		Disables all programming instructions.

## Timing Diagrams

### Synchronous Data Timing

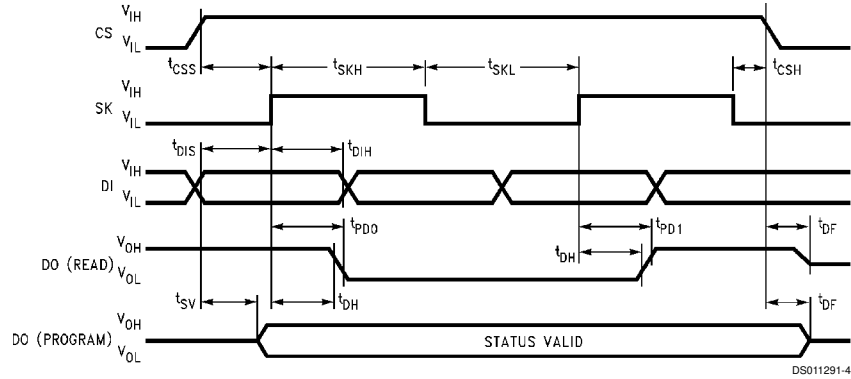

### READ:

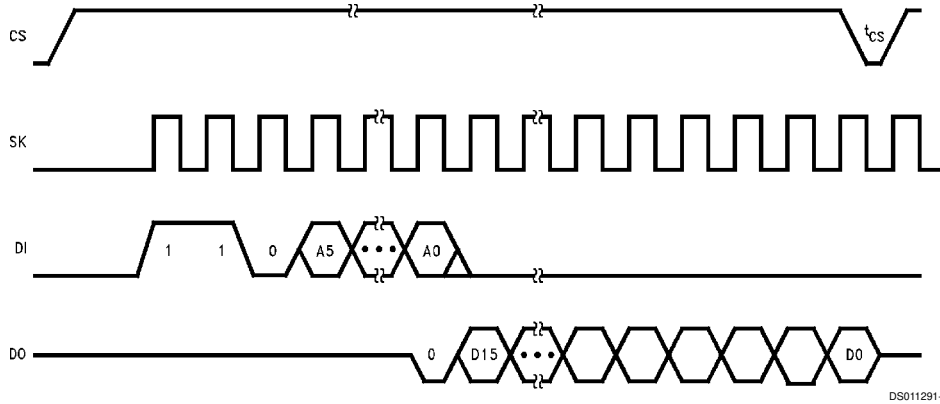

\*Address bits A5 and A4 become "don't care" for NM93C13.

### EWEN:

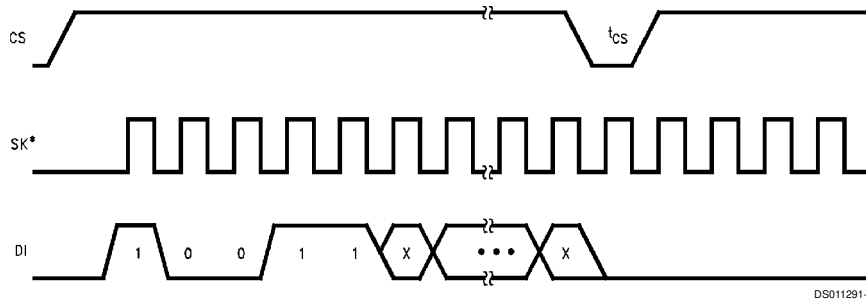

\*The NM93C13 and NM93C14 require a minimum of 9 clock cycles.

### Timing Diagrams (Continued)

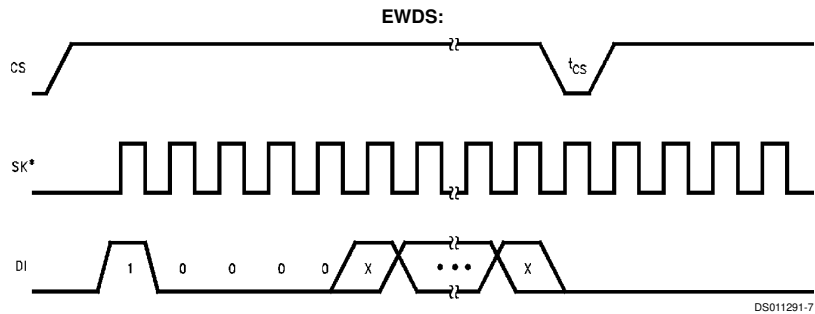

\*The NM93C13 and NM93C14 require a minimum of 9 clock cycles.

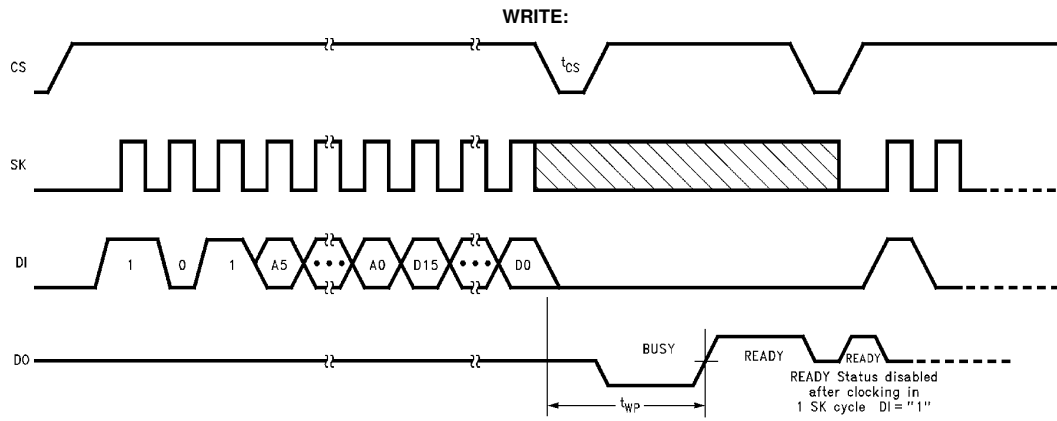

\*Address bit A5 and A4 become "don't care" for NM93C13.

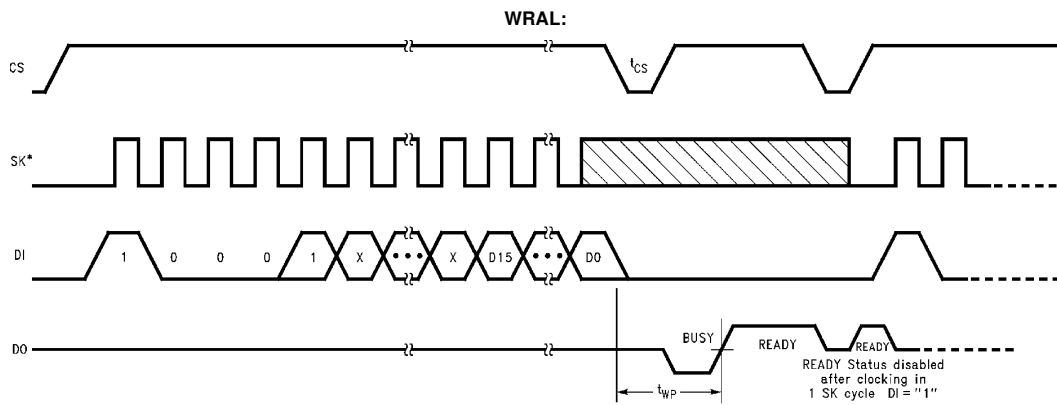

\*The NM93C13 and NM93C14 require a minimum of 9 clock cycles.

### Timing Diagrams (Continued)

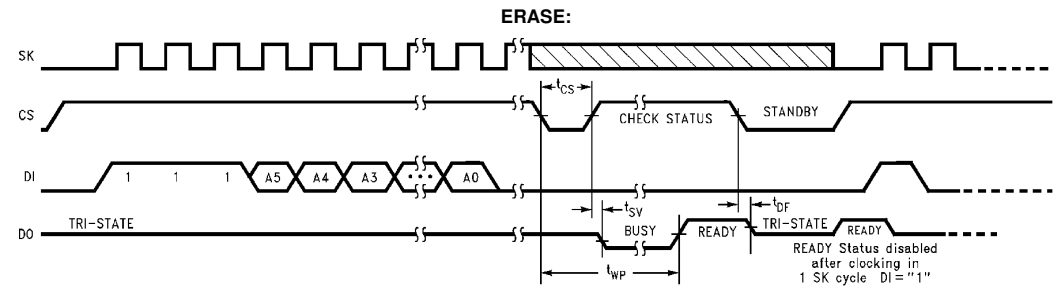

\*Address bits A5 and A4 are "don't care" for NM93C13.

DS011291-10

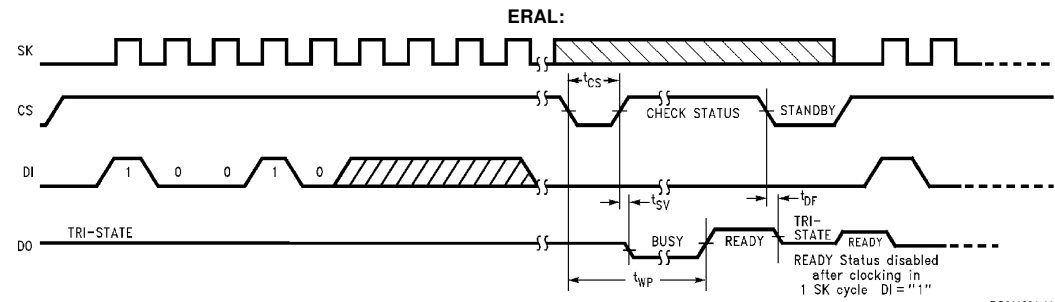

DS011291-11

Book  
Extract  
End



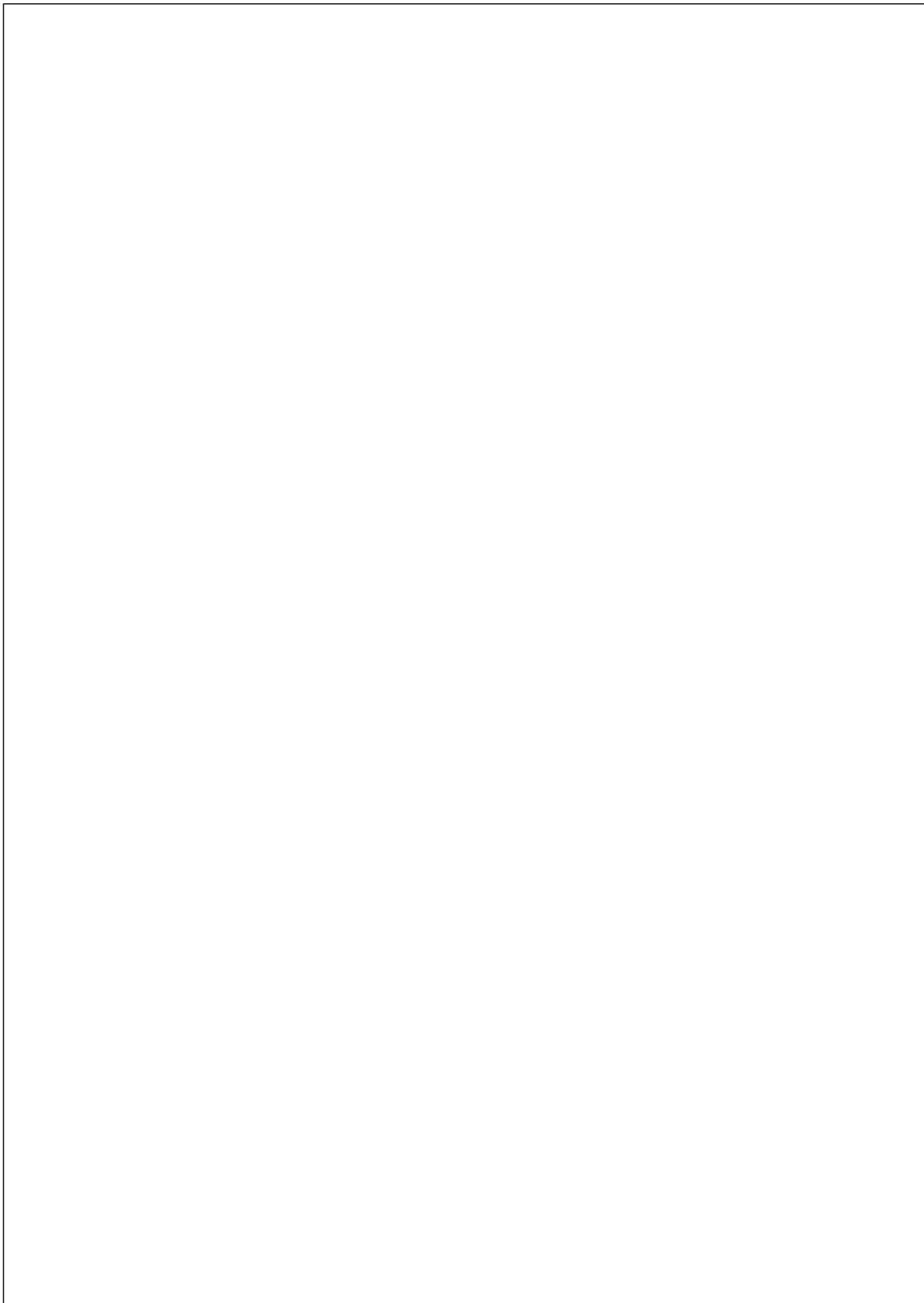

**Physical Dimensions** inches (millimeters) unless otherwise noted

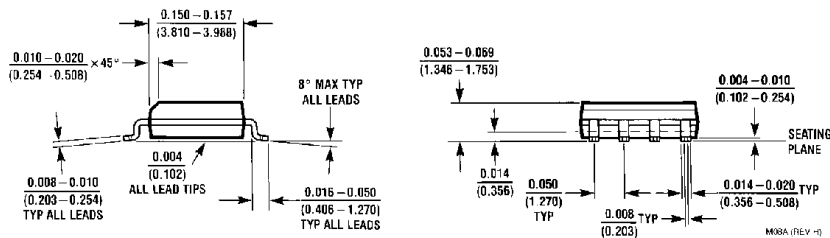
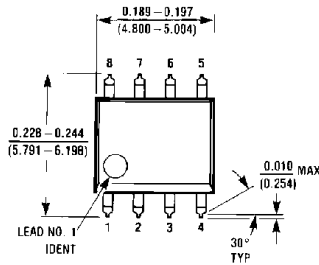

**Molded Small Out-Line Package (M8)**  
**Order Number NM93C13M8 or NM93C14M8**  
**Package Number M08A**

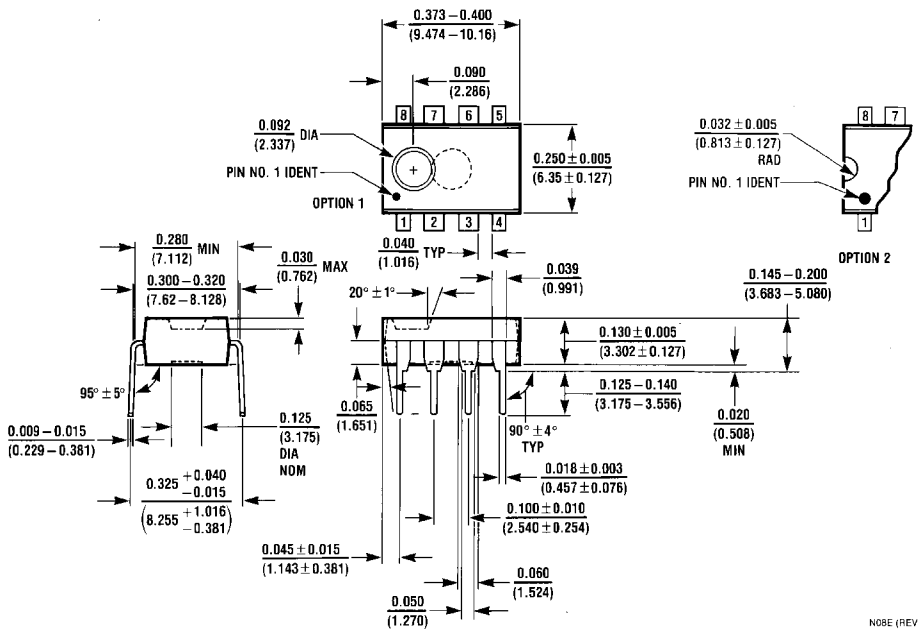

**Molded Dual-In-Line Package (N)**  
**Order Number NM93C13N or NM93C14N**  
**Package Number N08E**

**LIFE SUPPORT POLICY**

FAIRCHILD'S PRODUCTS ARE NOT AUTHORIZED FOR USE AS CRITICAL COMPONENTS IN LIFE SUPPORT DEVICES OR SYSTEMS WITHOUT THE EXPRESS WRITTEN APPROVAL OF THE PRESIDENT OF FAIRCHILD SEMICONDUCTOR CORPORATION. As used herein:

1. Life support devices or systems are devices or systems which, (a) are intended for surgical implant into the body, or (b) support or sustain life, and (c) whose failure to perform when properly used in accordance with instructions for use provided in the labeling, can be reasonably expected to result in a significant injury to the user.
2. A critical component in any component of a life support device or system whose failure to perform can be reasonably expected to cause the failure of the life support device or system, or to affect its safety or effectiveness.

<p><b>Fairchild Corporation</b> Americas Tel: 1-800-272-9959 Fax: 1-800-737-7018 Email: support@nsc.com</p>	<p><b>Fairchild Europe</b> Fax: +49 (0) 1 80-530 85 86 Email: europe.support@nsc.com Deutsch Tel: +49 (0) 1 80-530 85 85 English Tel: +49 (0) 1 80-532 78 32 Français Tel: +49 (0) 1 80-532 93 58 Italiano Tel: +49 (0) 1 80-534 16 80</p>	<p><b>Fairchild Hong Kong Ltd.</b> 13th Floor, Straight Block, Ocean Centre, 5 Canton Rd. Tsimshatsui, Kowloon Hong Kong Tel: (852) 2737-1600 Fax: (852) 2736-9960</p>	<p><b>National Semiconductor Japan Ltd.</b> Tel: 81-3-5620-6175 Fax: 81-3-5620-6179</p>
<p><a href="http://www.fairchildsemi.com">www.fairchildsemi.com</a></p>			

Fairchild does not assume any responsibility for use of any circuitry described, no circuit patent licenses are implied and Fairchild reserves the right at any time without notice to change said circuitry and specifications.