



Chipsmall Limited consists of a professional team with an average of over 10 year of expertise in the distribution of electronic components. Based in Hongkong, we have already established firm and mutual-benefit business relationships with customers from,Europe,America and south Asia,supplying obsolete and hard-to-find components to meet their specific needs.

With the principle of "Quality Parts,Customers Priority,Honest Operation,and Considerate Service",our business mainly focus on the distribution of electronic components. Line cards we deal with include Microchip,ALPS,ROHM,Xilinx,Pulse,ON,Everlight and Freescale. Main products comprise IC,Modules,Potentiometer,IC Socket,Relay,Connector.Our parts cover such applications as commercial,industrial, and automotives areas.

We are looking forward to setting up business relationship with you and hope to provide you with the best service and solution. Let us make a better world for our industry!



## Contact us

Tel: +86-755-8981 8866 Fax: +86-755-8427 6832

Email & Skype: info@chipsmall.com Web: www.chipsmall.com

Address: A1208, Overseas Decoration Building, #122 Zhenhua RD., Futian, Shenzhen, China







# zForce AIR™ Touch Sensor Specifications

2017-12-21

## Legal Notice

Neonode may make changes to specifications and product descriptions at any time, without notice. Do not finalize a design with this information. Neonode assumes no liability for applications assistance or customer product design. Customers are responsible for their products and applications using Neonode components. To minimize the risks associated with customer products and applications, customers should provide adequate design and operating safeguards.

Neonode components are neither designed nor intended for use in FDA Class III applications, or similar life-critical medical equipment. Customers acknowledge and agree that they will not use any Neonode components in FDA Class III applications, or similar life-critical medical equipment, and that Neonode will not be responsible for any failure to meet the requirements of such applications or equipment.

No part of the materials contained in any Neonode document may be copied, photocopied, reproduced, translated or reduced to any electronic medium or machine-readable form, in whole or in part, without specific written permission from Neonode Inc.

NEONODE, the NEONODE logo and ZFORCE are trademarks of Neonode Inc. registered in the United States and other countries. ZFORCE AIR is a trademark of Neonode Inc. All other trademarks are the property of their respective owners.

Copyright © 2017 Neonode Inc. All rights reserved.

# 1 Table of Contents

<b>1</b>	<b>Table of Contents .....</b>	<b>3</b>
<b>2</b>	<b>Introduction .....</b>	<b>5</b>
2.1	Product Overview	5
2.1.1	Main Features	5
2.2	Product Variants	5
2.2.1	Sensor Orientation	6
2.2.2	Sensor Length	6
	Touch Active Area	7
2.3	Basic Principles	9
2.4	Product Integration	9
<b>3</b>	<b>Specifications .....</b>	<b>10</b>
3.1	Specifications Overview	10
3.1.1	Touch Performance Specification	10
3.1.2	Technical Specification	10
3.2	Touch Performance	11
3.2.1	Touch Object Requirement	11
3.2.2	Touch Accuracy	11
	Specification	11
	Definition	11
3.2.3	Response Time	12
	Specification	12
	Definition	12
3.2.4	Scanning Frequency	13
3.3	Power Consumption	14
3.3.1	Specification	14
3.3.2	Definition	14
3.4	Environmental Requirements	15
3.4.1	Operating and Storage Conditions	15
3.4.2	ESD rating	15
3.4.3	Agency Approvals	15
3.5	Electrical Requirements	15
3.5.1	Absolute Maximum Ratings	15
3.5.2	Recommended Operating Conditions	15
3.6	Optical Requirements on External Window	16
3.6.1	Optical Requirements	16
3.6.2	Geometrical Constraints	16
3.7	Mechanical Data	17

3.7.1	Physical Dimensions and Position of Origin	17
	Top View	17
	Side View	19

## 2 Introduction

### 2.1 Product Overview

The zForce AIR Touch Sensor is a laser light based touch sensor that can be integrated and used in various applications. The sensor characteristics are high scanning frequency, low latency, good touch accuracy and the fact that it can be used on any surface or even in mid air. zForce AIR Touch Sensor can be connected to the host system through a standard connector and communicate through a standard I2C or USB interface.

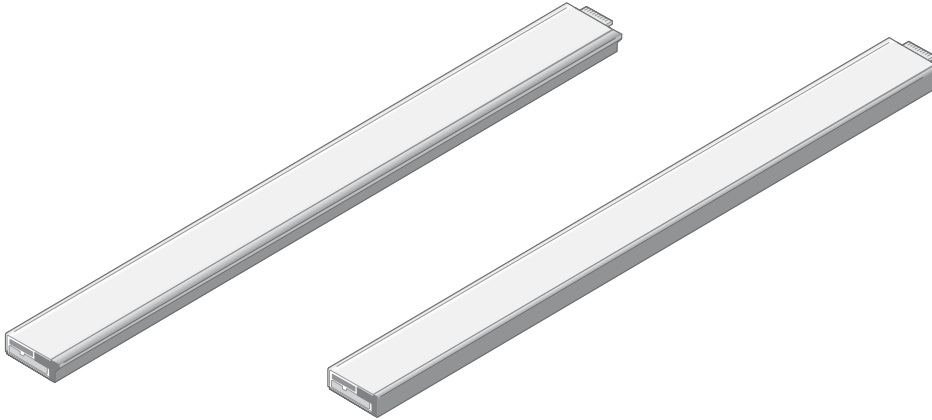

#### 2.1.1 Main Features

- Enables touch on any surface or in mid air
- Dual touch support
- High scanning frequency – up to 200Hz or more depending on sensor length
- Low touch latency
- High touch accuracy
- Idle mode for reduced current power consumption
- Configurable touch active area
- I2C and USB interface
- Standard 5V power supply

### 2.2 Product Variants

In order to fit in a wide range of applications, the zForce AIR Touch Sensor exists in two types and a number of different lengths.



If the variant you are interested in is not available for purchase from your distributor, please contact the distributor or a Neonode sales representative (refer to [www.neonode.com](http://www.neonode.com)<sup>1</sup>) for more information.

---

<sup>1</sup> <http://www.neonode.com/>

### 2.2.1 Sensor Orientation

The zForce AIR Touch Sensor is available in two types, one where the active area emerges straight out from the sensor (0° type) and one where it emerges out from the sensor at a 90° angle (90° type). This enables both vertical and horizontal integration.

#### 0° Type

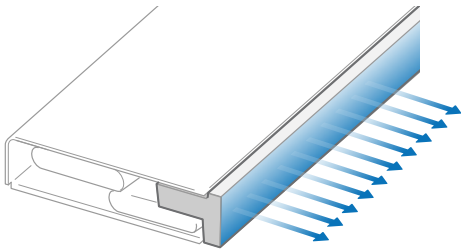

#### 90° Type

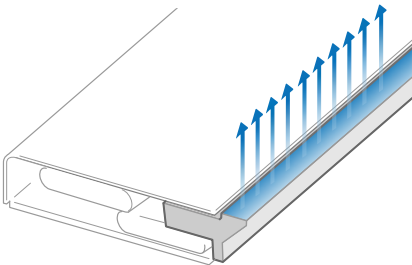

### 2.2.2 Sensor Length

The Touch Sensor is available in 43 different lengths. The length affects the Touch Active Area (TAA) in both X and Y directions.

## Touch Active Area

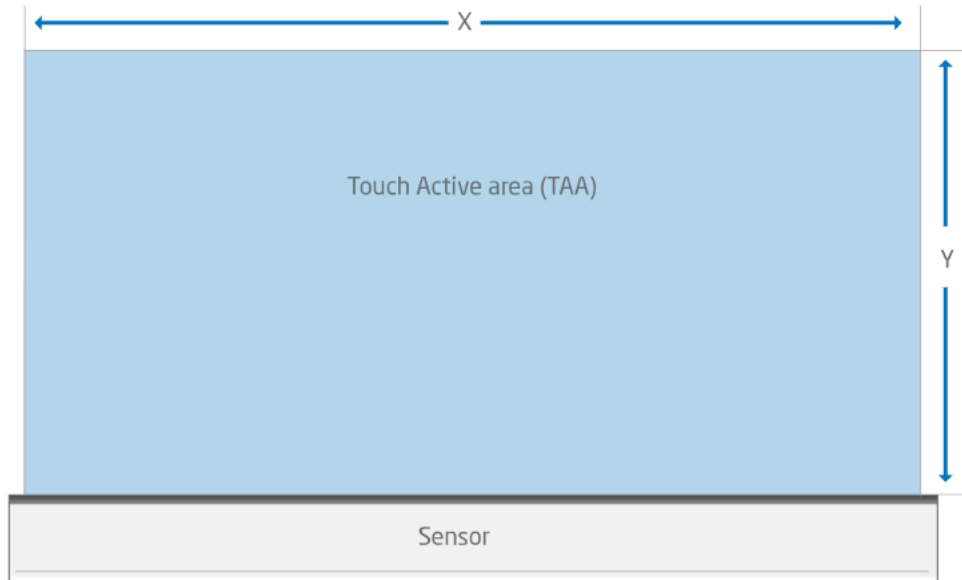

The table lists all product variants, the product number, and the TAA for each variant. See also [Physical Dimensions and Position of Origin](#) (see page 17).

Product number		TAA (mm)	
0° Type	90° Type	X	Y
NNAMC0430PC01	NNAMC0431PC01	43.2	14.9
NNAMC0500PC01	NNAMC0501PC01	50.4	29.8
NNAMC0580PC01	NNAMC0581PC01	57.6	29.8
NNAMC0640PC01	NNAMC0641PC01	64.8	44.7
NNAMC0720PC01	NNAMC0721PC01	72	44.7
NNAMC0790PC01	NNAMC0791PC01	79.2	59.6
NNAMC0860PC01	NNAMC0861PC01	86.4	59.6
NNAMC0940PC01	NNAMC0941PC01	93.6	74.5
NNAMC1010PC01	NNAMC1011PC01	100.8	74.5
NNAMC1080PC01	NNAMC1081PC01	108	89.4
NNAMC1150PC01	NNAMC1151PC01	115.2	89.4



NNAMC1220PC01	NNAMC1221PC01	122.4	104.3
NNAMC1300PC01	NNAMC1301PC01	129.6	104.3
NNAMC1370PC01	NNAMC1371PC01	136.8	119.2
NNAMC1440PC01	NNAMC1441PC01	144	119.2
NNAMC1510PC01	NNAMC1511PC01	151.2	134.0
NNAMC1580PC01	NNAMC1581PC01	158.4	134.0
NNAMC1660PC01	NNAMC1661PC01	165.6	148.9
NNAMC1730PC01	NNAMC1731PC01	172.8	148.9
NNAMC1800PC01	NNAMC1801PC01	180	163.8
NNAMC1870PC01	NNAMC1871PC01	187.2	163.8
NNAMC1940PC01	NNAMC1941PC01	194.4	178.7
NNAMC2020PC01	NNAMC2021PC01	201.6	178.7
NNAMC2090PC01	NNAMC2091PC01	208.8	193.6
NNAMC2160PC01	NNAMC2161PC01	216	193.6
NNAMC2230PC01	NNAMC2231PC01	223.2	208.5
NNAMC2300PC01	NNAMC2301PC01	230.4	208.5
NNAMC2380PC01	NNAMC2381PC01	237.6	208.5
NNAMC2450PC01	NNAMC2451PC01	244.8	208.5
NNAMC2520PC01	NNAMC2521PC01	252	208.5
NNAMC2590PC01	NNAMC2591PC01	259.2	208.5
NNAMC2660PC01	NNAMC2661PC01	266.4	208.5
NNAMC2740PC01	NNAMC2741PC01	273.6	208.5
NNAMC2810PC01	NNAMC2811PC01	280.8	208.5
NNAMC2880PC01	NNAMC2881PC01	288	208.5
NNAMC2950PC01	NNAMC2951PC01	295.2	208.5
NNAMC3020PC01	NNAMC3021PC01	302.4	208.5
NNAMC3100PC01	NNAMC3101PC01	309.6	208.5

NNAMC3170PC01	NNAMC3171PC01	316.8	208.5
NNAMC3240PC01	NNAMC3241PC01	324	208.5
NNAMC3310PC01	NNAMC3311PC01	331.2	208.5
NNAMC3380PC01	NNAMC3381PC01	338.4	208.5
NNAMC3460PC01	NNAMC3461PC01	345.6	208.5

## 2.3 Basic Principles

zForce AIR Touch Sensors detect and trace objects by detecting diffusely reflected infrared light. The sensor comprises an optical system arranged to combine emitted IR beams and receiver fields of view within the same apertures. IR light beams are emitted perpendicular to the output window, while receivers field of view is centered at a certain angle left and right.

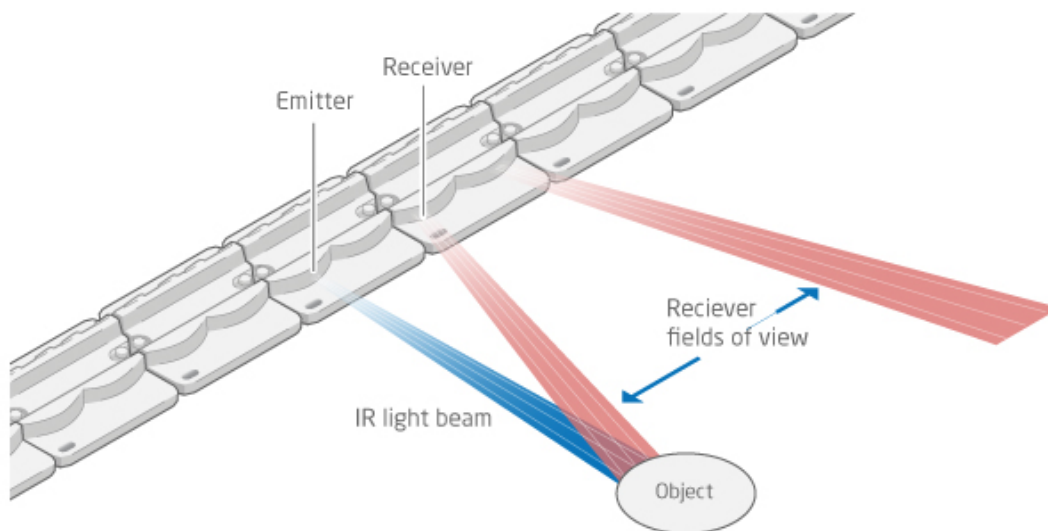

Each emitter-receiver combination covers a narrow region on the active area. An object present in the active area will affect several emitter-receiver channels, and the reported coordinates is the outcome of a center of gravity calculation on these signals.

## 2.4 Product Integration

The zForce AIR Touch Sensor can be integrated to any host system through a physical connector with 8 contact pads with support for both I2C and USB HID. The host system can communicate with the sensor through a communication protocol and an SDK developed by Neocode.

## 3 Specifications

### 3.1 Specifications Overview

#### 3.1.1 Touch Performance Specification

Item	Specification
Input methods	Finger, hand or glove.
Minimum object size (diameter)	5 mm
Number of touch objects	1, 2, or more, depending on application
Touch accuracy	< 5 mm, for sensors $\geq$ 180 mm < 7.5 mm, for sensors < 180 mm
Touch resolution	0.1 mm
Touch activation force	0 N (no activation force required)
Touch Active Area	Up to 345.6 x 208.5 mm. For details, refer to <a href="#">Product Variants</a> (see page 5).
Response time	16-46 ms (initial touch, at 33 Hz in idle mode) 10 ms (continuous tracking, at 100 Hz in active mode)
Scanning frequency	Configurable up to 900 Hz, depending on product variant. For details, refer to <a href="#">Scanning Frequency</a> (see page 13).

#### 3.1.2 Technical Specification

Item	Sensor Variant	Specification
<b>Module size</b> (LxHxW)	0° Type	L x 3.46 x 14.5 mm L depending on product variant.
	90° Type	L x 3.46 x 15.45 mm L depending on product variant.
<b>Power consumption</b> I2C interface Active mode (100 Hz)	72 mm sensor	57 mW
	208.8 mm sensor	80 mW

	345.6 mm sensor	104 mW
<b>Power consumption</b> I2C interface Idle mode (25 Hz)	72 mm sensor	44 mW
	208.8 mm sensor	45 mW
	345.6 mm sensor	47 mW

## 3.2 Touch Performance

### 3.2.1 Touch Object Requirement

zForce AIR Touch Sensors detect and trace objects by detecting diffusely reflected infrared light.

Requirements on the object to detect include:

- A minimum reflectance of 30% in the near IR-spectrum is needed for proper signal levels, that is, the object can not be too dark.
- Object surface must be diffuse. A glossy or mirror-like object may not scatter enough light towards correct receivers in order to generate a reliable detection.
- An object must be  $\geq 5$  mm to ensure sufficient signal levels. This is closely related to reflectance. A white, diffuse object may be smaller than a dark, glossy one.

### 3.2.2 Touch Accuracy

#### Specification

Measured touch coordinate error in X and Y axis is less or equal than the specified value for about 95% of the cases.

Touch coordinate error data is calculated by subtracting the actual position and measured position in X and Y axis.

#### Definition

Touch accuracy is defined statistically through the “Bell curve” describing the normal distribution, and a two-sigma deviation of the data. This means that the touch position reported by the zForce AIR Touch Sensor will deviate less than the specified value in 95% of the cases.

Used "Bell curve" for zForce AIR Touch Sensor statistical analysis is shown below.

### Interpretation of Evaluation Results

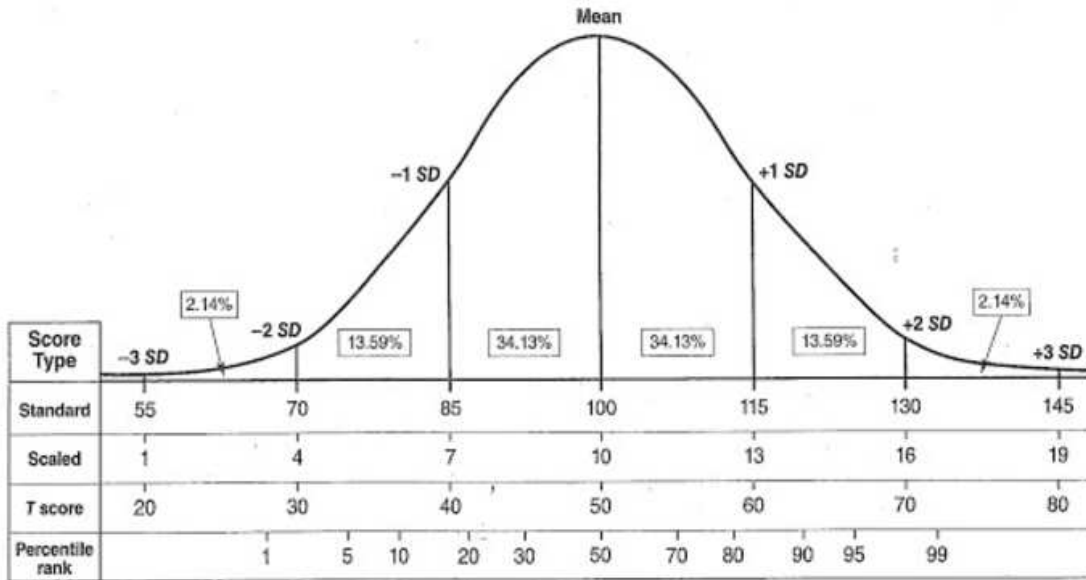

Reference: PAR Psychological Assessment Resources Inc.

#### 3.2.3 Response Time

The specification of response time reflects the reaction speed of a zForce AIR Touch Sensor.

##### Specification

**Initial touch:** 16-46 ms, at 33 Hz scanning frequency (default frequency in idle mode).

**Continuous tracking:** 10 ms, at 100 Hz scanning frequency (default frequency in active mode).

Increasing the scanning frequency decreases the response time.

##### Definition

##### Initial Touch

The specified response time for the **initial touch** starts from the instant an object is presented in the sensor's active area and stops when the sensor starts to send the first touch notification for this object. The specified response time consists of two numbers reflecting the best case and the worst case, with the average response time right in the middle.



The response time (t) can be calculated for different idle mode frequencies (f) can be calculated by the formulas below:

**Best case:**  $t = 16\text{ ms}$

**Worst case:**  $t = 1/f + 16\text{ ms}$

**Average:**  $t = (1/f + 32\text{ ms}) / 2$

In touch applications, an object will be detected slightly before it reaches the touch surface, making the perceived response time shorter.

### Continuous Tracking

After the first touch notification, the sensor will **continuously track** and send touch notifications to update the object position. The response time is therefore defined as the time between subsequent touch notifications.

The response time (t) can be calculated for different active mode frequencies (f) can be calculated by the formula below:

$$t = 1/f$$

### 3.2.4 Scanning Frequency

The scanning frequency can be set using the Neonode API. The default value is 100 Hz in active mode, that is, when an object is detected or tracked. The default value in idle mode, that is, when no object is detected or tracked, is 25 Hz. The maximum scanning frequency depends on the product variant (sensor length). See the chart below.

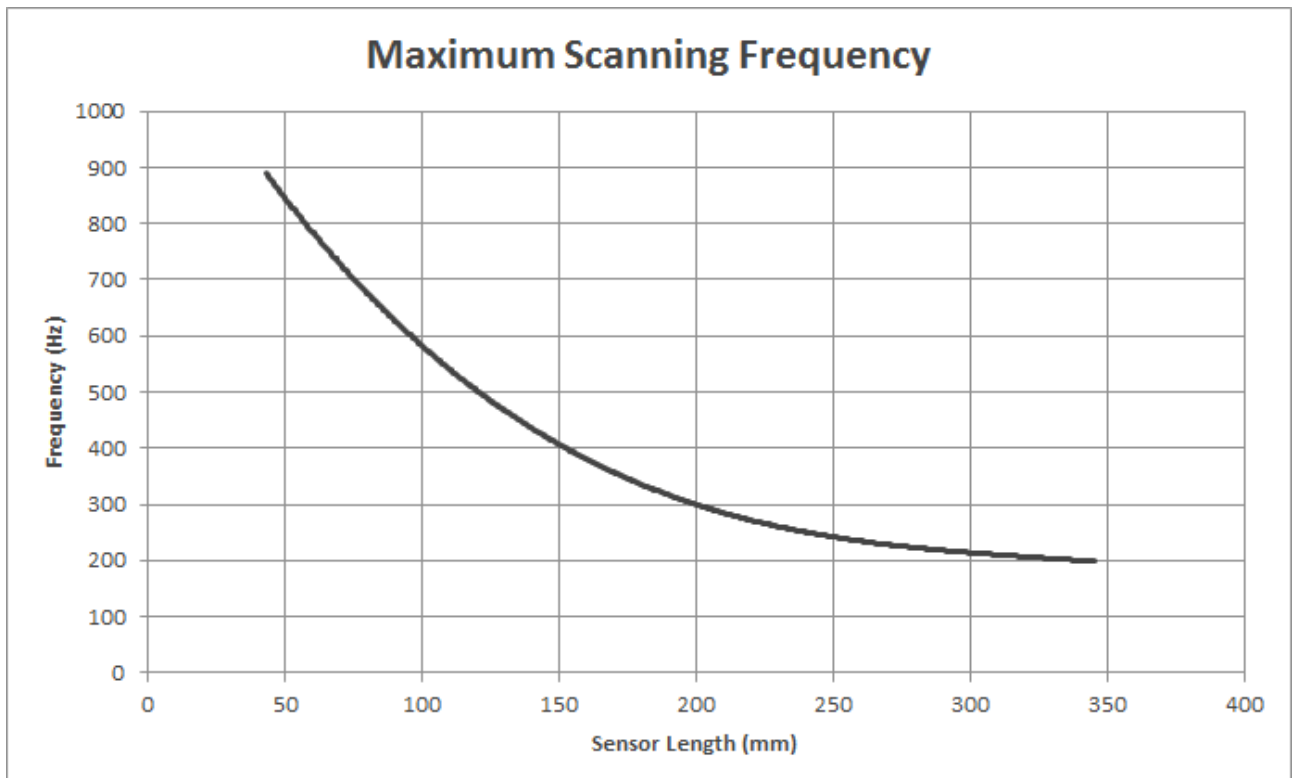

### 3.3 Power Consumption

#### 3.3.1 Specification

The graph below shows the power consumption for various sensor lengths, in active and idle mode. In active mode, the scanning frequency is set to 100 Hz, and one object is presented in active area. In idle mode the scanning frequency is set to 25 Hz, with a clean active area. With higher scanning frequency or more detected objects, the power consumption might slightly higher than the values in the graph. The sensor will only be in active mode when a touch object is being detected or tracked.

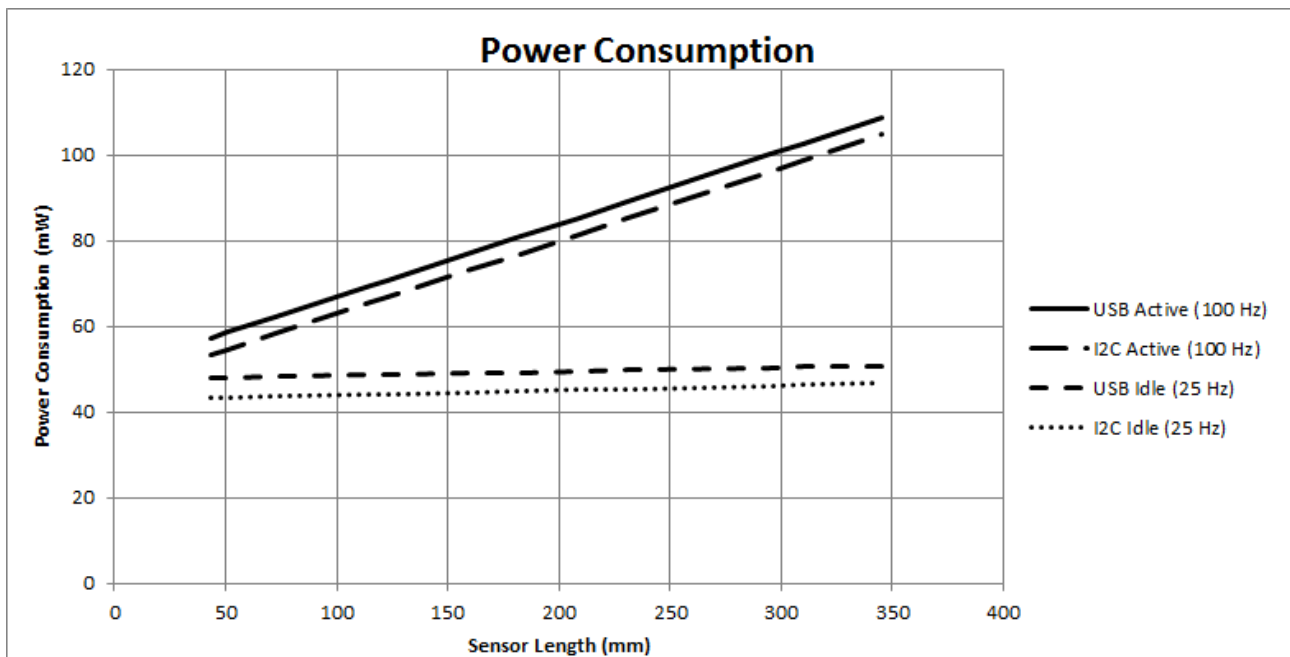

#### 3.3.2 Definition

The power consumption is calculated from the current consumption when supplying the sensor with 5 V.

The current consumption is, in turn, defined as the average current that goes through a sensor. This is measured from the +5V power pin and reflects how much electric energy that is consumed by the whole sensor. In real time, the current is not a stable value. Since the Touch Sensor has a low power consumption design, the processor and some peripheral circuits will switch to sleep mode during the time between two scan periods, to save power. Therefore, the current is frequently changing during run time.

According to the different working modes of the Touch Sensor, the current consumption value also changes between Active mode and Idle mode.

## 3.4 Environmental Requirements

### 3.4.1 Operating and Storage Conditions

Condition	Operation	Storage
Temperature	-20°C to +65°C	-40°C to +85°C
Humidity	5% to 95%	0% to 95%
Altitude	≤5000 m	≤15 km

### 3.4.2 ESD rating

EN55024

(61000-4-2)

Direct contact discharge: 4 kV

Indirect contact discharge: 4 kV

Air discharge: 8 kV

### 3.4.3 Agency Approvals

RoHS, IEC60825-1 Class 1

## 3.5 Electrical Requirements

### 3.5.1 Absolute Maximum Ratings

Parameter	Max Rating	Unit
Supply voltage	-0.3 to 6.0	V
Input voltage on I/O pins	-0.3 to 4	V

### 3.5.2 Recommended Operating Conditions

Parameter	Min	Typ	Max	Unit
Supply voltage	4.75	5.00	5.25	V

## 3.6 Optical Requirements on External Window

Most applications will require an outer cover window, for design cosmetics and protection against dust and humidity.

The optical properties on cover windows placed in front of the sensor are essential in order to maintain a high touch performance. If light is lost, scattered or diverted it will lead to shorter detection range and lower touch accuracy.

### 3.6.1 Optical Requirements

Window material must be optically clear, without absorption and have optical quality surfaces.

- Transmission: **> 88 % at 975nm**
- Haze: **< 3%**
- Surface finish: **SP1-A2 (max Ra 0.05µm).**

Proven plastic materials include optical grade acrylic (PMMA) and polycarbonate. For glass windows, transmission at 975 nm must be verified. Many borosilicate glasses (such as Borofloat) work well, but some common window glasses show substantial absorption due to high iron content.

### 3.6.2 Geometrical Constraints

The zForce AIR Touch Sensor is an optical system that both emits and receives IR-light at different incident angles. When the light hits a transparent material, most of the light is transmitted through the material and exit on the other side. But in reality the amount of light being transmitted is angle dependent, why some shape constraints exist on windows placed in front of the sensor:

- Window surfaces must be parallel.  
A wedge, or lens shaped window will shift light beams out of the active area.
- It is a good practice to install the window at a slight angle ( $\sim 2^\circ$ ) to reduce reflected stray light. See the image below. The angle can be up to approximately  $30^\circ$  without affecting performance.

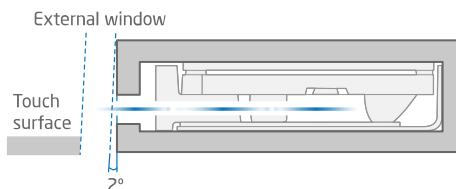

- A slight curvature on the window can be allowed.
- In z-direction, a maximum angle of  $15^\circ$  between window normal and sensors optical axis is recommended.

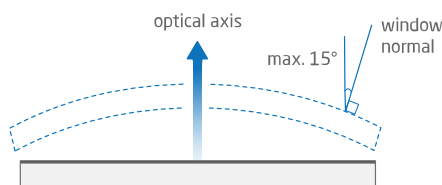

- In x-direction, the angle should be maximum 5°.

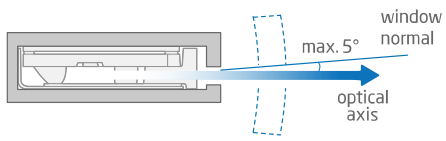

- Keep window thickness as small as mechanically feasible, to reduce absorption losses.

### 3.7 Mechanical Data

#### 3.7.1 Physical Dimensions and Position of Origin

Top View

Dimensions **C** and **D** varies between the Touch Sensor variants and therefore also the Touch Active Area sizes (**A** and **B**).

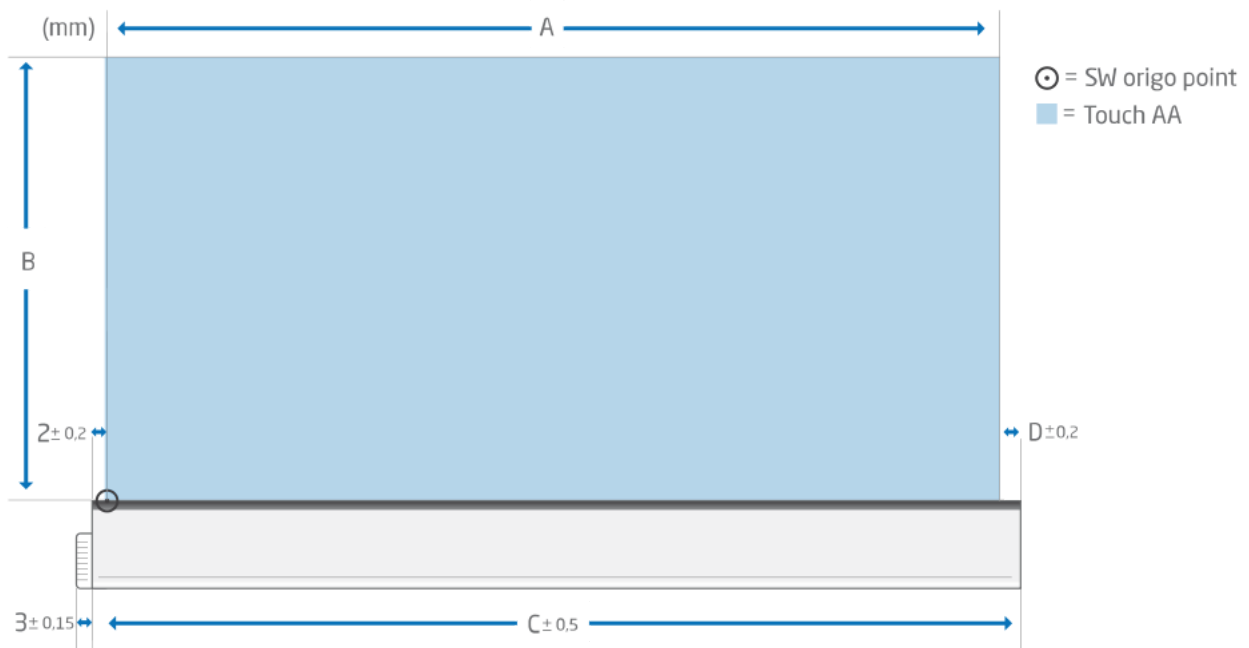

Product number		Measurements (mm)			
0°	90°	A	B	C	D
NNAMC0430PC01	NNAMC0431PC01	43.2	14.9	47.2	2
NNAMC0500PC01	NNAMC0501PC01	50.4	29.8	55.9	3.5



NNAMC0580PC01	NNAMC0581PC01	57.6	29.8	61.6	2
NNAMC0640PC01	NNAMC0641PC01	64.8	44.7	70.3	3.5
NNAMC0720PC01	NNAMC0721PC01	72	44.7	76	2
NNAMC0790PC01	NNAMC0791PC01	79.2	59.6	84.7	3.5
NNAMC0860PC01	NNAMC0861PC01	86.4	59.6	90.4	2
NNAMC0940PC01	NNAMC0941PC01	93.6	74.5	99.1	3.5
NNAMC1010PC01	NNAMC1011PC01	100.8	74.5	104.8	2
NNAMC1080PC01	NNAMC1081PC01	108	89.4	113.5	3.5
NNAMC1150PC01	NNAMC1151PC01	115.2	89.4	119.2	2
NNAMC1220PC01	NNAMC1221PC01	122.4	104.3	127.9	3.5
NNAMC1300PC01	NNAMC1301PC01	129.6	104.3	133.6	2
NNAMC1370PC01	NNAMC1371PC01	136.8	119.2	142.3	3.5
NNAMC1440PC01	NNAMC1441PC01	144	119.2	148	2
NNAMC1510PC01	NNAMC1511PC01	151.2	134.0	156.7	3.5
NNAMC1580PC01	NNAMC1581PC01	158.4	134.0	162.4	2
NNAMC1660PC01	NNAMC1661PC01	165.6	148.9	171.1	3.5
NNAMC1730PC01	NNAMC1731PC01	172.8	148.9	176.8	2
NNAMC1800PC01	NNAMC1801PC01	180	163.8	185.5	3.5
NNAMC1870PC01	NNAMC1871PC01	187.2	163.8	191.2	2
NNAMC1940PC01	NNAMC1941PC01	194.4	178.7	199.9	3.5
NNAMC2020PC01	NNAMC2021PC01	201.6	178.7	205.6	2
NNAMC2090PC01	NNAMC2091PC01	208.8	193.6	214.3	3.5
NNAMC2160PC01	NNAMC2161PC01	216	193.6	220	2
NNAMC2230PC01	NNAMC2231PC01	223.2	208.5	228.7	3.5
NNAMC2300PC01	NNAMC2301PC01	230.4	208.5	234.4	2
NNAMC2380PC01	NNAMC2381PC01	237.6	208.5	243.1	3.5
NNAMC2450PC01	NNAMC2451PC01	244.8	208.5	248.8	2

NNAMC2520PC01	NNAMC2521PC01	252	208.5	257.5	3.5
NNAMC2590PC01	NNAMC2591PC01	259.2	208.5	263.2	2
NNAMC2660PC01	NNAMC2661PC01	266.4	208.5	271.9	3.5
NNAMC2740PC01	NNAMC2741PC01	273.6	208.5	277.6	2
NNAMC2810PC01	NNAMC2811PC01	280.8	208.5	286.3	3.5
NNAMC2880PC01	NNAMC2881PC01	288	208.5	292	2
NNAMC2950PC01	NNAMC2951PC01	295.2	208.5	300.7	3.5
NNAMC3020PC01	NNAMC3021PC01	302.4	208.5	306.4	2
NNAMC3100PC01	NNAMC3101PC01	309.6	208.5	315.1	3.5
NNAMC3170PC01	NNAMC3171PC01	316.8	208.5	320.8	2
NNAMC3240PC01	NNAMC3241PC01	324	208.5	329.5	3.5
NNAMC3310PC01	NNAMC3311PC01	331.2	208.5	335.2	2
NNAMC3380PC01	NNAMC3381PC01	338.4	208.5	343.9	3.5
NNAMC3460PC01	NNAMC3461PC01	345.6	208.5	349.6	2

Side View

These measurements are identical for all sensor lengths but varies some between the 0° and 90 ° types. The position of origin is marked with "zero software".

0° Type

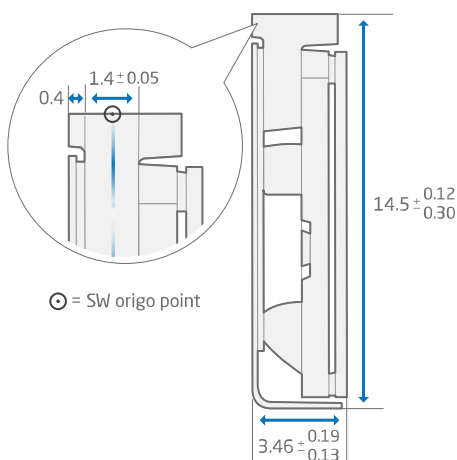

90 ° Type

