



Chipsmall Limited consists of a professional team with an average of over 10 year of expertise in the distribution of electronic components. Based in Hongkong, we have already established firm and mutual-benefit business relationships with customers from,Europe,America and south Asia,supplying obsolete and hard-to-find components to meet their specific needs.

With the principle of “Quality Parts,Customers Priority,Honest Operation,and Considerate Service”,our business mainly focus on the distribution of electronic components. Line cards we deal with include Microchip,ALPS,ROHM,Xilinx,Pulse,ON,Everlight and Freescale. Main products comprise IC,Modules,Potentiometer,IC Socket,Relay,Connector.Our parts cover such applications as commercial,industrial, and automotives areas.

We are looking forward to setting up business relationship with you and hope to provide you with the best service and solution. Let us make a better world for our industry!



## Contact us

Tel: +86-755-8981 8866 Fax: +86-755-8427 6832

Email & Skype: info@chipsmall.com Web: www.chipsmall.com

Address: A1208, Overseas Decoration Building, #122 Zhenhua RD., Futian, Shenzhen, China





**FEATURES**

- RoHS compliant
- High efficiency to 89%
- Power density up to 1.78W/cm<sup>3</sup>
- UL94 V-0 package material
- Industry standard pinout
- UL 1950 recognized
- Non latching current limit
- Constant 350kHz frequency
- 1.5kV input to output isolation
- Versatile control options
- Continuous rating to 30W at 60°C without heatsink
- Operation to zero load
- Protected against load faults
- Internal over temperature protection
- Uses no electrolytic capacitors

**DESCRIPTION**

The NPH25S series of DC/DC converters combines ease of application with versatility. The pin pattern is based on the popular industry standard, but two additional pins may optionally be fitted to provide a variety of features not commonly found on units of this type. High efficiency enables full rating to be achieved in a small package without heat-sinking, and a high surge capability will provide for start-up and transient loads, whilst being thermally protected against sustained overload. Overload protection of the “constant current” type ensures start-up into complex load conditions. The copper case achieves efficient heat transfer and screening. The product range has been recognised by Underwriters Laboratory (UL) to UL 1950 for operational insulation, file number E151252 applies.



**SELECTION GUIDE**

Order Code <sup>1</sup>	Nominal Input Voltage	Output Voltage	Output Current	Current Limit		Efficiency	MTTF <sup>2</sup>	Recommended Alternative
	V	V	A	A (Min.)	A (Max.)	%	kHrs	
NPH25S2403EiC	24	3.4	7.3	7.5	11.0	81	334	UEI30-033-Q48N-C
NPH25S2403iC	24	3.4	7.3	7.5	11.0	81	334	UEI30-033-Q48N-C
NPH25S2405EiC	24	5.1	5.0	5.0	7.5	84	290	UEI30-050-Q48N-C
NPH25S2405iC	24	5.1	5.0	5.0	7.5	84	290	UEI30-050-Q48N-C
NPH25S2412EiC	24	12.1	2.1	2.5	3.7	86	291	UEI30-120-Q48N-C
NPH25S2412iC	24	12.1	2.1	2.5	3.7	86	291	UEI30-120-Q48N-C
NPH25S2415EiC	24	15.1	1.7	2.0	3.0	87	290	UEI30-150-Q48N-C
NPH25S2415iC	24	15.1	1.7	2.0	3.0	87	290	UEI30-150-Q48N-C
<b>Obsolete</b>								
NPH25S4803EiC	48	3.4	7.3	7.5	11.0	83	369	UEI25-033-D48P-C
NPH25S4803iC	48	3.4	7.3	7.5	11.0	83	369	UEI25-033-D48P-C
NPH25S4805EiC	48	5.1	5.0	5.0	7.5	85	366	UEI25-050-D48P-C
NPH25S4805iC	48	5.1	5.0	5.0	7.5	85	366	UEI25-050-D48P-C
NPH25S4812EiC	48	12.1	2.1	2.5	3.7	88	368	UEI25-120-D48P-C
NPH25S4812iC	48	12.1	2.1	2.5	3.7	88	368	UEI25-120-D48P-C
NPH25S4815EiC	48	15.1	1.7	2.0	3.0	89	366	Contact Murata
NPH25S4815iC	48	15.1	1.7	2.0	3.0	89	366	Contact Murata

**INPUT CHARACTERISTICS**

Parameter	Conditions	Min.	Typ.	Max.	Units
Voltage range	Continuous operation, 24V input types	18	24	36	V
	Continuous operation, 48V input types	36	48	75	

**OUTPUT CHARACTERISTICS**

Parameter	Conditions	Min.	Typ.	Max.	Units
Voltage set point error	50% load			0.5	%
Overall voltage error	Case temperature -40°C to 110°C Load 0% - 100%, Input specified range			2.5	%
Temperature coefficient of output voltage (slope)				250	ppm°C
Deviation of output voltage	Temperature MIN-MAX		0.5	1	%
Line regulation	Operating voltage range, 50% load			0.1	%
Load Regulation	0% - 100% rated load			0.5	%
Ripple	rms		70		mV

**ISOLATION CHARACTERISTICS**

Parameter	Conditions	Min.	Typ.	Max.	Units
Isolation test voltage	Flash tested for 1 second	1500			VDC
Resistance	VISO = 500VDC	1			GΩ

**ABSOLUTE MAXIMUM RATINGS**

Input voltage, 24V input types	-0.5V to 40V <sup>3</sup>
Input voltage, 48V input types	-0.5V to 80V <sup>3</sup>
Output voltage	-0.3V to regulated voltage
Output trim control	-1V to +30V
Synchronisation/shutdown control	±15V relative to input return

1. Parts ending with EiC have optional TRIM and SS pins fitted.
2. Calculated using MIL-HDBK-217F with nominal input voltage at full load.
3. Absolute maximum value for 30 seconds. Prolonged operation may damage the product.  
All specifications typical at T<sub>a</sub>=25°C, nominal input voltage and rated output current unless otherwise specified.



### CONTROL CHARACTERISTICS

Parameter	Conditions	Min.	Typ.	Max.	Units
Voltage trimming range <sup>1</sup>	At rated load, trim control at either output	±10			%
Remote switch input (voltage relative to input negative) <sup>1</sup>	Not operating	-15	0	1.5	V
	Operating, open circuit voltage	9	10	11	
Start delay	Time from application of valid input voltage to output being in specification		25	50	ms
Synchronisation <sup>1</sup>	Specified drive signal	320		440	kHz
Switching frequency		330	350	395	

### TEMPERATURE CHARACTERISTICS

Parameter	Conditions	Min.	Typ.	Max.	Units
Case temperature	Full load	-40		110	°C
Storage	Absolute Max. internal temperature	-40		125	
Relative humidity	Non condensing 85°C			85	%
Thermal protection	Operates at case temperature	110			°C

### THERMAL CHARACTERISTICS

**UL 1950 recognition:** Max. permissible loads for a given ambient temperature for any NPH25S model.

Temperature (°C)	Power (W)	Temperature (°C)	Power (W)
40	25.0	80	13.9
50	22.2	85	12.5
60	19.4	90	11.1
70	16.6		

Max. power rating with case temperature maintained by external means (e.g. forced air cooling).

Part Number	Case Temperature			Units
	100°C	105°C	110°C	
NPH25S2403XXX	24	20	15	W
NPH25S2405XXX	25	22	18	
NPH25S2412XXX	30	24	21	
NPH25S2415XXX	30	27	22	
NPH25S4803XXX	25	20	16	W
NPH25S4805XXX	25	24	20	
NPH25S4812XXX	30	29	24	
NPH25S4815XXX	30	30	26	

### THERMAL PERFORMANCE

24V Input

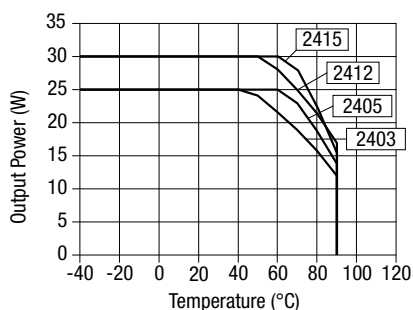

48V Input

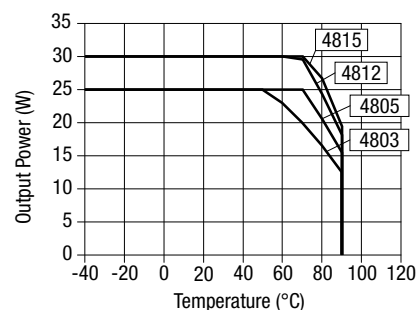

1. Optional - where fitted.

**APPLICATION NOTES**

**OUTPUT VOLTAGE ADJUSTMENT**

The trim resistor equations are:

$$R_{up} = (R/V_{up}) - S \text{ k}\Omega$$

$$R_{down} = (L \times \frac{T}{V_{down}}) - T - S \text{ k}\Omega$$

V <sub>NOM</sub>	3.4	5.1	12.1	15.1
S	22.2973	20.59761	28.79096	39.95902
T	10.1351	9.36255	15.42373	20.77869
R	17.9994	24.49487	94.9661	147.7314
L	-1.6241	-2.48374	-5.942857	-7.990244

**TRIM UP**

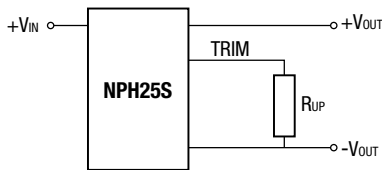

**TRIM DOWN**

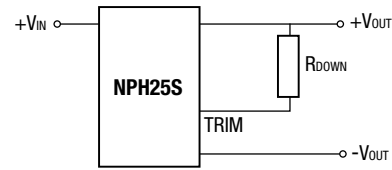

When the output voltage is trimmed up, output current must be derated so that the maximum output power is not exceeded.

Example to decrease output voltage of NPH25S4805EiC by 0.1V:

$$R_{DOWN} = \left( \frac{-2.48374 \times 9.36255}{-0.1} \right) - 9.36255 - 20.59761 = 203.18\text{k}\Omega$$

**SET VOLTAGE**

The output voltage of all units is set to 100mV above nominal, to offset resistive losses and thus assist with worst case error calculations. For the EiC versions, this allowance can be altered with a single fixed resistor, connected from the trimming pin to one of the output pins.

**SHUTDOWN**

When the shutdown pin (SS) is shorted to the negative input, the converter will stop. Its current consumption will then be less than 1mA at nominal supply voltage. The voltage must be less than 1.5V to ensure that the unit stops, and must be able to sink at least 1mA.

The unit will restart if the control pin is left open circuit or raised to a value close to its normal open circuit voltage. This is typically 10V. Note however, that the unit will not meet specification while a significant current drain from this pin remains.

If the shutdown pin is to be connected to a long wire, it is recommended that a capacitor decouples the pin to the supply common in order to avoid the risk of injecting noise into the converter circuit. A series resistor may also be helpful. Values of 10nF and 1kΩ may be used.

Many NPH series converters may be switched together simply by linking the primary control pins. The primary common pins must also be linked.

**FREQUENCY CONTROL**

If the primary side dc control voltage is pulled away from its open circuit voltage, the converter frequency will be changed, approximately in proportion to the voltage. With +8.5VDC voltage to SS pin, the typical switching frequency will be 300kHz. If this is raised to 15VDC, the switching frequency will typically be 510kHz. The frequency may thus be moved away from a sensitive value or into a safe area. Deviation of at least -10% to +30% is achievable, though the efficiency will decline with significant changes. Also note that if the frequency is lowered, the switching frequency component of output ripple will increase. Since the design uses no large electrolytic capacitors, any use of a lower frequency must allow for the effects of increased ripple. Additional external filtering may be required.

**APPLICATION NOTES (continued)**

**SYNCHRONIZATION**

The converter frequency may be synchronised to an external frequency by connecting a negative going pulse to the SS pin. The drive signal is typically 8V to 12V amplitude and 100ns to 200ns duration. A suitable circuit consists of a CMOS timer (TLC555) connected as an oscillator or as a pulse shaper. Its logic output (not the discharge output) should be connected via a 4.7nF capacitor to the converter pin. The synchronised frequency is above the free running value. However, the free running frequency can be lowered, so that synchronisation may include frequencies near or below the natural value. An example of a practical circuit is shown below, which uses a zener diode to lower the natural frequency. Several converters of this family may be synchronised from the same reference provided the waveform can be maintained by the use of an adequate driver circuit. If the rise time is more than 20ns, for example, synchronisation may not be achieved over the specified frequency range.

For best efficiency, set the frequency within the specified range of its natural state.

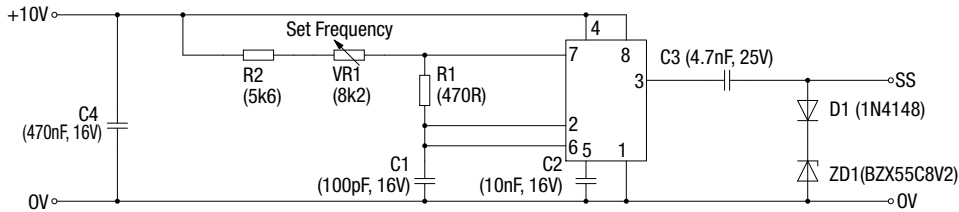

**TECHNICAL NOTES**

**ISOLATION VOLTAGE**

'Hi Pot Test', 'Flash Tested', 'Withstand Voltage', 'Proof Voltage', 'Dielectric Withstand Voltage' & 'Isolation Test Voltage' are all terms that relate to the same thing, a test voltage, applied for a specified time, across a component designed to provide electrical isolation, to verify the integrity of that isolation.

Murata Power Solutions NPH25S series of DC/DC converters are all 100% production tested at their stated isolation voltage. This is 1500 VDC for 1 second.

A question commonly asked is, "What is the continuous voltage that can be applied across the part in normal operation?"

The NPH25S series has been recognized by Underwriters Laboratory, both input and output should normally be maintained within SELV limits i.e. less than 42.4V peak, or 60VDC. The isolation test voltage represents a measure of immunity to transient voltages and the part should never be used as an element of a safety isolation system. The part could be expected to function correctly with several hundred volts offset applied continuously across the isolation barrier; but then the circuitry on both sides of the barrier must be regarded as operating at an unsafe voltage and further isolation/insulation systems must form a barrier between these circuits and any user-accessible circuitry according to safety standard requirements.

**REPEATED HIGH-VOLTAGE ISOLATION TESTING**

It is well known that repeated high-voltage isolation testing of a barrier component can actually degrade isolation capability, to a lesser or greater degree depending on materials, construction and environment. While manufactured parts can withstand several times the stated test voltage, the isolation capability does depend on the wire insulation. Any material, including this enamel (typically polyurethane) is susceptible to eventual chemical degradation when subject to very high applied voltages thus implying that the number of tests should be strictly limited. We therefore strongly advise against repeated high voltage isolation testing, but if it is absolutely required, that the voltage be reduced by 20% from specified test voltage.

**EMC FILTERING AND SPECTRA**

**FILTERING**

The module includes a basic level of filtering, sufficient for many applications. Where lower noise levels are desired, filters can easily be added to achieve any required noise performance.

A DC/DC converter generates noise in two principle forms: that which is radiated from its body and that conducted on its external connections. There are three separate modes of conducted noise: input differential, output differential and input-output.

This last appears as common mode at the input and the output, and cannot therefore be removed by filtering at the input or output alone. The first level of filtering is to connect a capacitor between input and output returns, to reduce this form of noise. It typically contains high harmonics of the switching frequency, which tend to appear as spikes on surrounding circuits. The voltage rating of this capacitor must match the required isolation voltage. (Due to the great variety in isolation voltage and required noise performance, this capacitor has not been included within the converter.)

Input ripple is a voltage developed across the internal Input decoupling capacitor. It is therefore measured with a defined supply source impedance. Although simple series inductance will provide filtering, on its own it can degrade the stability. A shunt capacitor is therefore recommended across the converter input terminals, so that it is fed from a low impedance.

If no filtering is required, the inductance of long supply wiring could also cause a problem, requiring an input decoupling capacitor for stability. An electrolytic will perform well in these situations. The input-output filtering is performed by the common-mode choke on the primary. This could be placed on the output, but would then degrade the regulation and produce less benefit for a given size, cost, and power loss.

Radiated noise is present in magnetic and electrostatic forms. The latter is suppressed by the metal case, which is connected to the output return, typically a zero-volt point. Thanks to the small size of these units, neither form of noise will be radiated "efficiently", so will not normally cause a problem. Any question of this kind usually better repays attention to conducted signals.

**EMC FILTER AND VALUES TO OBTAIN SPECTRA AS SHOWN**

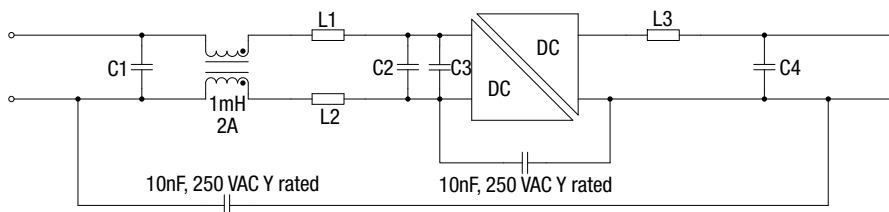

**Component reference**

	C1	C2	C3	C4	L1	L2	L3
NPH25S2403	10µF 100V	2.2µF 63V	47µF 63V	10µF 25V		MPS 18R333C 33µH 2A	4.7µH
NPH25S2405	10µF 100V	2.2µF 63V	47µF 63V	10µF 25V		MPS 18R333C 33µH 2A	10µH
NPH25S2412	10µF 100V	2.2µF 63V	Not required	10µF 25V		MPS 18R333C 33µH 2A	MPS 49330C 33µH 2.5A
NPH25S2415	10µF 100V	2.2µF 63V	47µF 63V	10µF 25V		MPS 18R333C 33µH 2A	MPS 18R333C 33µH 2.00A
NPH25S4803	10µF 100V	Not required	Not required	10µF 25V		MPS 18R104C 100µH 1.2A	4.7µH
NPH25S4805	10µF 100V	Not required	Not required	10µF 25V		MPS 18R104C 100µH 1.2A	10µH
NPH25S4812	10µF 100V	Not required	Not required	10µF 25V		MPS 18R104C 100µH 1.2A	MPS 49330C 33µH 2.5A
NPH25S4815	10µF 100V	Not required	Not required	10µF 25V		MPS 18R104C 100µH 1.2A	MPS 18R333C 33µH 2.00A

C1, C2 & C4 : Electrolytic capacitors

C3 : Polyester or ceramic capacitor

EMC Spectra red limit line is EN 55022 curve B Quasi-peak average limit.

**EMC FILTERING AND SPECTRA (continued)**

**NPH25S2403**

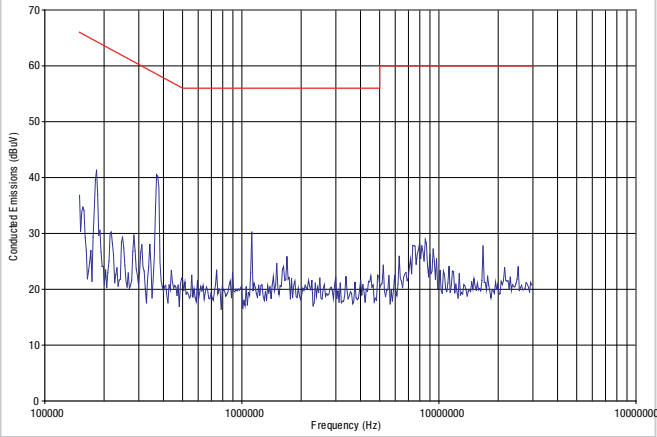

**NPH25S2405**

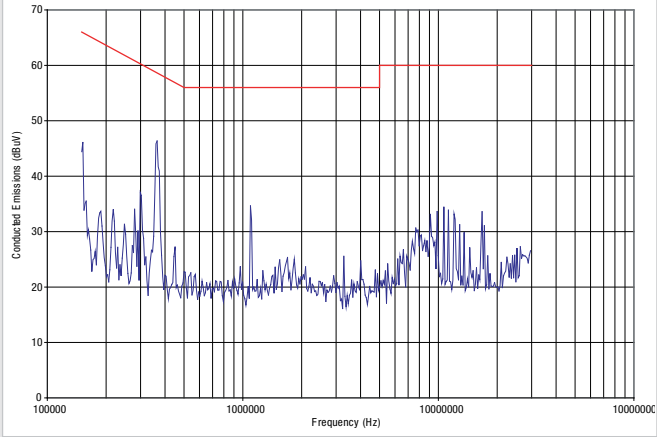

**NPH25S2412**

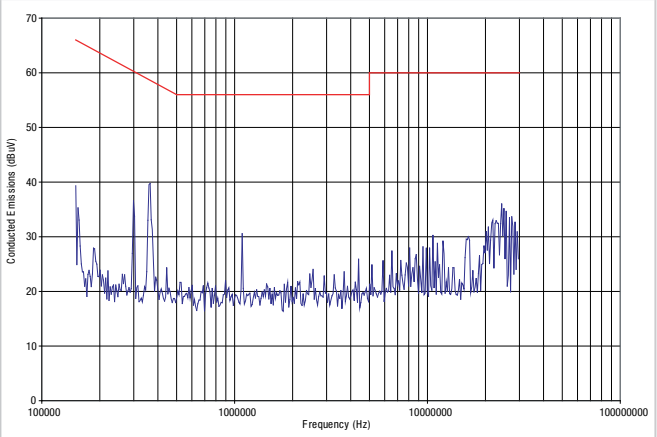

**NPH25S2415**

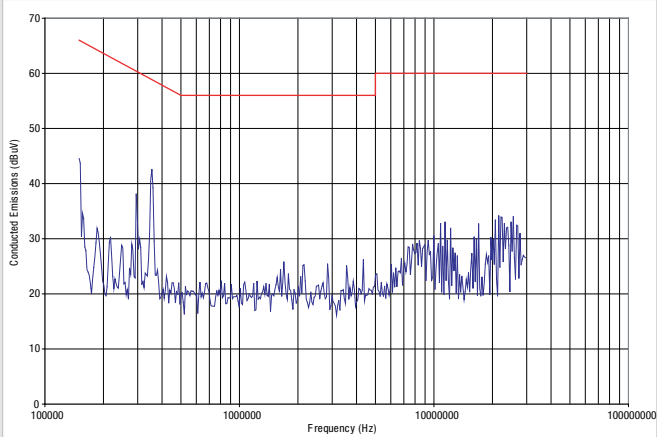

**NPH25S4803**

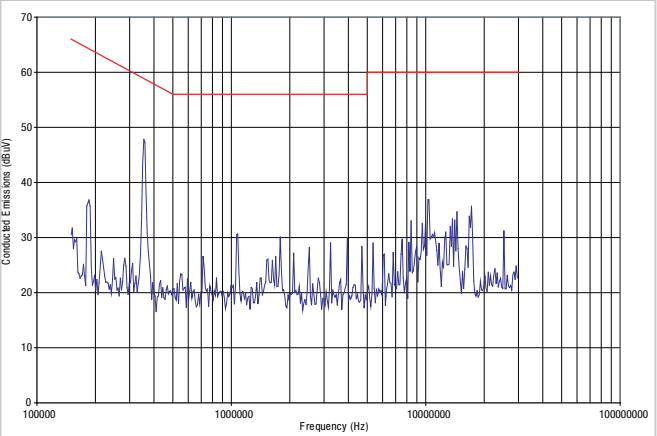

**NPH25S4805**

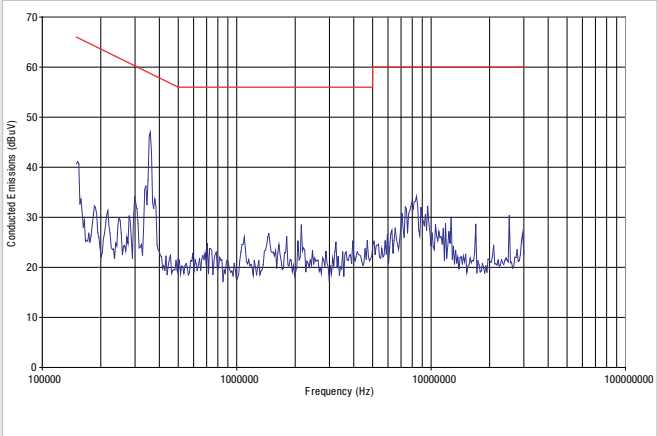

**EMC FILTERING AND SPECTRA (continued)**

**NPH25S4812**

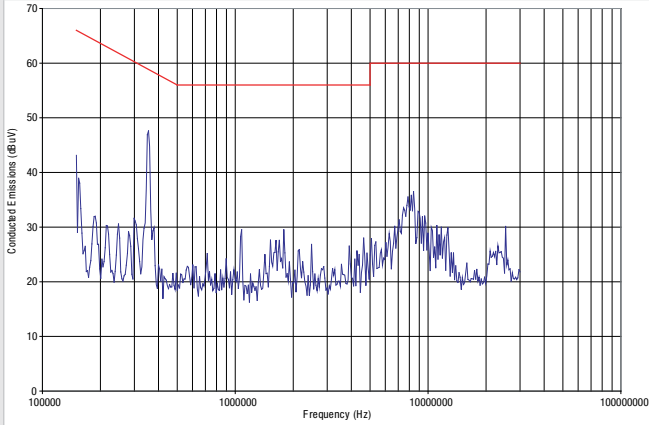

**NPH25S4815**

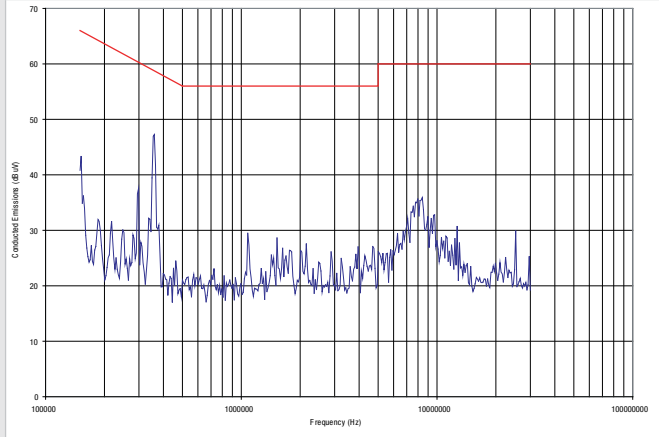

**RoHS COMPLIANCE INFORMATION**



This series is compatible with RoHS soldering systems with a peak wave solder temperature of 260°C for 10 seconds. The pin termination finish on this product series is a Gold flash (0.05-0.10 micron) over Nickel Preplate. The series is backward compatible with Sn/Pb soldering systems. For further information, please visit [www.murata-ps.com/rohs](http://www.murata-ps.com/rohs)



### PACKAGE SPECIFICATIONS

#### MECHANICAL DIMENSIONS

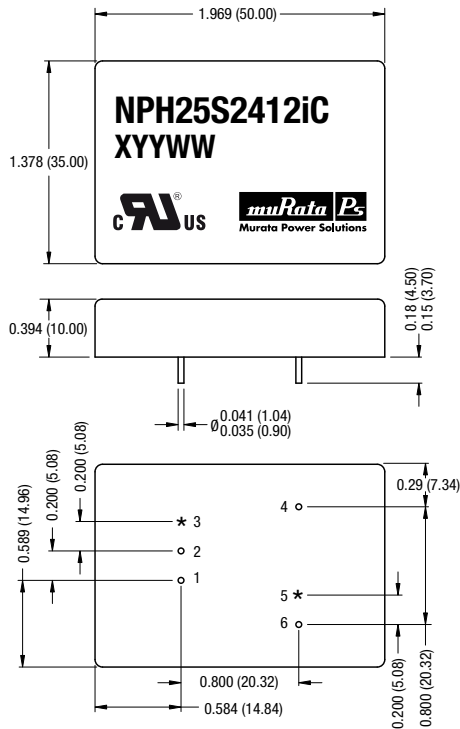

Weight: 45g

All dimensions in inches  $\pm 0.01$  (mm  $\pm 0.25$ mm)

All pins on a 0.10 (2.54) pitch and within  $\pm 0.01$  (0.254) of true position

\* Optional control pins

The copper case is internally connected to the output (-V<sub>OUT</sub>) pin. Care is needed in the design of this circuit board on which the converter is mounted. Top side tracks must not contact the edge of the case on the underside of the unit.

Please note that from 2010 onwards you may receive either a blue or a black case finish.

#### PIN CONNECTIONS

Pin	Function
1	-V <sub>IN</sub>
2	+V <sub>IN</sub>
3*	SS
4	+V <sub>OUT</sub>
5*	TRIM
6	-V <sub>OUT</sub>

\* Optional pins

#### RECOMMENDED FOOTPRINT DETAILS

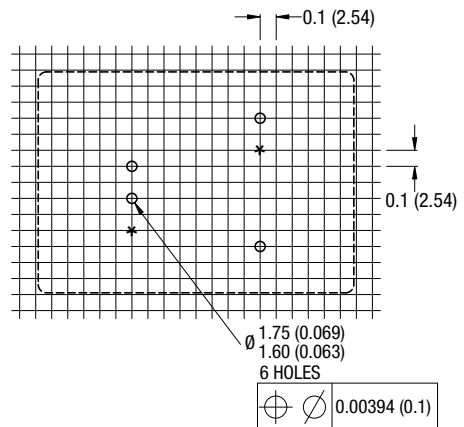

All dimensions in inches  $\pm 0.01$  (mm  $\pm 0.25$ mm)

\* Optional control pins

#### TUBE OUTLINE DIMENSIONS

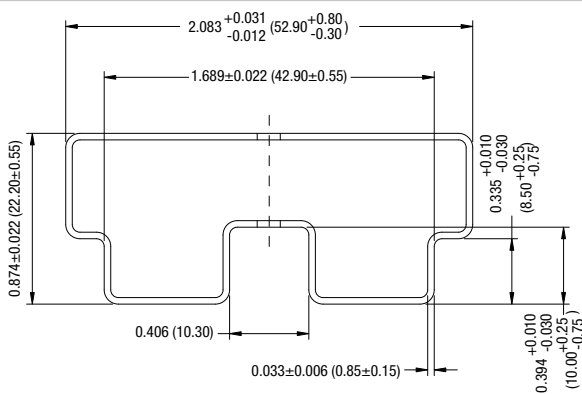

All dimensions in inches  $\pm 0.01$  (mm  $\pm 0.25$ mm)

Tube length: 530 (20.866)  $\pm 2$  (0.079)

Tube material: Antistatic coated clear PVC

Tube Quantity: 15

Murata Power Solutions, Inc.  
11 Cabot Boulevard, Mansfield, MA 02048-1151 U.S.A.  
ISO 9001 and 14001 REGISTERED



This product is subject to the following **operating requirements** and the **Life and Safety Critical Application Sales Policy**:

Refer to: <http://www.murata-ps.com/requirements/>

Murata Power Solutions, Inc. makes no representation that the use of its products in the circuits described herein, or the use of other technical information contained herein, will not infringe upon existing or future patent rights. The descriptions contained herein do not imply the granting of licenses to make, use, or sell equipment constructed in accordance therewith. Specifications are subject to change without notice.

© 2013 Murata Power Solutions, Inc.