



Chipsmall Limited consists of a professional team with an average of over 10 year of expertise in the distribution of electronic components. Based in Hongkong, we have already established firm and mutual-benefit business relationships with customers from,Europe,America and south Asia,supplying obsolete and hard-to-find components to meet their specific needs.

With the principle of “Quality Parts,Customers Priority,Honest Operation,and Considerate Service”,our business mainly focus on the distribution of electronic components. Line cards we deal with include Microchip,ALPS,ROHM,Xilinx,Pulse,ON,Everlight and Freescale. Main products comprise IC,Modules,Potentiometer,IC Socket,Relay,Connector.Our parts cover such applications as commercial,industrial, and automotives areas.

We are looking forward to setting up business relationship with you and hope to provide you with the best service and solution. Let us make a better world for our industry!



Contact us

Tel: +86-755-8981 8866 Fax: +86-755-8427 6832

Email & Skype: info@chipsmall.com Web: www.chipsmall.com

Address: A1208, Overseas Decoration Building, #122 Zhenhua RD., Futian, Shenzhen, China



NQR002A0X4: Non-Isolated DC-DC Power Modules

3Vdc –14Vdc input; 0.6Vdc to 5.5Vdc output; 2A Output Current



RoHS Compliant

Applications

- Distributed power architectures
- Intermediate bus voltage applications
- Telecommunications equipment
- Servers and storage applications
- Networking equipment
- Industrial applications

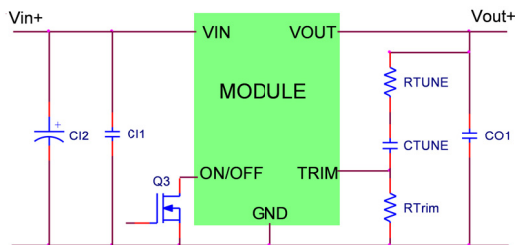

Features

- Compliant to RoHS EU Directive 2002/95/EC (Z versions)
- Compatible in a Pb-free or SnPb wave-soldering environment (Z versions)
- Wide Input voltage range (3Vdc-14Vdc)
- Output voltage programmable from 0.6 Vdc to 5.5Vdc via external resistor
- Tunable Loop™ to optimize dynamic output voltage response
- Fixed switching frequency
- Output overcurrent protection (non-latching)
- Over temperature protection
- Remote On/Off
- Small size: 10.4 mm x 13.5 mm x 8.1 mm
(0.41 in x 0.53 in x 0.32 in)
- Wide operating temperature range (-40°C to 85°C)
- UL* 60950-1 Recognized, CSA† C22.2 No. 60950-1-03 Certified, and VDE‡ 0805:2001-12 (EN60950-1) Licensed
- ISO** 9001 and ISO 14001 certified manufacturing facilities

Description

The NQR002A0X4 SIP power modules are non-isolated dc-dc converters in an industry standard package that can deliver up to 2A of output current with a full load efficiency of 93% at 5.0Vdc output voltage ($V_{IN} = 12Vdc$). These modules operate over a wide range of input voltage ($V_{IN} = 3Vdc-14Vdc$) and provide a precisely regulated output voltage from 0.6Vdc to 5.5Vdc, programmable via an external resistor. Features include remote On/Off, adjustable output voltage, over current and over temperature protection. A new feature, the Tunable Loop™, allows the user to optimize the dynamic response of the converter to match the load.

* UL is a registered trademark of Underwriters Laboratories, Inc.

CSA is a registered trademark of Canadian Standards Association.

VDE is a trademark of Verband Deutscher Elektrotechniker e.V.

** ISO is a registered trademark of the International Organization of Standards

NQR002A0X4: Non-Isolated DC-DC Power Modules

3Vdc –14Vdc input; 0.6Vdc to 5.5Vdc output; 2A Output Current

Absolute Maximum Ratings

Stresses in excess of the absolute maximum ratings can cause permanent damage to the device. These are absolute stress ratings only, functional operation of the device is not implied at these or any other conditions in excess of those given in the operations sections of the data sheet. Exposure to absolute maximum ratings for extended periods can adversely affect the device reliability.

Parameter	Device	Symbol	Min	Max	Unit
Input Voltage Continuous	All	V_{IN}	-0.3	15	Vdc
Operating Ambient Temperature (see Thermal Considerations section)	All	T_A	-40	85	°C
Storage Temperature	All	T_{stg}	-55	125	°C

Electrical Specifications

Unless otherwise indicated, specifications apply over all operating input voltage, resistive load, and temperature conditions.

Parameter	Device	Symbol	Min	Typ	Max	Unit
Operating Input Voltage	All	V_{IN}	3	12	14	Vdc
Maximum Input Current ($V_{IN}=3V$ to 14V, $I_O=I_{O,max}$)	All	$I_{IN,max}$			2.0	Adc
Input No Load Current ($V_{IN} = 9Vdc$, $I_O = 0$, module enabled)	$V_{O,set} = 0.6 Vdc$	$I_{IN,No load}$		20		mA
($V_{IN} = 12Vdc$, $I_O = 0$, module enabled)	$V_{O,set} = 5.0Vdc$	$I_{IN,No load}$		48		mA
Input Stand-by Current ($V_{IN} = 12Vdc$, module disabled)	All	$I_{IN,stand-by}$		1.5		mA
Inrush Transient	All	I^2t			1	A ² s
Input Reflected Ripple Current, peak-to-peak (5Hz to 20MHz, 1 μ H source impedance; $V_{IN}=0$ to 14V, $I_O=I_{O,max}$; See Test Configurations)	All			20		mAp-p
Input Ripple Rejection (120Hz)	All			-65		dB

CAUTION: This power module is not internally fused. An input line fuse must always be used.

This power module can be used in a wide variety of applications, ranging from simple standalone operation to an integrated part of sophisticated power architecture. To preserve maximum flexibility, internal fusing is not included; however, to achieve maximum safety and system protection, always use an input line fuse. The safety agencies require a fast-acting fuse with a maximum rating of 4A (see Safety Considerations section). Based on the information provided in this data sheet on inrush energy and maximum dc input current, the same type of fuse with a lower rating can be used. Refer to the fuse manufacturer's data sheet for further information.

NQR002A0X4: Non-Isolated DC-DC Power Modules

3Vdc –14Vdc input; 0.6Vdc to 5.5Vdc output; 2A Output Current

Electrical Specifications (continued)

Parameter	Device	Symbol	Min	Typ	Max	Unit
Output Voltage Set-point (with 0.5% tolerance for external resistor used to set output voltage)	All	$V_{O,set}$	-1.5		+1.5	% $V_{O,set}$
Output Voltage (Over all operating input voltage, resistive load, and temperature conditions until end of life)	All	$V_{O,set}$	-3.0	—	+3.0	% $V_{O,set}$
Adjustment Range Selected by an external resistor	All	V_o	0.6		5.5	Vdc
Output Regulation (for $V_o \geq 2.5Vdc$) Line ($V_{IN}=V_{IN,min}$ to $V_{IN,max}$)	All		-0.4	—	+0.4	% $V_{O,set}$
Load ($I_o=I_{o,min}$ to $I_{o,max}$)	All			—	0.8	% $V_{O,set}$
Output Regulation (for $V_o < 2.5Vdc$) Line ($V_{IN}=V_{IN,min}$ to $V_{IN,max}$)	All		-10	—	+10	mV
Load ($I_o=I_{o,min}$ to $I_{o,max}$)	All			—	20	mV
Output Ripple and Noise on nominal output ($V_{IN}=V_{IN,nom}$ and $I_o=I_{o,min}$ to $I_{o,max}$ Cout = 22 μ F)						
Peak-to-Peak (5Hz to 20MHz bandwidth)	All		—	50	100	mV _{pk-pk}
RMS (5Hz to 20MHz bandwidth)	All		—	20	38	mV _{rms}
External Capacitance ¹ Without the Tunable Loop™ ESR ≥ 1 m Ω	All	$C_{O,max}$	22	—	47	μ F
With the Tunable Loop™ ESR ≥ 0.15 m Ω	All	$C_{O,max}$	0	—	1000	μ F
ESR ≥ 10 m Ω	All	$C_{O,max}$	0	—	3000	μ F
Output Current	All	I_o	0		2	Adc
Output Current Limit Inception (Hiccup Mode)	All	$I_{o,lim}$		180		% $I_{o,max}$
Output Short-Circuit Current ($V_o \leq 250mV$) (Hiccup Mode)	All	$I_{o,s/c}$		140		mArms
Efficiency ($V_{IN}=6Vdc$) $V_{IN}=12Vdc$, $T_A=25^\circ C$ $I_o=I_{o,max}$, $V_o=V_{O,set}$	$V_{O,set}=0.6Vdc$	η		69.2		%
	$V_{O,set}=1.2Vdc$	η		80.4		%
	$V_{O,set}=1.8Vdc$	η		85.5		%
	$V_{O,set}=2.5Vdc$	η		88.9		%
	$V_{O,set}=3.3Vdc$	η		91		%
	$V_{O,set}=5.0Vdc$	η		93.3		%
Switching Frequency	All	f_{sw}	—	600	—	kHz

¹ External capacitors may require using the new Tunable Loop feature to ensure that the module is stable as well as getting the best transient response. See the Tunable Loop™ section for details.

NQR002A0X4: Non-Isolated DC-DC Power Modules

3Vdc –14Vdc input; 0.6Vdc to 5.5Vdc output; 2A Output Current

General Specifications

Parameter	Min	Typ	Max	Unit
Calculated MTBF ($V_{IN}=12V$, $V_O=5Vdc$, $I_O=0.8I_{O,max}$, $T_A=40^{\circ}C$) Per Telcordia SR-332 Issue3: Method 1, Case 3		138,941,752		Hours
Weight	—	1.2 (0.042)	—	g (oz.)

General Specifications

Unless otherwise indicated, specifications apply over all operating input voltage, resistive load, and temperature conditions. See Feature Descriptions for additional information.

Parameter	Device	Symbol	Min	Typ	Max	Unit
On/Off Signal interface ($V_{IN}=V_{IN,min}$ to $V_{IN,max}$; Open collector or equivalent signal referenced to GND)						
Logic High (Enable pin open - Module ON)						
Input High Current	All	I _{IH}		—	1	mA
Input High Voltage	All	V _{IH}	3.0	—	$V_{IN,max}$	V
Logic Low (Module Off)						
Input Low Current	All	I _{IL}	—	—	10	μA
Input Low Voltage	All	V _{IL}	-0.3	—	0.3	V
Turn-On Delay and Rise Times ($I_O=I_{O,max}$, $V_{IN} = V_{IN,nom}$, V_O to within ±1% of steady state)						
Case 1: Enable input is enabled and then input power is applied (delay from instant at which $V_{IN} = V_{IN,min}$ until $V_O=10\%$ of $V_{O,set}$)	All	T _{delay}		5		msec
Case 2: Input power is applied for at least one second and then Enable input is set enabled (delay from instant at which Enable is enabled until $V_O=10\%$ of V_O .)	All	T _{delay}		5.2		msec
Output voltage Rise time (time for V_O to rise from 10% of $V_{O,set}$ to 90% of $V_{O,set}$)	All	T _{rise}		1.4		msec
Output voltage overshoot $I_O= I_{O,max}$; $V_{IN} = V_{IN,min}$ to $V_{IN,max}$, $T_A = 25^{\circ}C$					3.0	% $V_{O,set}$
Overtemperature Protection	All	T _{ref}		117		°C
Input Undervoltage Lockout						
Turn-on Threshold	All			2.95		Vdc
Turn-off Threshold	All			2.8		Vdc

NQR002A0X4: Non-Isolated DC-DC Power Modules

3Vdc -14Vdc input; 0.6Vdc to 5.5Vdc output; 2A Output Current

Characteristic Curves

The following figures provide typical characteristics for the NQR002 (0.6V, 2A) at 25°C

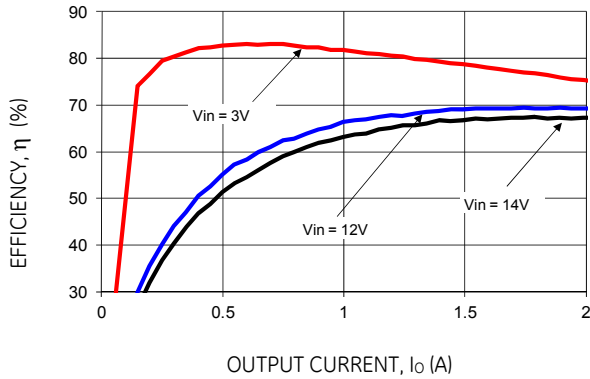

Figure 1. Converter Efficiency versus Output Current.

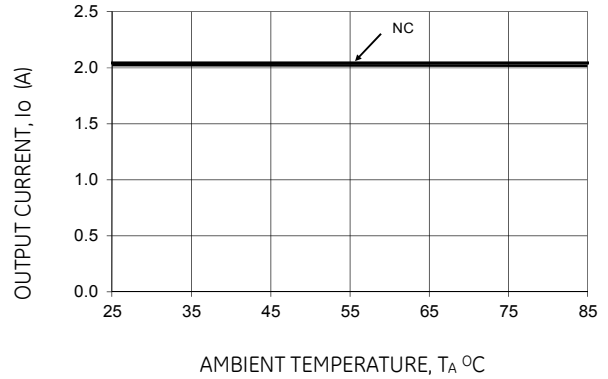

Figure 2. Derating Output Current versus Ambient Temperature and Airflow.

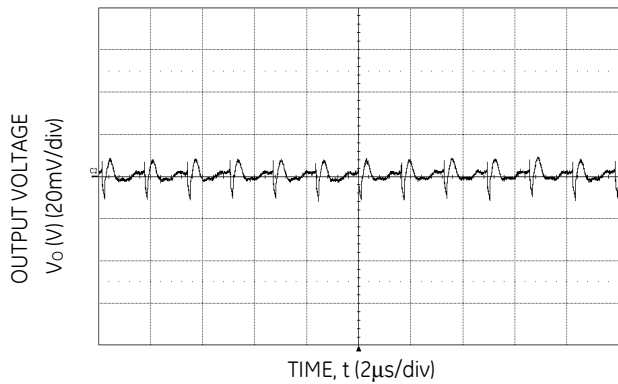

Figure 3. Typical output ripple and noise (VIN = 12V, Io = Io,max).

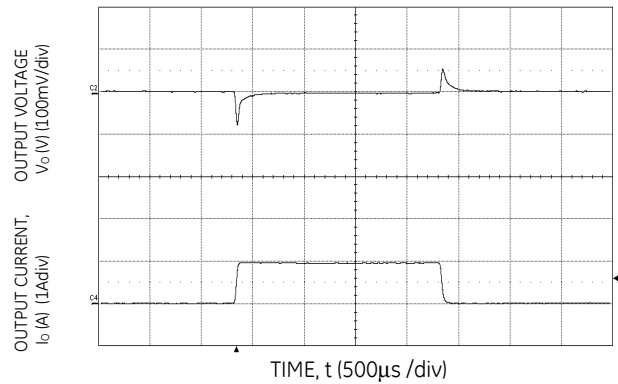

Figure 4. Transient Response to Dynamic Load Change from 0% to 50% to 0% .

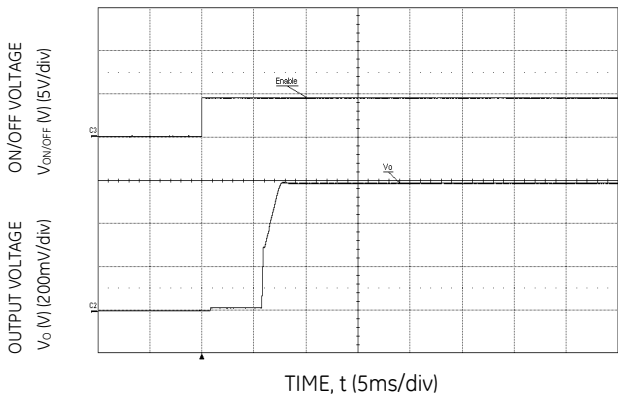

Figure 5. Typical Start-up Using On/Off Voltage (Io = Io,max, Vin=12V,Cext= 22uF).

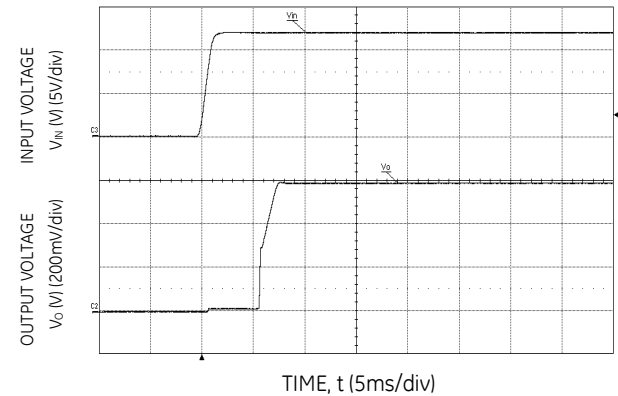

Figure 6. Typical Start-up Using Input Voltage (VIN = 12V, Cext= 22uF ,Io = Io,max).

NQR002A0X4: Non-Isolated DC-DC Power Modules

3Vdc –14Vdc input; 0.6Vdc to 5.5Vdc output; 2A Output Current

Characteristic Curves

The following figures provide typical characteristics for the NQR002 (1.2V, 2A) at 25°C

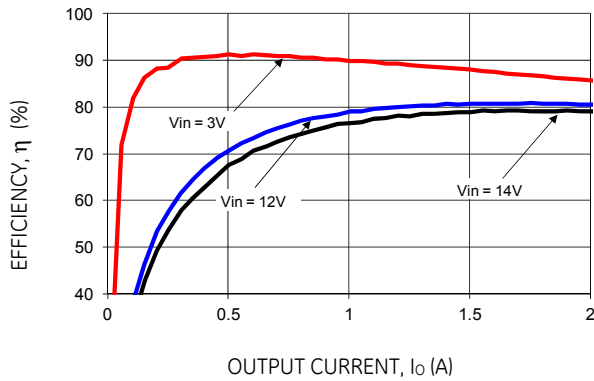

Figure 7. Converter Efficiency versus Output Current.

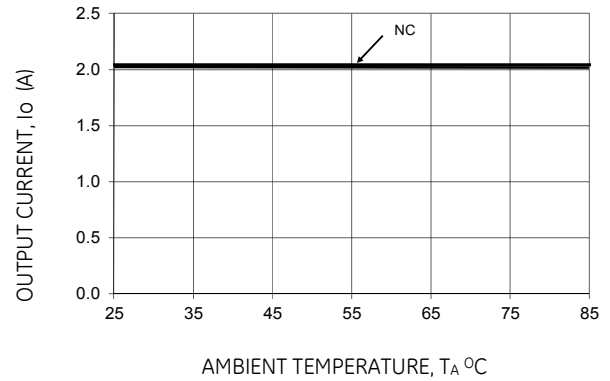

Figure 8. Derating Output Current versus Ambient Temperature and Airflow.

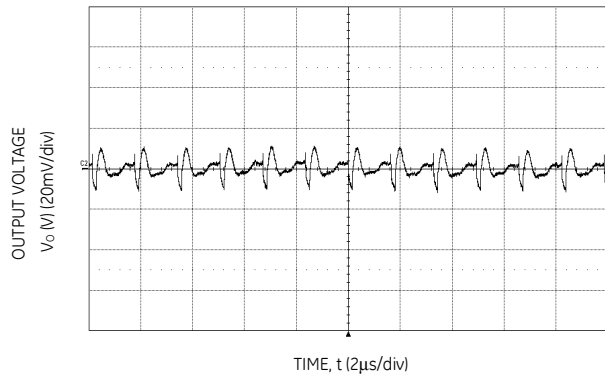

Figure 9. Typical output ripple and noise (VIN = 12V, Io = Io,max).

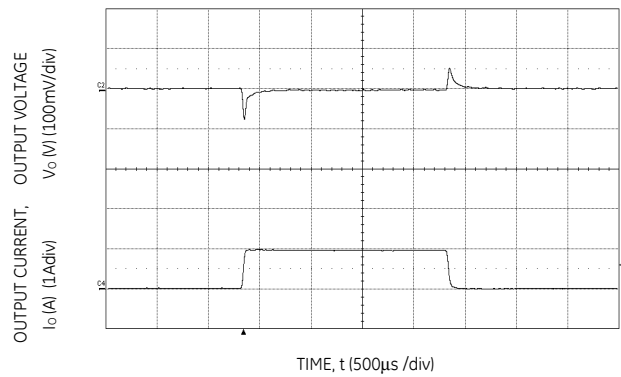

Figure 10. Transient Response to Dynamic Load Change from 0% to 50% to 0%.

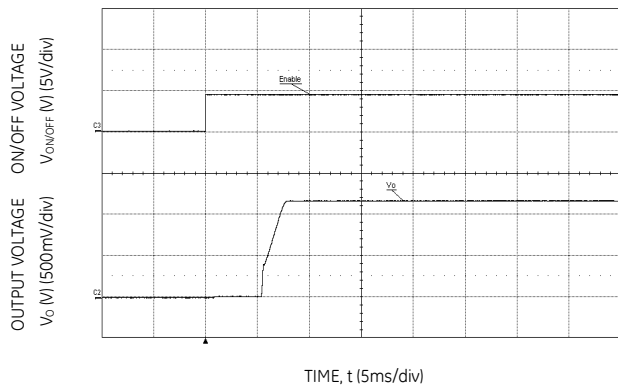

Figure 11. Typical Start-up Using On/Off Voltage (Io = Io,max, Vin=12V, Cext= 22µF).

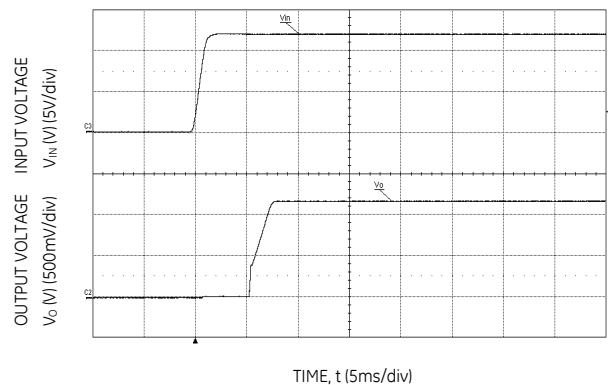

Figure 12. Typical Start-up Using Input Voltage (VIN = 12V, Cext= 22µF, Io = Io,max).

NQR002A0X4: Non-Isolated DC-DC Power Modules

3Vdc -14Vdc input; 0.6Vdc to 5.5Vdc output; 2A Output Current

Characteristic Curves

The following figures provide typical characteristics for the NQR002 (1.8V, 2A) at 25°C.

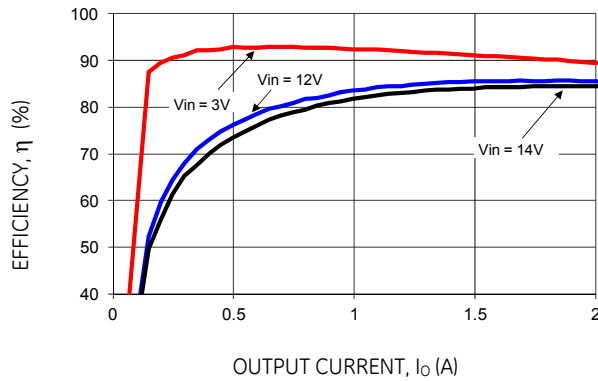

Figure 13. Converter Efficiency versus Output Current.

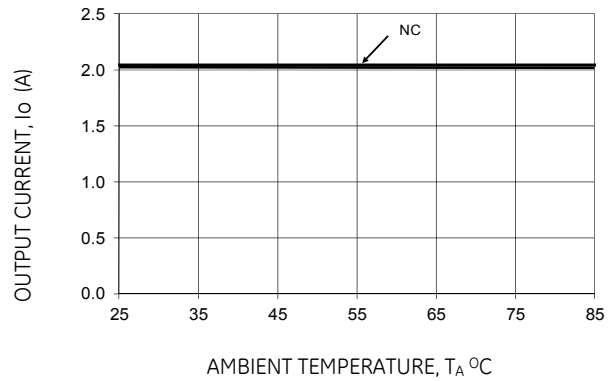

Figure 14. Derating Output Current versus Ambient Temperature and Airflow.

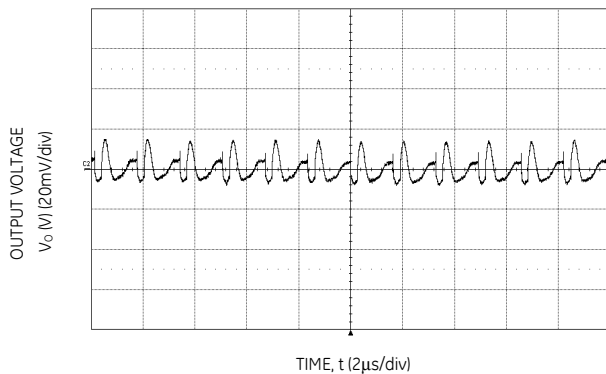

Figure 15. Typical output ripple and noise (VIN = 12V, Io = Io,max).

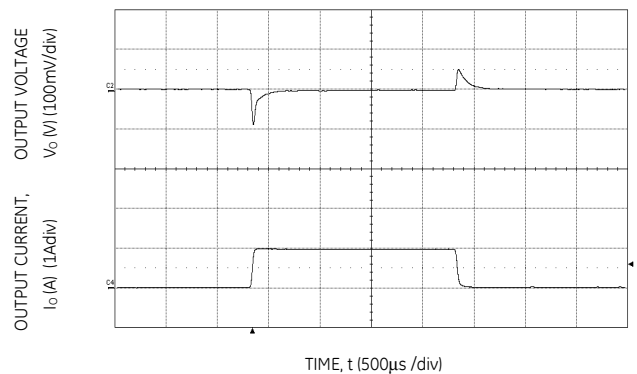

Figure 16. Transient Response to Dynamic Load Change from 0% to 50% to 0%.

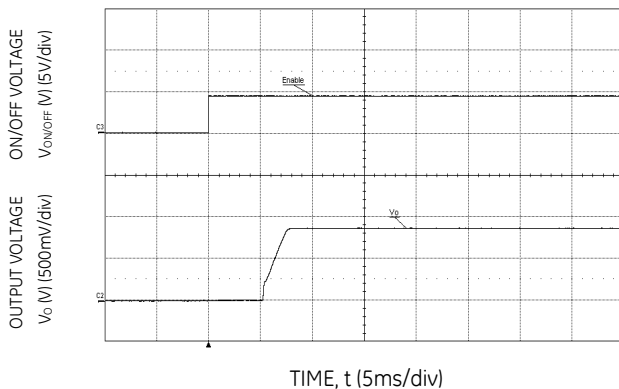

Figure 17. Typical Start-up Using On/Off Voltage (Io = Io,max, Vin=12V,Cext=22µF,).

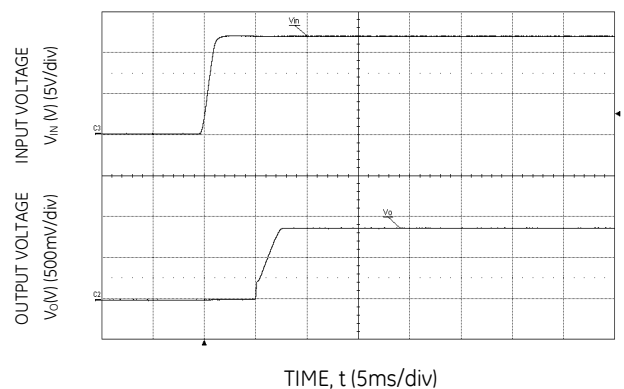

Figure 18. Typical Start-up Using Input Voltage (VIN = 12V, Cext=22µF, Io = Io,max).

NQR002A0X4: Non-Isolated DC-DC Power Modules

3Vdc –14Vdc input; 0.6Vdc to 5.5Vdc output; 2A Output Current

Characteristic Curves

The following figures provide typical characteristics for the NQR002 (2.5V, 2A) at 25°C.

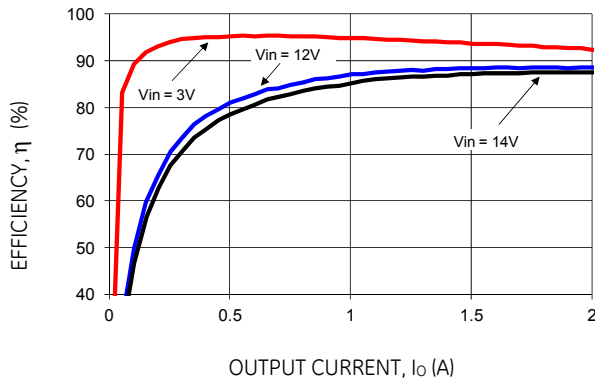

Figure 19. Converter Efficiency versus Output Current.

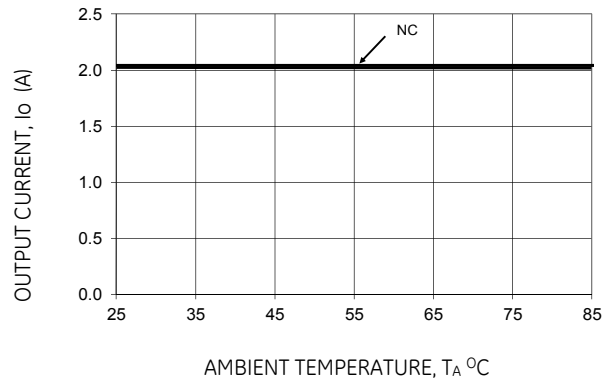

Figure 20. Derating Output Current versus Ambient Temperature and Airflow.

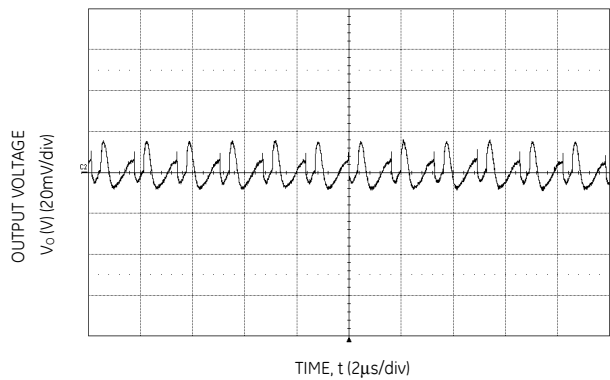

Figure 21. Typical output ripple and noise (VIN = 12V, Io = Io,max).

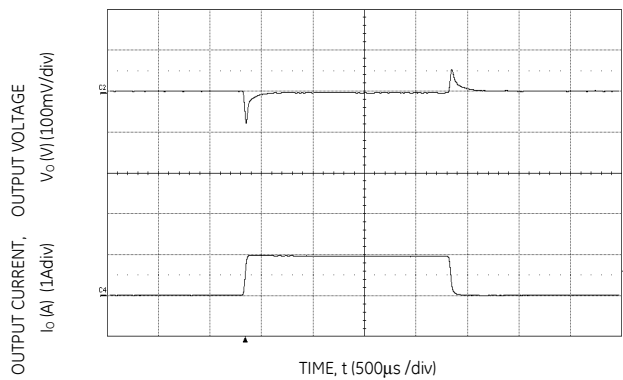

Figure 22. Transient Response to Dynamic Load Change from 0% to 50% to 0%.

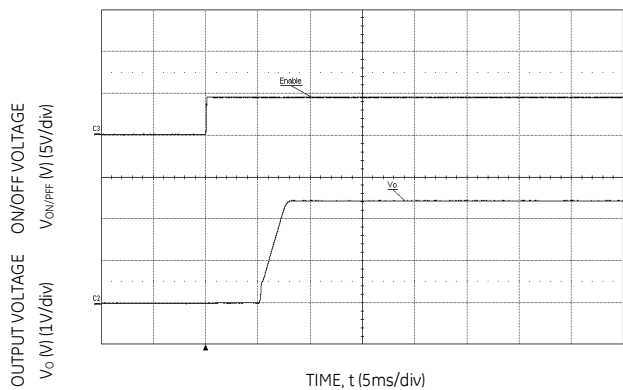

Figure 23. Typical Start-up Using On/Off Voltage (Io = Io,max, Vin=12V,Cext= 22uF).

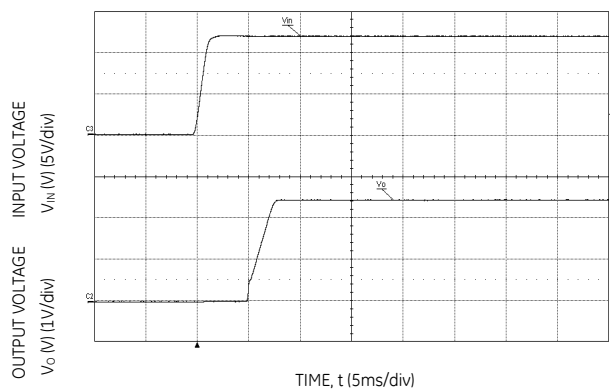

Figure 24. Typical Start-up Using Input Voltage (VIN = 12V, Cext= 22uF, Io = Io,max).

NQR002A0X4: Non-Isolated DC-DC Power Modules

3Vdc -14Vdc input; 0.6Vdc to 5.5Vdc output; 2A Output Current

Characteristic Curves

The following figures provide typical characteristics for the NQR002 (3.3V, 2A) at 25°C.

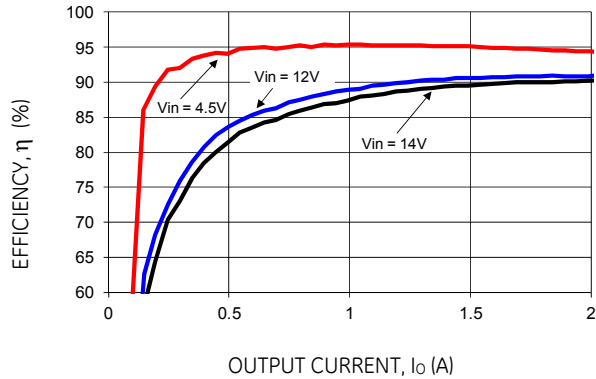

Figure 25. Converter Efficiency versus Output Current.

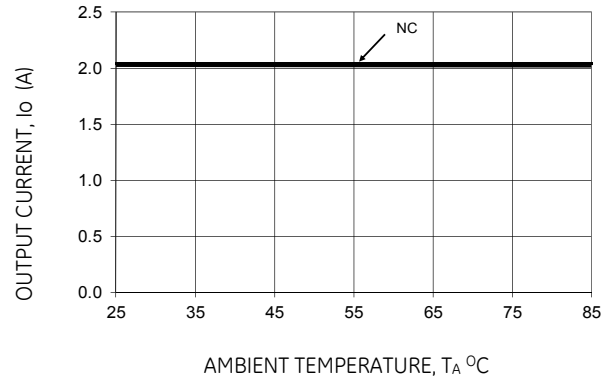

Figure 26. Derating Output Current versus Ambient Temperature and Airflow.

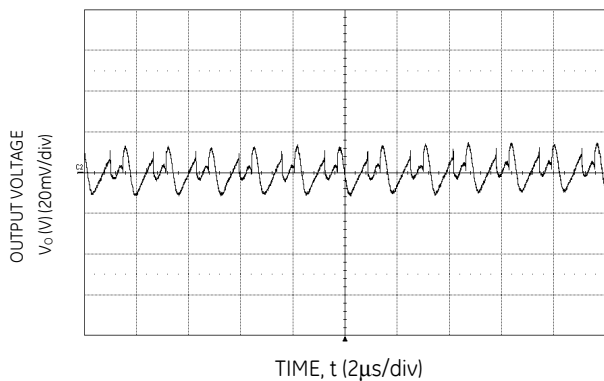

Figure 27. Typical output ripple and noise (VIN = 12V, Io = Io,max).

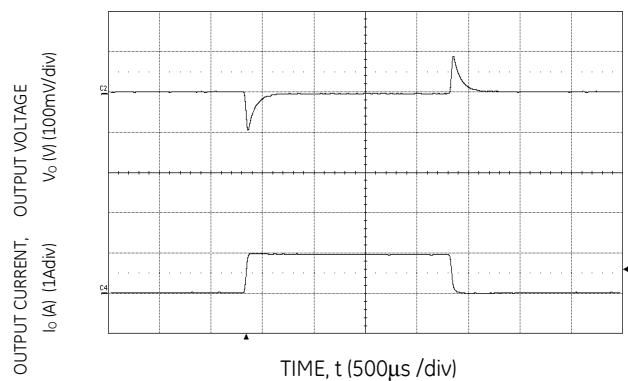

Figure 28. Transient Response to Dynamic Load Change from 0% to 50% to 0%.

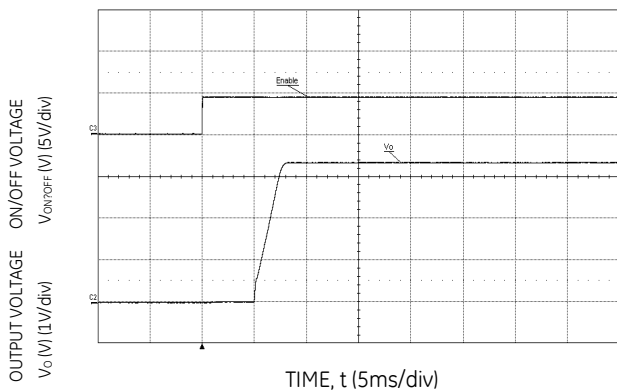

Figure 29. Typical Start-up Using On/Off Voltage (Io = Io,max, Vin=12V, Cext= 22uF)

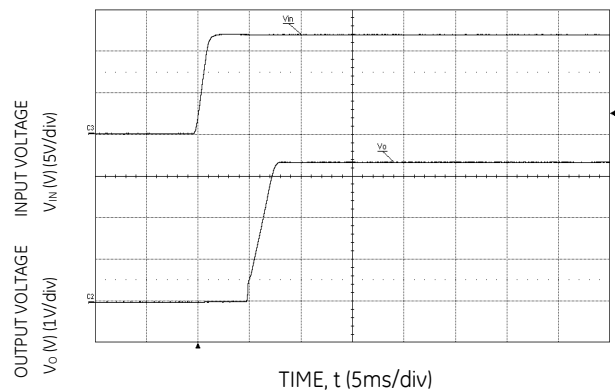

Figure 30. Typical Start-up Using Input Voltage (VIN = 12V, Cext= 22uF, Io = Io,max).

NQR002A0X4: Non-Isolated DC-DC Power Modules

3Vdc -14Vdc input; 0.6Vdc to 5.5Vdc output; 2A Output Current

Characteristic Curves

The following figures provide typical characteristics for the NQR002 (5V, 2A) at 25°C.

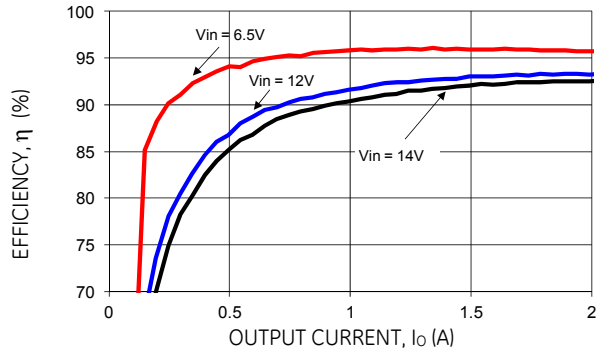

Figure 31. Converter Efficiency versus Output Current.

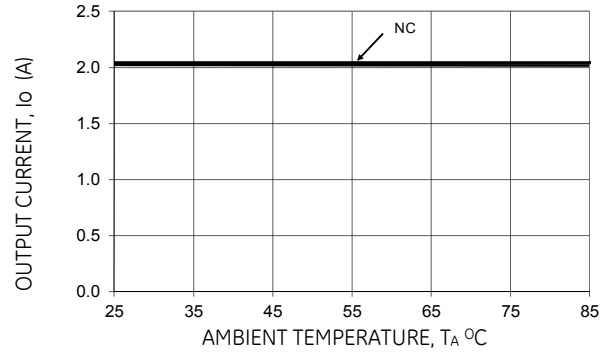

Figure 32. Derating Output Current versus Ambient Temperature and Airflow.

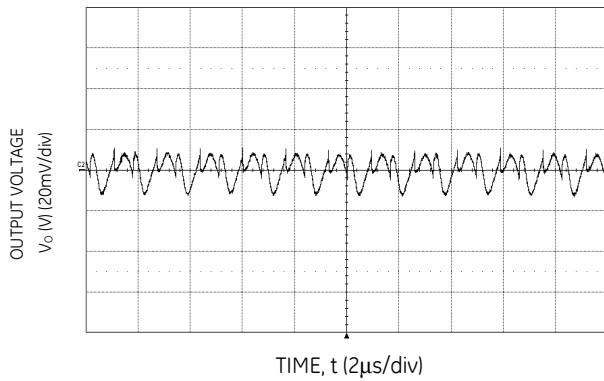

Figure 33. Typical output ripple and noise (VIN = 12V, Io = Io,max).

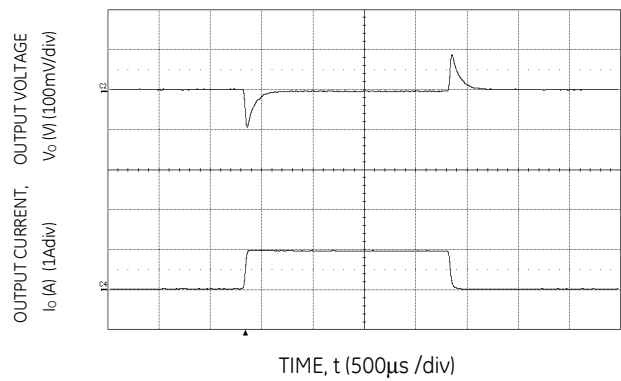

Figure 34. Transient Response to Dynamic Load Change from 0% to 50% to 0%.

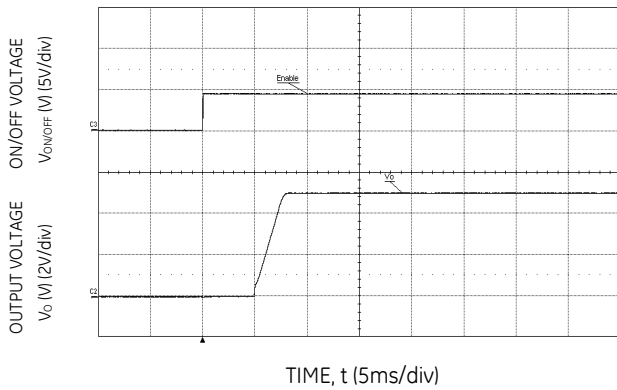

Figure 35. Typical Start-up Using On/Off Voltage (Io = Io,max, Vin=12V, Cext= 22µF).

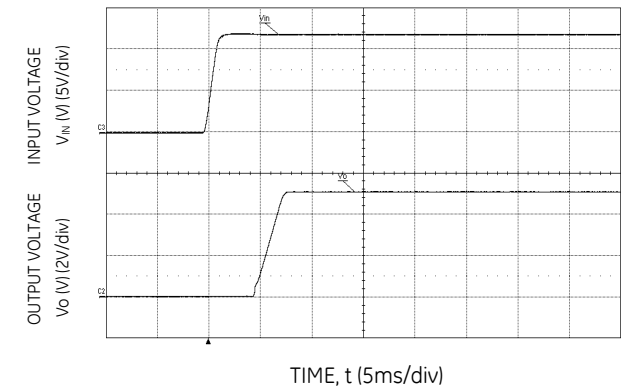
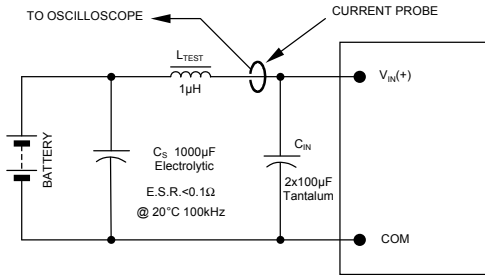

Figure 36. Typical Start-up Using Input Voltage (VIN = 12V, Io = Io,max, Cext= 22µF).

NQR002A0X4: Non-Isolated DC-DC Power Modules

3Vdc –14Vdc input; 0.6Vdc to 5.5Vdc output; 2A Output Current

Test Configurations



NOTE: Measure input reflected ripple current with a simulated source inductance (L_{TEST}) of 1µH. Capacitor C_S offsets possible battery impedance. Measure current as shown above.

Figure 1. Input Reflected Ripple Current Test Setup.

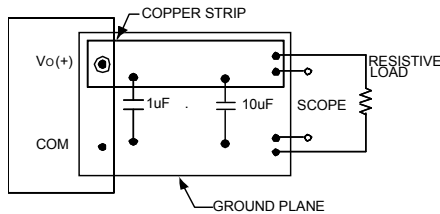

NOTE: All voltage measurements to be taken at the module terminals, as shown above. If sockets are used then Kelvin connections are required at the module terminals to avoid measurement errors due to socket contact resistance.

Figure 2. Output Ripple and Noise Test Setup.

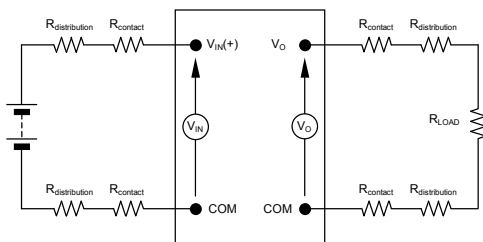

NOTE: All voltage measurements to be taken at the module terminals, as shown above. If sockets are used then Kelvin connections are required at the module terminals to avoid measurement errors due to socket contact resistance.

Figure 3. Output Voltage and Efficiency Test Setup.

$$\text{Efficiency } \eta = \frac{V_O \cdot I_O}{V_{IN} \cdot I_{IN}} \times 100 \%$$

Design Considerations

Input Filtering

The NQR002A0X4 2A module should be connected to a low ac-impedance source. A highly inductive source can affect the stability of the module. An input capacitance must be placed directly adjacent to the input pin of the module, to minimize input ripple voltage and ensure module stability.

To minimize input voltage ripple, low-ESR ceramic or polymer capacitors are recommended at the input of the module. Figure 4 shows the input ripple voltage for various output voltages at 2A of load current with 1x10 µF or 1x22 µF ceramic capacitors and an input of 12V.

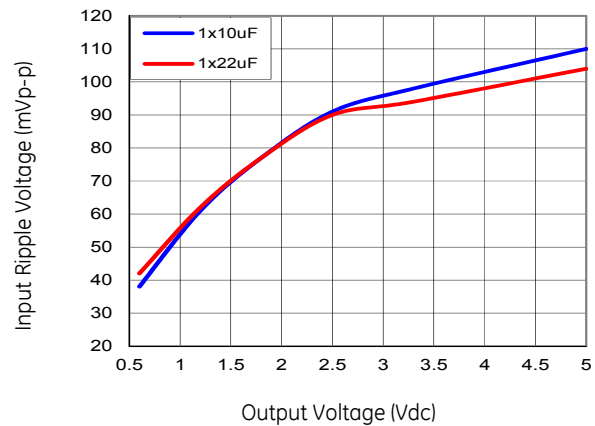

Figure 4. Input ripple voltage for various output voltages with 1x10 µF or 1x22 µF ceramic capacitors at the input (2A load). Input voltage is 12V.

Output Filtering

The NQR002A0X4 2A modules are designed for low output ripple voltage and will meet the maximum output ripple specification with no external capacitors. However, additional output filtering may be required by the system designer for a number of reasons. First, there may be a need to further reduce the output ripple and noise of the module. Second, the dynamic response characteristics may need to be customized to a particular load step change.

To reduce the output ripple and improve the dynamic response to a step load change, additional capacitance at the output can be used. Low ESR ceramic and polymer are recommended to improve the dynamic response of the module. Figure 5 provides output ripple information for different external capacitance values at various V_O and for a load current of 2A. For stable operation of the module, limit the capacitance to less than the maximum output capacitance as specified in the electrical specification table. Optimal performance of the module can be achieved by using the Tunable Loop™ feature described later in this data sheet.

NQR002A0X4: Non-Isolated DC-DC Power Modules

3Vdc –14Vdc input; 0.6Vdc to 5.5Vdc output; 2A Output Current

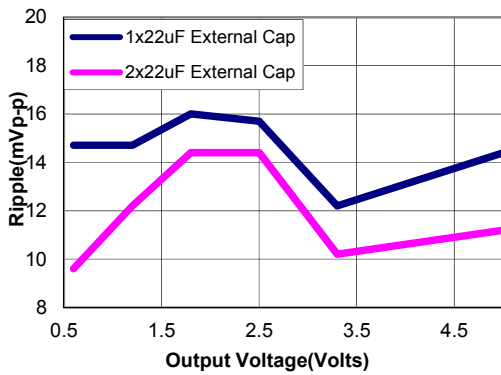

Figure 5. Output ripple voltage for various output voltages with external 1x22 μ F, 2x22 μ F ceramic capacitors at the output (2A load). Input voltage is 12V.

Safety Considerations

For safety agency approval the power module must be installed in compliance with the spacing and separation requirements of the end-use safety agency standards, i.e., UL 60950-1, CSA C22.2 No. 60950-1-03, and VDE 0850:2001-12 (EN60950-1) Licensed.

For the converter output to be considered meeting the requirements of safety extra-low voltage (SELV), the input must meet SELV requirements. The power module has extra-low voltage (ELV) outputs when all inputs are ELV.

An input fuse for the module is recommended. Due to the wide input voltage and output voltage ranges of the module, a 4A, 125Vdc fast acting fuse is recommended

Feature Descriptions

Enable (Remote On/Off)

The NQR002A0X4 2A power modules feature a Enable pin with positive logic for remote On/Off operation. If the Enable pin is not being used, leave the pin open (the module will be ON). The Enable signal ($V_{ON/OFF}$) is referenced to ground. During a Logic High on the Enable pin, the module remains ON. During Logic-Low, the module is turned OFF.

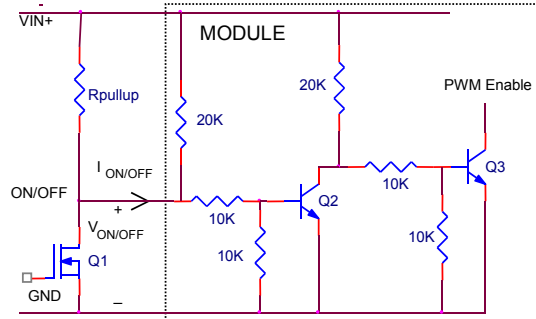

Figure 6. Remote On/Off Implementation(positive logic).

Overcurrent Protection

To provide protection in a fault (output overload) condition, the unit is equipped with internal current-limiting circuitry and can endure current limiting continuously. At the point of current-limit inception, the unit enters hiccup mode. The unit operates normally once the output current is brought back into its specified range. The average output current during hiccup is 10% $I_{o,max}$.

Overtemperature Protection

To provide protection in a fault condition, these modules are equipped with a thermal shutdown circuit. The unit will shut down if the overtemperature threshold of 130°C is exceeded at the thermal reference point T_{ref} . The thermal shutdown is not intended as a guarantee that the unit will survive temperatures beyond its rating. Once the unit goes into thermal shutdown it will then wait to cool before attempting to restart.

Input Undervoltage Lockout

At input voltages below the input undervoltage lockout limit, the module operation is disabled. The module will begin to operate at an input voltage above the undervoltage lockout turn-on threshold.

Output Voltage Programming

The output voltage of the NQR002A0X4 2A module can be programmed to any voltage from 0.6dc to 5.5Vdc by connecting a resistor between the Trim+ and GND pins of the module. Certain restrictions apply on the output voltage set point depending on the input voltage. These are shown in the Output Voltage vs. Input Voltage Set Point Area plot in Fig. 7. The Lower Limit curve shows that for output voltages of 2.4V and higher, the input voltage needs to be larger than the minimum of 3V.

NQR002A0X4: Non-Isolated DC-DC Power Modules

3Vdc –14Vdc input; 0.6Vdc to 5.5Vdc output; 2A Output Current

Feature Descriptions (continued)

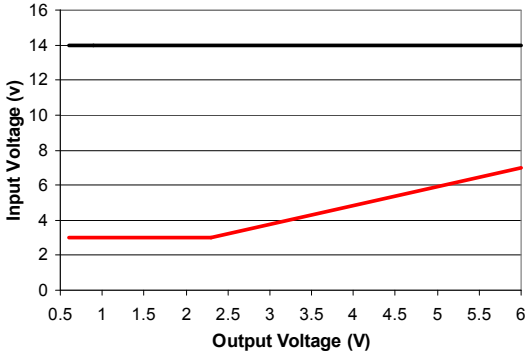

Figure 7. Output Voltage vs. Input Voltage Set Point Area plot showing limits where the output voltage can be set for different input voltages.

Without an external resistor between Trim+ and GND pins, the output of the module will be 0.6Vdc. To calculate the value of the trim resistor, *Rtrim* for a desired output voltage, use the following equation:

$$R_{trim} = \left[\frac{12}{(V_o - 0.6)} \right] k\Omega$$

Rtrim is the external resistor in kΩ

Vo is the desired output voltage

Table 1 provides *Rtrim* values required for some common output voltages.

Table 1

<i>V_{o, set}</i> (V)	<i>Rtrim</i> (kΩ)
0.6	Open
0.9	40
1.0	30
1.2	20
1.5	13.33
1.8	10
2.5	6.316
3.3	4.444
5.0	2.727

By using a ±0.5% tolerance trim resistor with a TC of ±25ppm, a set point tolerance of ±1.5% can be achieved as specified in the electrical specification. The POL Programming Tool available at www.lineagepower.com under the Design Tools section, helps determine the required trim resistor needed for a specific output voltage.

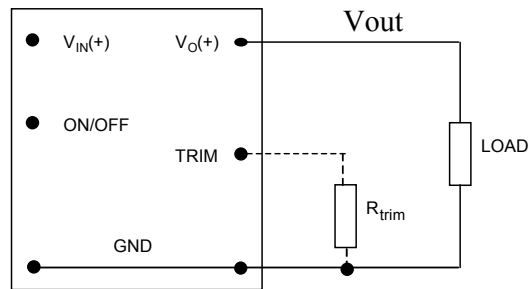

Figure 8. Circuit configuration for programming output voltage using an external resistor.

Voltage Margining

Output voltage margining can be implemented in the NQR002A0X4 2A modules by connecting a resistor, *R_{margin-up}*, from the Trim pin to the ground pin for margining-up the output voltage and by connecting a resistor, *R_{margin-down}*, from the Trim pin to output pin for margining-down. Figure 9 shows the circuit configuration for output voltage margining. The POL Programming Tool, available at www.lineagepower.com under the Design Tools section, also calculates the values of *R_{margin-up}* and *R_{margin-down}* for a specific output voltage and % margin. Please consult your local Lineage Power Field Application Engineer or Account Manager for additional details.

NQR002A0X4: Non-Isolated DC-DC Power Modules

3Vdc –14Vdc input; 0.6Vdc to 5.5Vdc output; 2A Output Current

Feature Descriptions (continued)

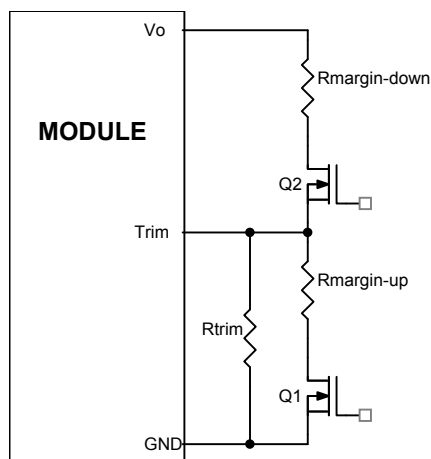

Figure 9. Circuit Configuration for margining Output voltage.

Monotonic Start-up and Shutdown

The NQR002A0X4 2A modules have monotonic start-up and shutdown behavior for any combination of rated input voltage, output current and operating temperature range.

Tunable Loop™

The NQR002A0X4 2A modules have a new feature that optimizes transient response of the module called Tunable Loop™. External capacitors are usually added to improve output voltage transient response due to load current changes. Sensitive loads may also require additional output capacitance to reduce output ripple and noise. Adding external capacitance however affects the voltage control loop of the module, typically causing the loop to slow down with sluggish response. Larger values of external capacitance could also cause the module to become unstable.

To use the additional external capacitors in an optimal manner, the Tunable Loop™ feature allows the loop to be tuned externally by connecting a series R-C between the VOUT and TRIM pins of the module, as shown in Fig. 10. This R-C allows the user to externally adjust the voltage loop feedback compensation of the module to match the filter network connected to the output of the module.

Recommended values of R_{TUNE} and C_{TUNE} are given in Tables 2 and 3. Table 2 lists recommended values of R_{TUNE} and C_{TUNE} in order to meet 2% output voltage deviation limits for some common output voltages in the presence of a 1A to 2A step change (50% of full load), with an input voltage of 12V. Table 3 shows the recommended values of R_{TUNE} and C_{TUNE} for different values of ceramic output capacitors up to TBD, again for an input voltage of 12V. The value of R_{TUNE} should never be lower than the values shown in Tables 3 and 4. Please contact your Lineage Power technical representative to obtain more details of this feature as well as for guidelines on how to select the

right value of external R-C to tune the module for best transient performance and stable operation for other output capacitance values.

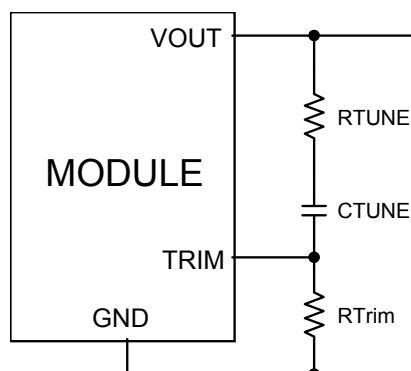

Figure 10. Circuit diagram showing connection of R_{TUNE} and C_{TUNE} to tune the control loop of the module.

Table 2. Recommended values of R_{TUNE} and C_{TUNE} to obtain transient deviation of 2% of V_{out} for a 1A step load with $V_{in}=12V$.

Co	1x47µF	2x47µF	3x47µF	4x47µF	10x47µF
R_{TUNE}	220	150	100	100	100
C_{TUNE}	3900pF	10nF	18nF	18nF	22nF

Table 3. General recommended values of R_{TUNE} and C_{TUNE} for $V_{in}=12V$ and various external ceramic capacitor combinations.

V_o	5V	3.3V	2.5V	1.8V	1.2V	0.6V
Co	x22µF	1x47µF	2x47µF	2x47µF	3x47µF	330µF Polymer
R_{TUNE}	220	220	150	150	100	100
C_{TUNE}	200pF	3900pF	10nF	10nF	18nF	68nF
ΔV	81mV	61mV	35mV	34mV	23mV	12mV

Table 4. Recommended values of R_{TUNE} and C_{TUNE} to obtain transient deviation of $\leq 2\%$ of V_{out} for a 1A step load with $V_{in}=5V$

V_o	3.3V	2.5V	1.8V	1.2V	0.6V
Co	1x47µF	2x47µF	2x47µF	3x47µF	330µF Polymer
R_{TUNE}	220	150	150	100	100
C_{TUNE}	3900pF	10nF	10nF	18nF	68nF
ΔV	62mV	35mV	34mV	23mV	12mV

NQR002A0X4: Non-Isolated DC-DC Power Modules

3Vdc –14Vdc input; 0.6Vdc to 5.5Vdc output; 2A Output Current

Table 5. Recommended values of R_{TUNE} and C_{TUNE} to obtain transient deviation of $\leq 2\%$ of V_{out} for a 1A step load with $V_{in}=3.3V$

V_o	2.5V	1.8V	1.2V	0.6V
C_o	3x47 μ F	2x47 μ F	3x47 μ F	330 μ F Polymer
R_{TUNE}	100	150	100	100
C_{TUNE}	18nF	10nF	18nF	68nF
ΔV	48mV	34mV	23mV	12mV

NQR002A0X4: Non-Isolated DC-DC Power Modules

3Vdc –14Vdc input; 0.6Vdc to 5.5Vdc output; 2A Output Current

Thermal Considerations

Power modules operate in a variety of thermal environments; however, sufficient cooling should be provided to help ensure reliable operation.

Considerations include ambient temperature, airflow, module power dissipation, and the need for increased reliability. A reduction in the operating temperature of the module will result in an increase in reliability. The thermal data presented here is based on physical measurements taken in a wind tunnel. The test set-up is shown in Figure 11. The preferred airflow direction for the module is in Figure 12.

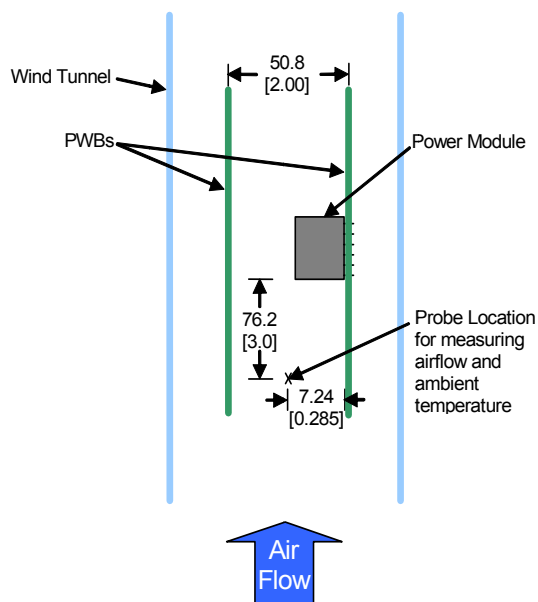

Figure 11. Thermal Test Set-up.

The thermal reference point, T_{ref} used in the specifications of thermal derating curves is shown in Figure 12. For reliable operation this temperature should not exceed 120°C.

The output power of the module should not exceed the rated power of the module ($V_{o,set} \times I_{o,max}$).

Please refer to the Application Note “Thermal Characterization Process For Open-Frame Board-Mounted Power Modules” for a detailed discussion of thermal aspects including maximum device temperatures.

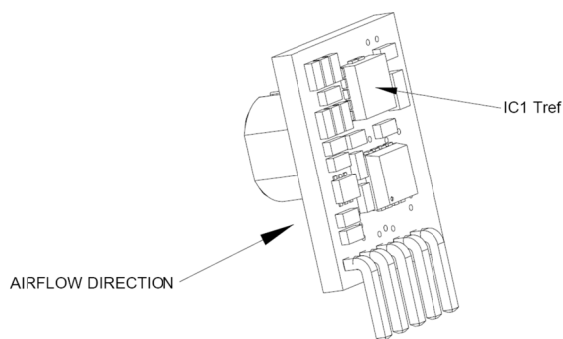

Figure 12. T_{ref} Temperature measurement location.

Post solder Cleaning and Drying Considerations

Post solder cleaning is usually the final circuit-board assembly process prior to electrical board testing. The result of inadequate cleaning and drying can affect both the reliability of a power module and the testability of the finished circuit-board assembly. For guidance on appropriate soldering, cleaning and drying procedures, refer to *Board Mounted Power Modules: Soldering and Cleaning Application Note*.

Through-Hole Lead-Free Soldering Information

These RoHS-compliant through-hole products use the SAC (Sn/Ag/Cu) Pb-free solder and RoHS-compliant components. They are designed to be processed through single or dual wave soldering machines. The pins have an RoHS-compliant finish that is compatible with both Pb and Pb-free wave soldering processes. A maximum preheat rate of 3°C/s is suggested. The wave preheat process should be such that the temperature of the power module board is kept below 210°C. For Pb solder, the recommended pot temperature is 260°C, while the Pb-free solder pot is 270°C max. Not all RoHS-compliant through-hole products can be processed with paste-through-hole Pb or Pb-free reflow process. If additional information is needed, please consult with your Lineage Power representative for more details.

NQR002A0X4: Non-Isolated DC-DC Power Modules

3Vdc –14Vdc input; 0.6Vdc to 5.5Vdc output; 2A Output Current

Example Application Circuit

Requirements:

Vin:	12V
Vout:	1.8V
Iout:	1A max., worst case load transient is from 1A to 1.5A
Δ Vout:	1.5% of Vout (27mV) for worst case load transient
Vin, ripple	1.5% of Vin (180mV, p-p)

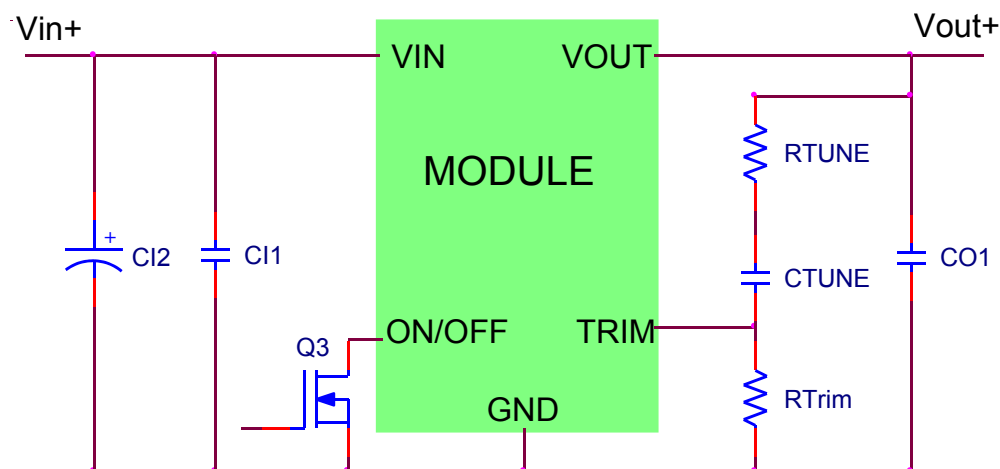

C11	1x10 μ F/16V ceramic capacitor (e.g. TDK C Series)
C12	100 μ F/16V bulk electrolytic
CO1	1x47 μ F/6.3V ceramic capacitor (e.g. TDK C Series, Murata GRM32ER60J476ME20)
CTune	3900pF ceramic capacitor (can be 1206, 0805 or 0603 size)
RTune	180 ohms SMT resistor (can be 1206, 0805 or 0603 size)
RTrim	5k Ω SMT resistor (can be 1206, 0805 or 0603 size, recommended tolerance of 0.1%)

NQR002A0X4: Non-Isolated DC-DC Power Modules

3Vdc –14Vdc input; 0.6Vdc to 5.5Vdc output; 2A Output Current

Mechanical Outline

Dimensions are in millimeters and (inches).

Tolerances: x.x mm ± 0.5 mm (x.xx in. ± 0.02 in.) [unless otherwise indicated]

x.xx mm ± 0.25 mm (x.xxx in ± 0.010 in.)

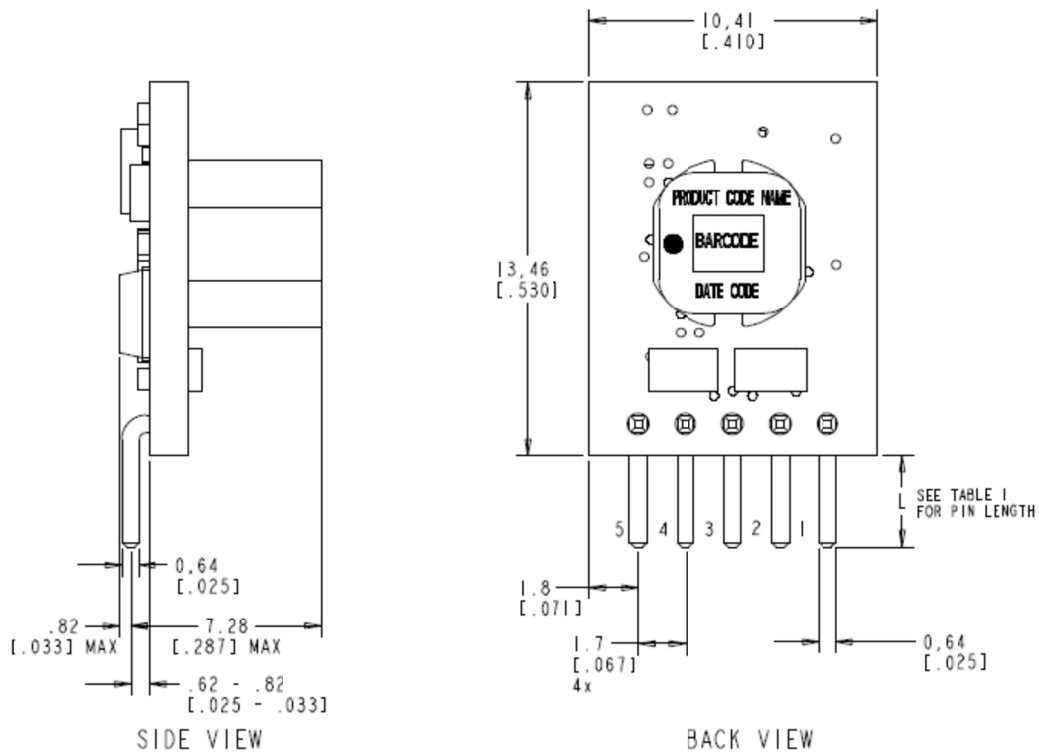

Pin Out

PIN	Function
1	On/Off
2	V _{in}
3	GND
4	V _{out}
5	Trim+

TABLE I

PRODUCT OPTION	PIN LENGTH "L" MM [INCH]
STANDARD	3.29 [0.130]
OPTION - 6	2.85 [0.112]
OPTION - 54	5.08 [0.200]

NQR002A0X4: Non-Isolated DC-DC Power Modules

3Vdc -14Vdc input; 0.6Vdc to 5.5Vdc output; 2A Output Current

Recommended Pad Layout

Dimensions are in millimeters and (inches).

Tolerances: x.x mm ± 0.5 mm (x.xx in. ± 0.02 in.) [unless otherwise indicated]

x.xx mm ± 0.25 mm (x.xxx in ± 0.010 in.)

RECOMMENDED PAD LAYOUT

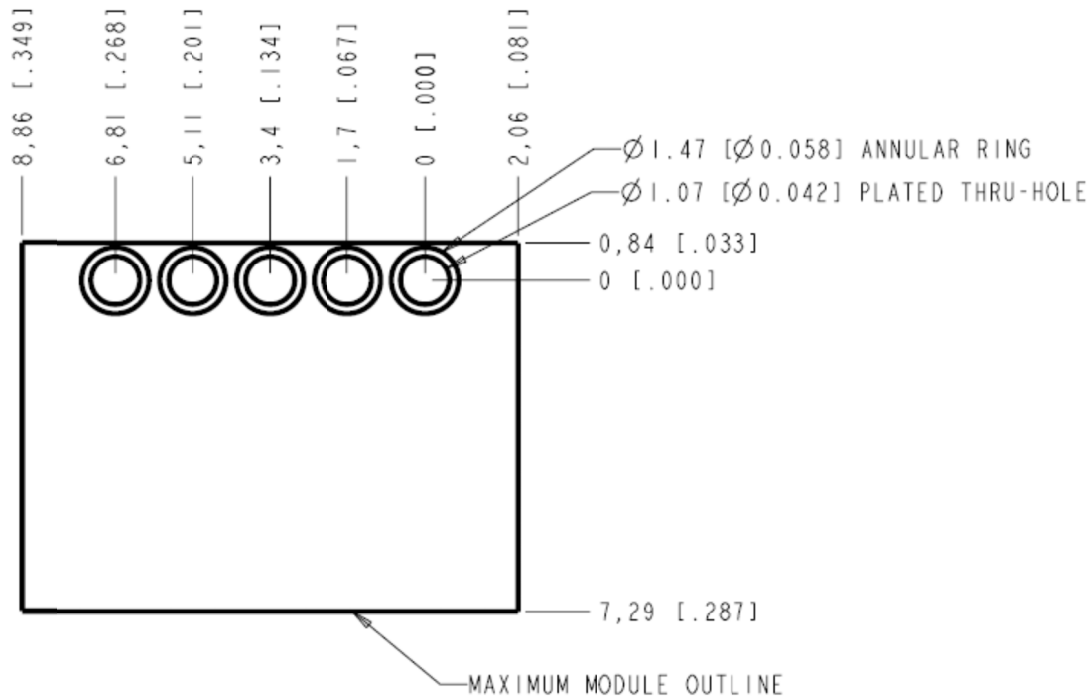

TO INCREASE COPPER ADHESION,
ELLIPTICAL PADS CAN BE UTILIZED

NQR002A0X4: Non-Isolated DC-DC Power Modules

3Vdc –14Vdc input; 0.6Vdc to 5.5Vdc output; 2A Output Current

Ordering Information

Please contact your Lineage Power Sales Representative for pricing, availability and optional features.

Table 4. Device Codes

Device Code	Input Voltage Range	Output Voltage	Output Current	On/Off Logic	Connector Type	Comcodes
NQR002A0X4Z	3 – 14Vdc	0.6 – 5.5Vdc	2A	Positive	SIP	CC109171468

-Z refers to RoHS compliant parts

Contact Us

For more information, call us at

USA/Canada:

+1 888 546 3243, or +1 972 244 9288

Asia-Pacific:

+86.021.54279977*808

Europe, Middle-East and Africa:

+49.89.878067-280

India:

+91.80.28411633

www.gecriticalpower.com



imagination at work

GE Critical Power reserves the right to make changes to the product(s) or information contained herein without notice, and no liability is assumed as a result of their use or application. No rights under any patent accompany the sale of any such product(s) or information.