



Chipsmall Limited consists of a professional team with an average of over 10 year of expertise in the distribution of electronic components. Based in Hongkong, we have already established firm and mutual-benefit business relationships with customers from,Europe,America and south Asia,supplying obsolete and hard-to-find components to meet their specific needs.

With the principle of "Quality Parts,Customers Priority,Honest Operation,and Considerate Service",our business mainly focus on the distribution of electronic components. Line cards we deal with include Microchip,ALPS,ROHM,Xilinx,Pulse,ON,Everlight and Freescale. Main products comprise IC,Modules,Potentiometer,IC Socket,Relay,Connector.Our parts cover such applications as commercial,industrial, and automotives areas.

We are looking forward to setting up business relationship with you and hope to provide you with the best service and solution. Let us make a better world for our industry!



## Contact us

Tel: +86-755-8981 8866 Fax: +86-755-8427 6832

Email & Skype: info@chipsmall.com Web: www.chipsmall.com

Address: A1208, Overseas Decoration Building, #122 Zhenhua RD., Futian, Shenzhen, China



# MUN5137DW1, NSBA144WDXV6, NSBA144WDP6

## Dual PNP Bias Resistor Transistors R1 = 47 kΩ, R2 = 22 kΩ

### PNP Transistors with Monolithic Bias Resistor Network

This series of digital transistors is designed to replace a single device and its external resistor bias network. The Bias Resistor Transistor (BRT) contains a single transistor with a monolithic bias network consisting of two resistors; a series base resistor and a base-emitter resistor. The BRT eliminates these individual components by integrating them into a single device. The use of a BRT can reduce both system cost and board space.

#### Features

- S and NSV Prefix for Automotive and Other Applications Requiring Unique Site and Control Change Requirements; AEC-Q101 Qualified and PPAP Capable
- Simplifies Circuit Design
- Reduces Board Space
- Reduces Component Count
- These Devices are Pb-Free, Halogen Free/BFR Free and are RoHS Compliant

#### MAXIMUM RATINGS

(T<sub>A</sub> = 25°C, common for Q1 and Q2, unless otherwise noted)

Rating	Symbol	Max	Unit
Collector-Base Voltage	V <sub>CBO</sub>	50	Vdc
Collector-Emitter Voltage	V <sub>CEO</sub>	50	Vdc
Collector Current - Continuous	I <sub>C</sub>	100	mAdc
Input Forward Voltage	V <sub>IN(fwd)</sub>	40	Vdc
Input Reverse Voltage	V <sub>IN(rev)</sub>	10	Vdc

Stresses exceeding those listed in the Maximum Ratings table may damage the device. If any of these limits are exceeded, device functionality should not be assumed, damage may occur and reliability may be affected.

#### ORDERING INFORMATION

Device	Package	Shipping†
MUN5137DW1T1G	SOT-363	3,000 / Tape & Reel
NSVMUN5137DW1T1G	SOT-363	3,000 / Tape & Reel
NSBA144WDXV6T1G	SOT-563	4,000 / Tape & Reel
NSBA144WDP6T5G	SOT-963	8,000 / Tape & Reel

†For information on tape and reel specifications, including part orientation and tape sizes, please refer to our Tape and Reel Packaging Specifications Brochure, BRD8011/D.



ON Semiconductor®

[www.onsemi.com](http://www.onsemi.com)

#### PIN CONNECTIONS

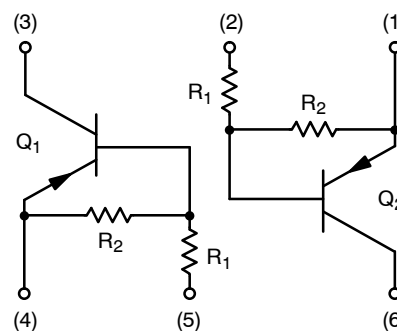

#### MARKING DIAGRAMS

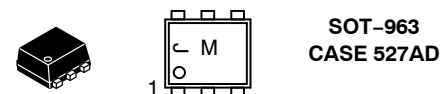
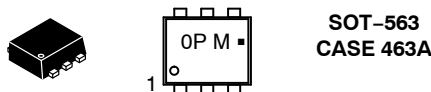
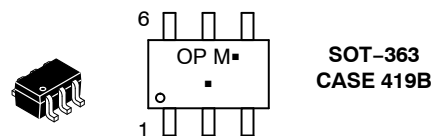

OP/J = Specific Device Code  
M = Date Code\*  
▪ = Pb-Free Package

(Note: Microdot may be in either location)

\*Date Code orientation may vary depending upon manufacturing location.

# MUN5137DW1, NSBA144WDXV6, NSBA144WDP6

## THERMAL CHARACTERISTICS

Characteristic	Symbol	Max	Unit
----------------	--------	-----	------

### MUN5137DW1 (SOT-363) One Junction Heated

Total Device Dissipation $T_A = 25^\circ\text{C}$ (Note 1) (Note 2) Derate above $25^\circ\text{C}$ (Note 1) (Note 2)	$P_D$	187 256 1.5 2.0	mW  mW/ $^\circ\text{C}$
Thermal Resistance, Junction to Ambient (Note 1) (Note 2)	$R_{\theta JA}$	670 490	$^\circ\text{C/W}$

### MUN5137DW1 (SOT-363) Both Junction Heated (Note 3)

Total Device Dissipation $T_A = 25^\circ\text{C}$ (Note 1) (Note 2) Derate above $25^\circ\text{C}$ (Note 1) (Note 2)	$P_D$	250 385 2.0 3.0	mW  mW/ $^\circ\text{C}$
Thermal Resistance, Junction to Ambient (Note 1) (Note 2)	$R_{\theta JA}$	493 325	$^\circ\text{C/W}$
Thermal Resistance, Junction to Lead (Note 1) (Note 2)	$R_{\theta JL}$	188 208	$^\circ\text{C/W}$
Junction and Storage Temperature Range	$T_J, T_{stg}$	-55 to +150	$^\circ\text{C}$

### NSBA144WDXV6 (SOT-563) One Junction Heated

Total Device Dissipation $T_A = 25^\circ\text{C}$ (Note 1) Derate above $25^\circ\text{C}$ (Note 1)	$P_D$	357 2.9	mW mW/ $^\circ\text{C}$
Thermal Resistance, Junction to Ambient (Note 1)	$R_{\theta JA}$	350	$^\circ\text{C/W}$

### NSBA144WDXV6 (SOT-563) Both Junction Heated (Note 3)

Total Device Dissipation $T_A = 25^\circ\text{C}$ (Note 1) Derate above $25^\circ\text{C}$ (Note 1)	$P_D$	500 4.0	mW mW/ $^\circ\text{C}$
Thermal Resistance, Junction to Ambient (Note 1)	$R_{\theta JA}$	250	$^\circ\text{C/W}$
Junction and Storage Temperature Range	$T_J, T_{stg}$	-55 to +150	$^\circ\text{C}$

### NSBA144WDP6 (SOT-963) One Junction Heated

Total Device Dissipation $T_A = 25^\circ\text{C}$ (Note 4) (Note 5) Derate above $25^\circ\text{C}$ (Note 4) (Note 5)	$P_D$	231 269 1.9 2.2	mW  mW/ $^\circ\text{C}$
Thermal Resistance, Junction to Ambient (Note 4) (Note 5)	$R_{\theta JA}$	540 464	$^\circ\text{C/W}$

### NSBA144WDP6 (SOT-963) Both Junction Heated (Note 3)

Total Device Dissipation $T_A = 25^\circ\text{C}$ (Note 4) (Note 5) Derate above $25^\circ\text{C}$ (Note 4) (Note 5)	$P_D$	339 408 2.7 3.3	mW  mW/ $^\circ\text{C}$
Thermal Resistance, Junction to Ambient (Note 4) (Note 5)	$R_{\theta JA}$	369 306	$^\circ\text{C/W}$
Junction and Storage Temperature Range	$T_J, T_{stg}$	-55 to +150	$^\circ\text{C}$

1. FR-4 @ Minimum Pad.
2. FR-4 @ 1.0 x 1.0 Inch Pad.
3. Both junction heated values assume total power is sum of two equally powered channels.
4. FR-4 @ 100 mm<sup>2</sup>, 1 oz. copper traces, still air.
5. FR-4 @ 500 mm<sup>2</sup>, 1 oz. copper traces, still air.

# MUN5137DW1, NSBA144WDXV6, NSBA144WDP6

## ELECTRICAL CHARACTERISTICS ( $T_A = 25^\circ\text{C}$ , common for Q<sub>1</sub> and Q<sub>2</sub>, unless otherwise noted)

Characteristic	Symbol	Min	Typ	Max	Unit
<b>OFF CHARACTERISTICS</b>					
Collector-Base Cutoff Current ( $V_{CB} = 50\text{ V}$ , $I_E = 0$ )	$I_{CBO}$	-	-	100	nAdc
Collector-Emitter Cutoff Current ( $V_{CE} = 50\text{ V}$ , $I_B = 0$ )	$I_{CEO}$	-	-	500	nAdc
Emitter-Base Cutoff Current ( $V_{EB} = 6.0\text{ V}$ , $I_C = 0$ )	$I_{EBO}$	-	-	0.13	mAdc
Collector-Base Breakdown Voltage ( $I_C = 10\ \mu\text{A}$ , $I_E = 0$ )	$V_{(BR)CBO}$	50	-	-	Vdc
Collector-Emitter Breakdown Voltage (Note 6) ( $I_C = 2.0\text{ mA}$ , $I_B = 0$ )	$V_{(BR)CEO}$	50	-	-	Vdc

## ON CHARACTERISTICS

DC Current Gain (Note 6) ( $I_C = 5.0\text{ mA}$ , $V_{CE} = 10\text{ V}$ )	$h_{FE}$	80	140	-	
Collector-Emitter Saturation Voltage (Note 6) ( $I_C = 10\text{ mA}$ , $I_B = 0.3\text{ mA}$ )	$V_{CE(sat)}$	-	-	0.25	Vdc
Input Voltage (off) ( $V_{CE} = 5.0\text{ V}$ , $I_C = 100\ \mu\text{A}$ )	$V_{i(off)}$	-	1.7	-	Vdc
Input Voltage (on) ( $V_{CE} = 0.2\text{ V}$ , $I_C = 3.0\text{ mA}$ )	$V_{i(on)}$	-	2.7	-	Vdc
Output Voltage (on) ( $V_{CC} = 5.0\text{ V}$ , $V_B = 4.0\text{ V}$ , $R_L = 1.0\text{ k}\Omega$ )	$V_{OL}$	-	-	0.2	Vdc
Output Voltage (off) ( $V_{CC} = 5.0\text{ V}$ , $V_B = 0.5\text{ V}$ , $R_L = 1.0\text{ k}\Omega$ )	$V_{OH}$	4.9	-	-	Vdc
Input Resistor	R1	32.9	47	61.1	k $\Omega$
Resistor Ratio	$R_1/R_2$	1.7	2.1	2.6	

6. Pulsed Condition: Pulse Width = 300 msec, Duty Cycle  $\leq$  2%.

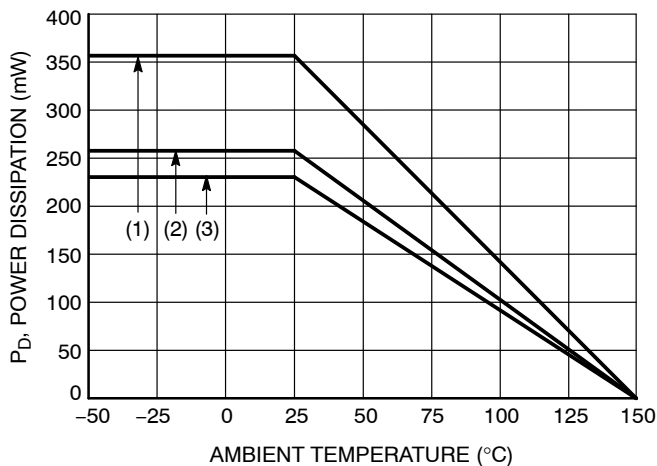

- (1) SOT-363; 1.0 x 1.0 inch Pad
- (2) SOT-563; Minimum Pad
- (3) SOT-963; 100 mm<sup>2</sup>, 1 oz. copper trace

Figure 1. Derating Curve

TYPICAL CHARACTERISTICS  
MUN5137DW1, NSBA144WDXV6

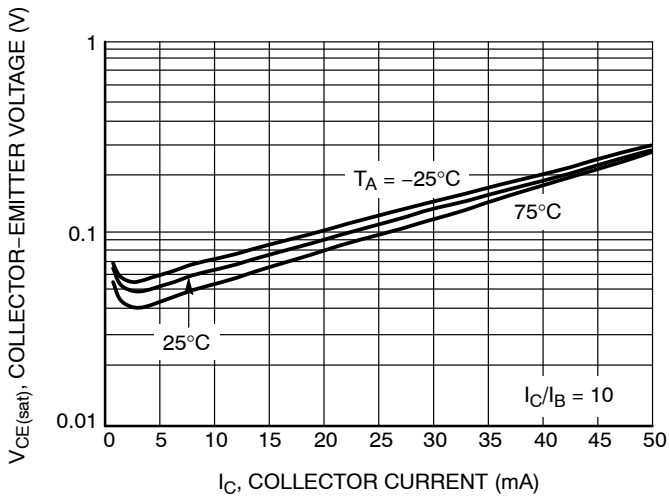

Figure 2.  $V_{CE(sat)}$  vs.  $I_C$

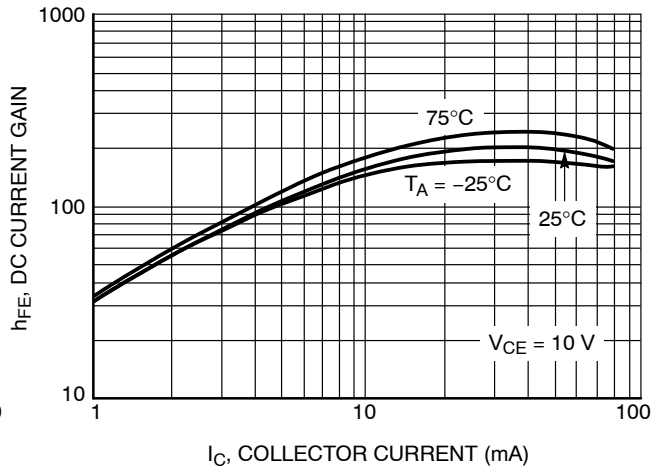

Figure 3. DC Current Gain

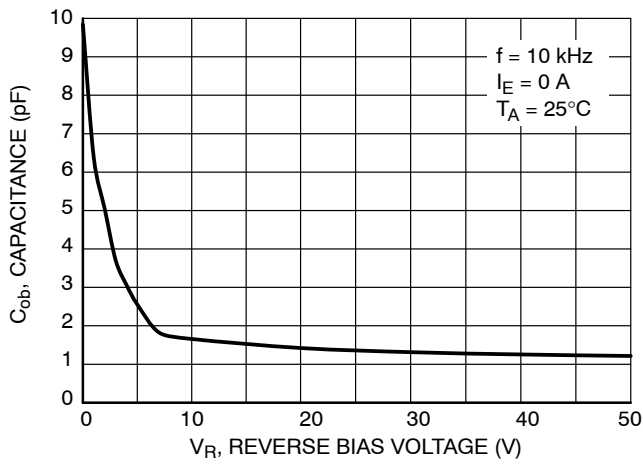

Figure 4. Output Capacitance

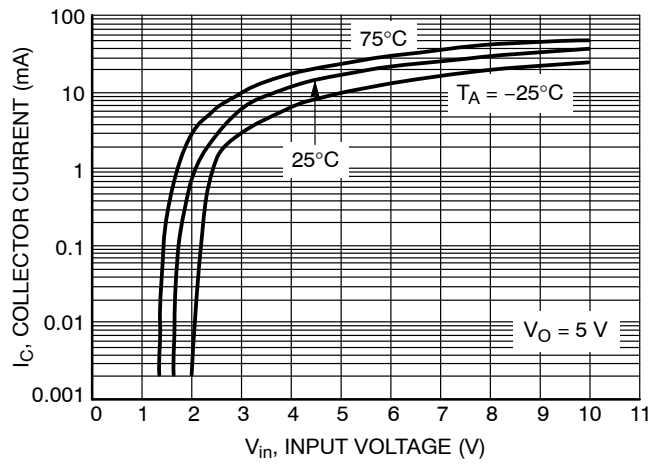

Figure 5. Output Current vs. Input Voltage

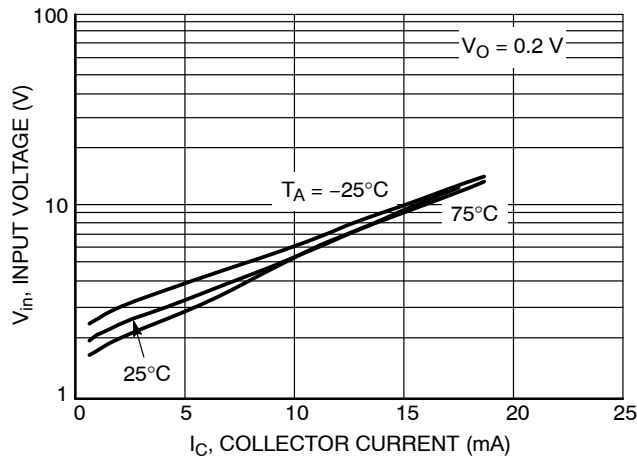

Figure 6. Input Voltage vs. Output Current

TYPICAL CHARACTERISTICS  
NSBA144WDP6

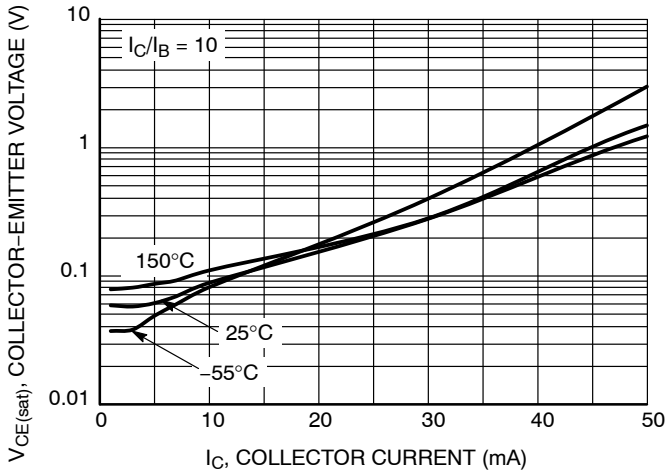

Figure 7.  $V_{CE(sat)}$  vs.  $I_C$

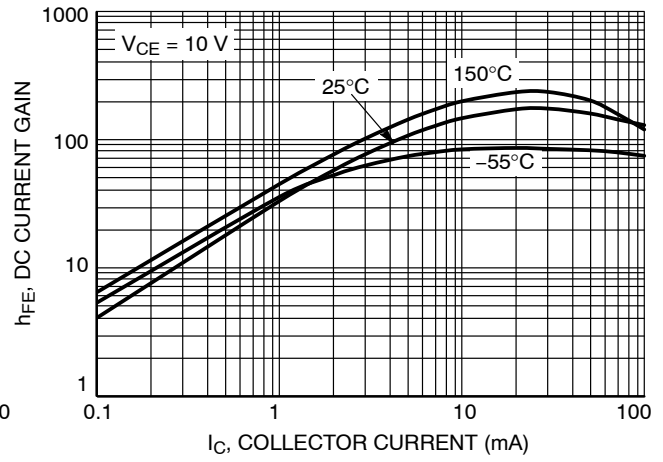

Figure 8. DC Current Gain

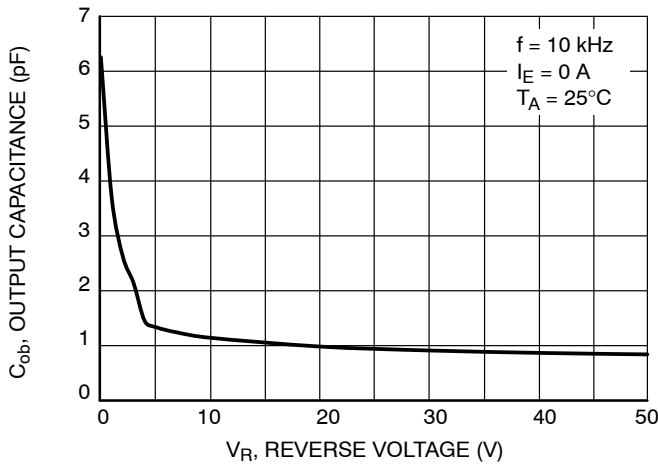

Figure 9. Output Capacitance

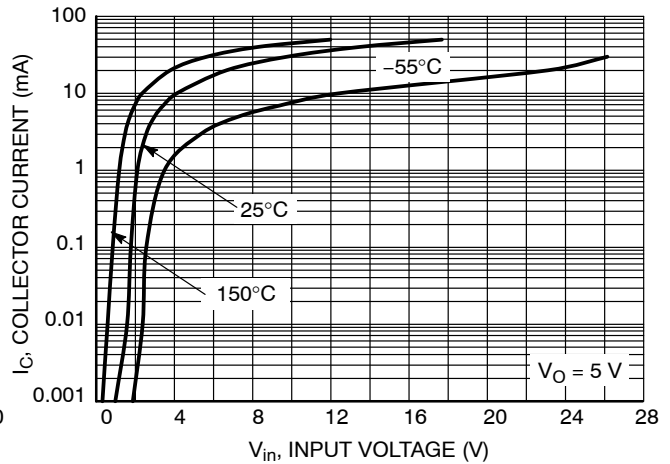

Figure 10. Output Current vs. Input Voltage

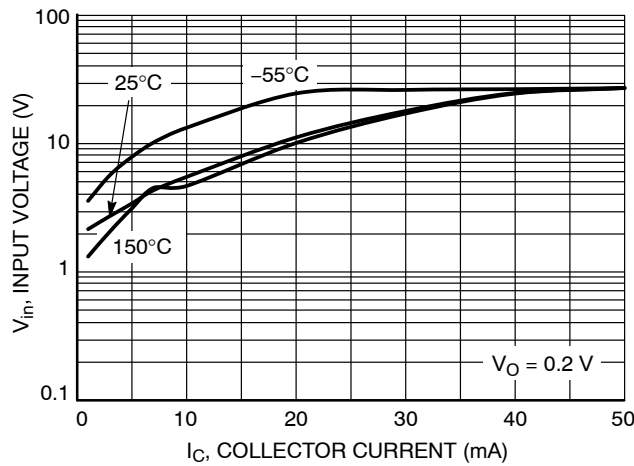
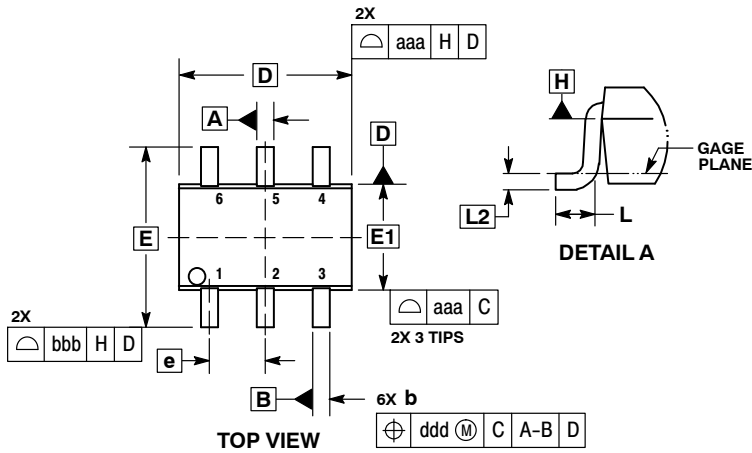

Figure 11. Input Voltage vs. Output Current

# MUN5137DW1, NSBA144WDXV6, NSBA144WDP6

## PACKAGE DIMENSIONS

SC-88/SC70-6/SOT-363  
CASE 419B-02  
ISSUE Y



- NOTES:
1. DIMENSIONING AND TOLERANCING PER ASME Y14.5M, 1994.
  2. CONTROLLING DIMENSION: MILLIMETERS.
  3. DIMENSIONS D AND E1 DO NOT INCLUDE MOLD FLASH, PROTRUSIONS, OR GATE BURRS. MOLD FLASH, PROTRUSIONS, OR GATE BURRS SHALL NOT EXCEED 0.20 PER END.
  4. DIMENSIONS D AND E1 AT THE OUTERMOST EXTREMES OF THE PLASTIC BODY AND DATUM H.
  5. DATUMS A AND B ARE DETERMINED AT DATUM H.
  6. DIMENSIONS b AND c APPLY TO THE FLAT SECTION OF THE LEAD BETWEEN 0.08 AND 0.15 FROM THE TIP.
  7. DIMENSION b DOES NOT INCLUDE DAMBAR PROTRUSION. ALLOWABLE DAMBAR PROTRUSION SHALL BE 0.08 TOTAL IN EXCESS OF DIMENSION b AT MAXIMUM MATERIAL CONDITION. THE DAMBAR CANNOT BE LOCATED ON THE LOWER RADIUS OF THE FOOT.

DIM	MILLIMETERS			INCHES		
	MIN	NOM	MAX	MIN	NOM	MAX
A	---	---	1.10	---	---	0.043
A1	0.00	---	0.10	0.000	---	0.004
A2	0.70	0.90	1.00	0.027	0.035	0.039
b	0.15	0.20	0.25	0.006	0.008	0.010
C	0.08	0.15	0.22	0.003	0.006	0.009
D	1.80	2.00	2.20	0.070	0.078	0.086
E	2.00	2.10	2.20	0.078	0.082	0.086
E1	1.15	1.25	1.35	0.045	0.049	0.053
e	0.65 BSC			0.026 BSC		
L	0.26	0.36	0.46	0.010	0.014	0.018
L2	0.15 BSC			0.006 BSC		
aaa	0.15			0.006		
bbb	0.30			0.012		
ccc	0.10			0.004		
ddd	0.10			0.004		

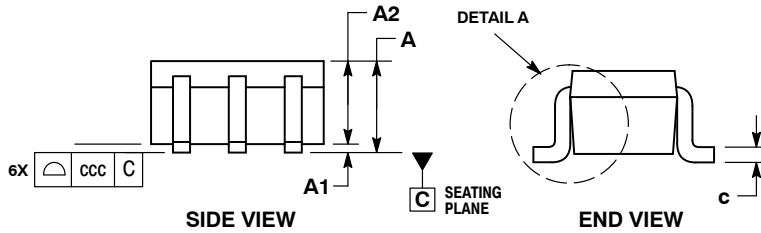

### RECOMMENDED SOLDERING FOOTPRINT\*

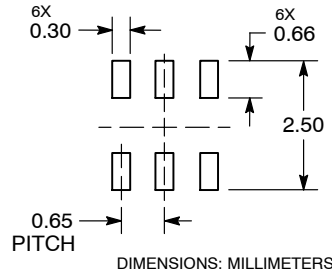

\*For additional information on our Pb-Free strategy and soldering details, please download the ON Semiconductor Soldering and Mounting Techniques Reference Manual, SOLDERRM/D.

# MUN5137DW1, NSBA144WDXV6, NSBA144WDP6

## PACKAGE DIMENSIONS

### SOT-563, 6 LEAD CASE 463A ISSUE G

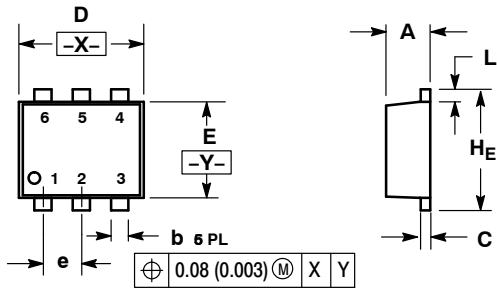

NOTES:

1. DIMENSIONING AND TOLERANCING PER ANSI Y14.5M, 1982.
2. CONTROLLING DIMENSION: MILLIMETERS
3. MAXIMUM LEAD THICKNESS INCLUDES LEAD FINISH THICKNESS. MINIMUM LEAD THICKNESS IS THE MINIMUM THICKNESS OF BASE MATERIAL.

DIM	MILLIMETERS			INCHES		
	MIN	NOM	MAX	MIN	NOM	MAX
A	0.50	0.55	0.60	0.020	0.021	0.023
b	0.17	0.22	0.27	0.007	0.009	0.011
C	0.08	0.12	0.18	0.003	0.005	0.007
D	1.50	1.60	1.70	0.059	0.062	0.066
E	1.10	1.20	1.30	0.043	0.047	0.051
e	0.5 BSC			0.02 BSC		
L	0.10	0.20	0.30	0.004	0.008	0.012
H <sub>E</sub>	1.50	1.60	1.70	0.059	0.062	0.066

### SOLDERING FOOTPRINT\*

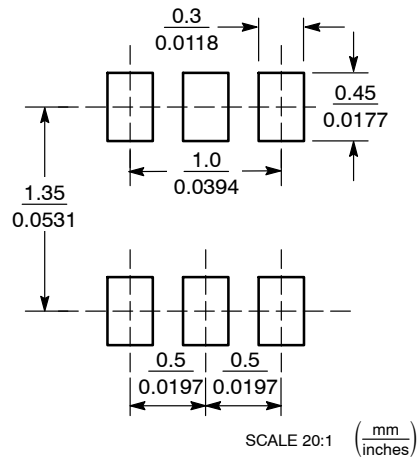

\*For additional information on our Pb-Free strategy and soldering details, please download the ON Semiconductor Soldering and Mounting Techniques Reference Manual, SOLDERRM/D.



# MUN5137DW1, NSBA144WDXV6, NSBA144WDP6

## PACKAGE DIMENSIONS

**SOT-963**  
CASE 527AD  
ISSUE E

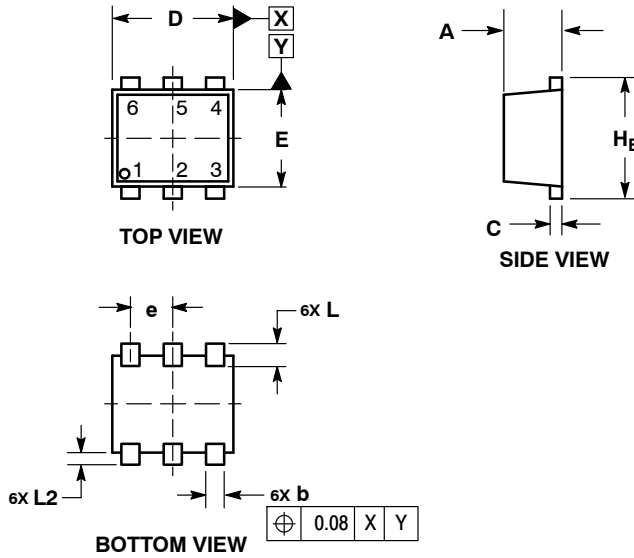

**NOTES:**

1. DIMENSIONING AND TOLERANCING PER ASME Y14.5M, 1994.
2. CONTROLLING DIMENSION: MILLIMETERS
3. MAXIMUM LEAD THICKNESS INCLUDES LEAD FINISH THICKNESS. MINIMUM LEAD THICKNESS IS THE MINIMUM THICKNESS OF BASE MATERIAL.
4. DIMENSIONS D AND E DO NOT INCLUDE MOLD FLASH, PROTRUSIONS, OR GATE BURRS.

DIM	MILLIMETERS		
	MIN	NOM	MAX
A	0.34	0.37	0.40
b	0.10	0.15	0.20
C	0.07	0.12	0.17
D	0.95	1.00	1.05
E	0.75	0.80	0.85
e	0.35 BSC		
H <sub>E</sub>	0.95	1.00	1.05
L	0.19 REF		
L2	0.05	0.10	0.15

### RECOMMENDED MOUNTING FOOTPRINT

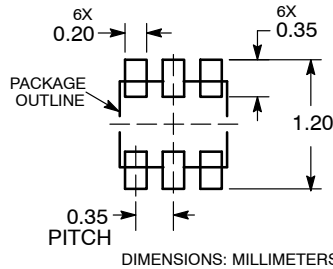

ON Semiconductor and are trademarks of Semiconductor Components Industries, LLC dba ON Semiconductor or its subsidiaries in the United States and/or other countries. ON Semiconductor owns the rights to a number of patents, trademarks, copyrights, trade secrets, and other intellectual property. A listing of ON Semiconductor's product/patent coverage may be accessed at [www.onsemi.com/site/pdf/Patent-Marking.pdf](http://www.onsemi.com/site/pdf/Patent-Marking.pdf). ON Semiconductor reserves the right to make changes without further notice to any products herein. ON Semiconductor makes no warranty, representation or guarantee regarding the suitability of its products for any particular purpose, nor does ON Semiconductor assume any liability arising out of the application or use of any product or circuit, and specifically disclaims any and all liability, including without limitation special, consequential or incidental damages. Buyer is responsible for its products and applications using ON Semiconductor products, including compliance with all laws, regulations and safety requirements or standards, regardless of any support or applications information provided by ON Semiconductor. "Typical" parameters which may be provided in ON Semiconductor data sheets and/or specifications can and do vary in different applications and actual performance may vary over time. All operating parameters, including "Typicals" must be validated for each customer application by customer's technical experts. ON Semiconductor does not convey any license under its patent rights nor the rights of others. ON Semiconductor products are not designed, intended, or authorized for use as a critical component in life support systems or any FDA Class 3 medical devices or medical devices with a same or similar classification in a foreign jurisdiction or any devices intended for implantation in the human body. Should Buyer purchase or use ON Semiconductor products for any such unintended or unauthorized application, Buyer shall indemnify and hold ON Semiconductor and its officers, employees, subsidiaries, affiliates, and distributors harmless against all claims, costs, damages, and expenses, and reasonable attorney fees arising out of, directly or indirectly, any claim of personal injury or death associated with such unintended or unauthorized use, even if such claim alleges that ON Semiconductor was negligent regarding the design or manufacture of the part. ON Semiconductor is an Equal Opportunity/Affirmative Action Employer. This literature is subject to all applicable copyright laws and is not for resale in any manner.

### PUBLICATION ORDERING INFORMATION

**LITERATURE FULFILLMENT:**

Literature Distribution Center for ON Semiconductor  
19521 E. 32nd Pkwy, Aurora, Colorado 80011 USA  
Phone: 303-675-2175 or 800-344-3860 Toll Free USA/Canada  
Fax: 303-675-2176 or 800-344-3867 Toll Free USA/Canada  
Email: [orderlit@onsemi.com](mailto:orderlit@onsemi.com)

**N. American Technical Support:** 800-282-9855 Toll Free  
USA/Canada  
**Europe, Middle East and Africa Technical Support:**  
Phone: 421 33 790 2910  
**Japan Customer Focus Center**  
Phone: 81-3-5817-1050

**ON Semiconductor Website:** [www.onsemi.com](http://www.onsemi.com)

**Order Literature:** <http://www.onsemi.com/orderlit>

For additional information, please contact your local Sales Representative