



Chipsmall Limited consists of a professional team with an average of over 10 year of expertise in the distribution of electronic components. Based in Hongkong, we have already established firm and mutual-benefit business relationships with customers from,Europe,America and south Asia,supplying obsolete and hard-to-find components to meet their specific needs.

With the principle of “Quality Parts,Customers Priority,Honest Operation,and Considerate Service”,our business mainly focus on the distribution of electronic components. Line cards we deal with include Microchip,ALPS,ROHM,Xilinx,Pulse,ON,Everlight and Freescale. Main products comprise IC,Modules,Potentiometer,IC Socket,Relay,Connector.Our parts cover such applications as commercial,industrial, and automotives areas.

We are looking forward to setting up business relationship with you and hope to provide you with the best service and solution. Let us make a better world for our industry!



## Contact us

Tel: +86-755-8981 8866 Fax: +86-755-8427 6832

Email & Skype: info@chipsmall.com Web: www.chipsmall.com

Address: A1208, Overseas Decoration Building, #122 Zhenhua RD., Futian, Shenzhen, China



# NSVF4009SG4

## RF Transistor for Low Noise Amplifier

This RF transistor is designed for low noise amplifier applications. MCPH package is suitable for use under high temperature environment because it has superior heat radiation characteristics. This RF transistor is AEC-Q101 qualified and PPAP capable for automotive applications.

### Features

- Low-noise use : NF = 1.1 dB typ. (f = 2 GHz)
- High cut-off frequency :  $f_T = 25$  GHz typ. ( $V_{CE} = 3$  V)
- Low operating voltage
- High gain :  $|S_{21e}|^2 = 17$  dB typ. (f = 2 GHz)
- AEC-Q101 qualified and PPAP capable
- MCPH4 package is pin-compatible with SC-82FL
- Pb-Free, Halogen Free and RoHS compliance

### Typical Applications

- Low Noise Amplifier for Satellite Radio
- Low Noise Amplifier for GPS

### SPECIFICATIONS

#### ABSOLUTE MAXIMUM RATING at $T_a = 25^\circ\text{C}$ (Note 1)

Parameter	Symbol	Value	Unit
Collector to Base Voltage	$V_{CBO}$	10	V
Collector to Emitter Voltage	$V_{CEO}$	3.5	V
Emitter to Base Voltage	$V_{EBO}$	2.5	V
Collector Current	$I_C$	40	mA
Collector Dissipation	$P_C$	120	mW
Operating Junction and Storage Temperature	$T_j, T_{stg}$	-55 to +150	$^\circ\text{C}$

Note 1 : Stresses exceeding those listed in the Maximum Ratings table may damage the device. If any of these limits are exceeded, device functionality should not be assumed, damage may occur and reliability may be affected.



ON Semiconductor®

www.onsemi.com

3.5 V, 40 mA  
 $f_T = 25$  GHz typ.  
RF Transistor

### ELECTRICAL CONNECTION NPN

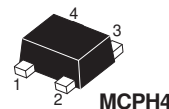
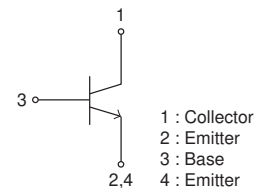

### MARKING

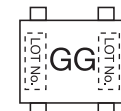

### ORDERING INFORMATION

See detailed ordering and shipping information on page 14 of this data sheet.

# NSVF4009SG4

## ELECTRICAL CHARACTERISTICS at Ta = 25°C (Note 2)

Parameter	Symbol	Conditions	Value			Unit
			min	typ	max	
Collector Cutoff Current	ICBO	V <sub>CB</sub> = 5 V, I <sub>E</sub> = 0 A			1.0	μA
Emitter Cutoff Current	IEBO	V <sub>EB</sub> = 1 V, I <sub>C</sub> = 0 A			1.0	μA
DC Current Gain	hFE	V <sub>CE</sub> = 1 V, I <sub>C</sub> = 5 mA	50		120	
Gain-Bandwidth Product	f <sub>T</sub>	V <sub>CE</sub> = 3 V, I <sub>C</sub> = 20 mA	20	25		GHz
Reverse Transfer Capacitance	C <sub>re</sub>	V <sub>CB</sub> = 1 V, f = 1 MHz		0.15		pF
Forward Transfer Gain	S <sub>21e</sub>   <sup>2</sup> <sub>1</sub>	V <sub>CE</sub> = 1 V, I <sub>C</sub> = 5 mA, f = 2 GHz	9	13.5		dB
	S <sub>21e</sub>   <sup>2</sup> <sub>2</sub>	V <sub>CE</sub> = 3 V, I <sub>C</sub> = 20 mA, f = 2 GHz		17		dB
Noise Figure	NF	V <sub>CE</sub> = 1 V, I <sub>C</sub> = 5 mA, f = 2 GHz		1.1	1.5	dB
1dB Compression Point	PO(1dB)	V <sub>CE</sub> = 3 V, I <sub>C</sub> = 20 mA, f = 2 GHz		13.5		dBm
3rd Order Intercept Point	OIP <sub>3</sub>	V <sub>CE</sub> = 3 V, I <sub>C</sub> = 20 mA, f = 2 GHz		23		dBm

Note 2 : Product parametric performance is indicated in the Electrical Characteristics for the listed test conditions, unless otherwise noted.

Product performance may not be indicated by the Electrical Characteristics if operated under different conditions.

Note 3 : Pay attention to handling since it is liable to be affected by static electricity due to the high-frequency process adopted.

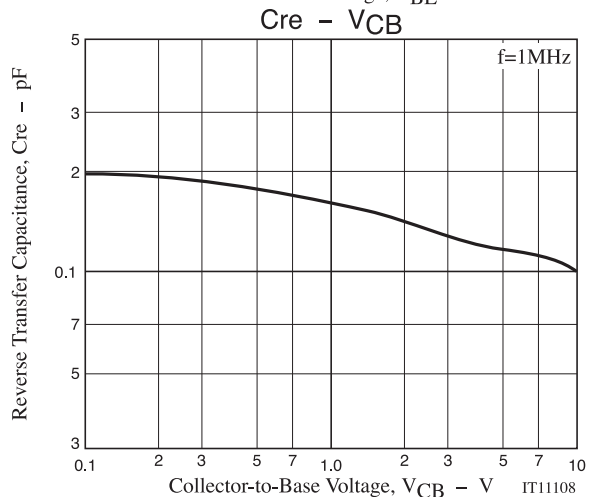
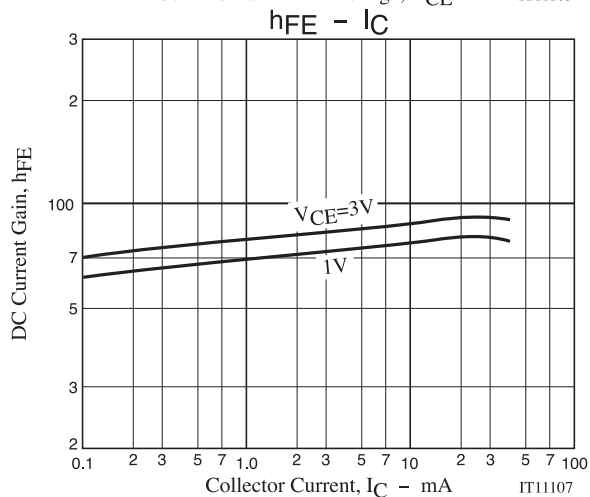
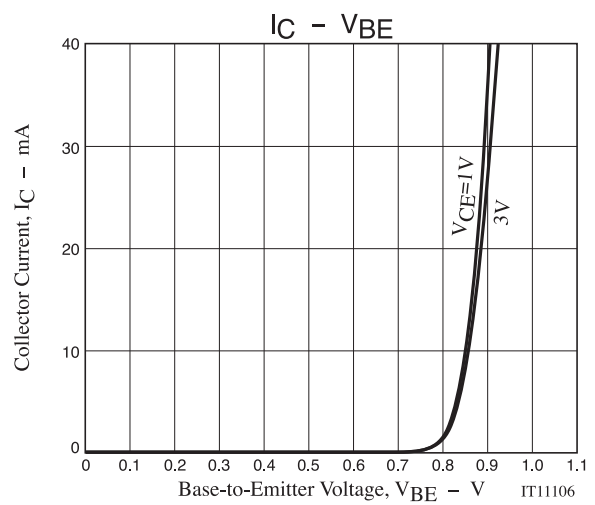
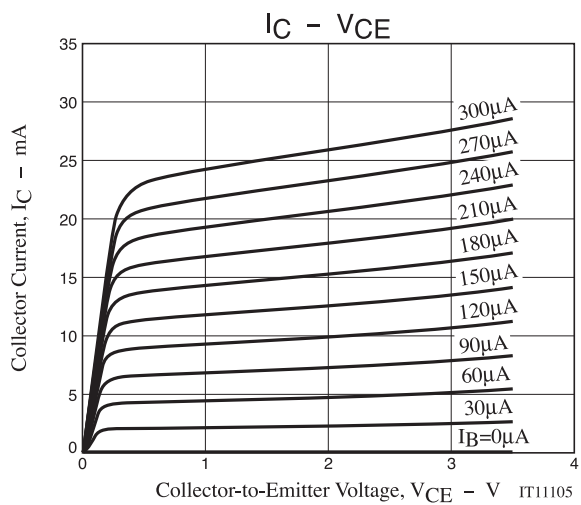

# NSVF4009SG4

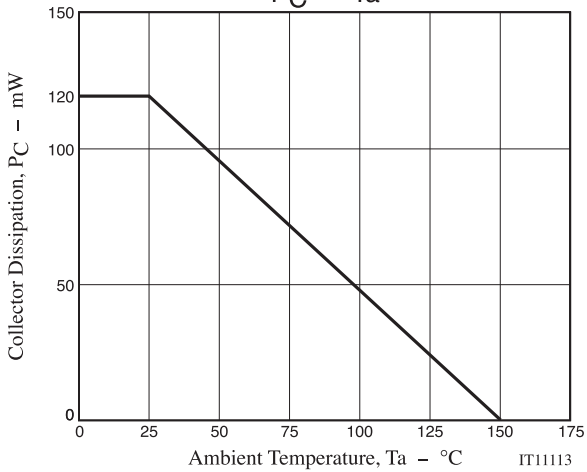
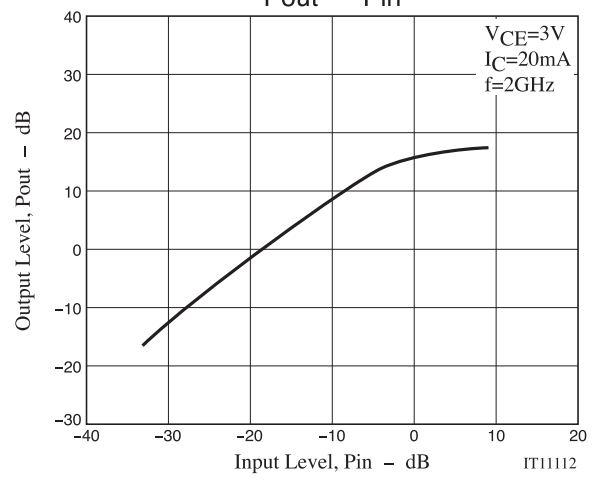
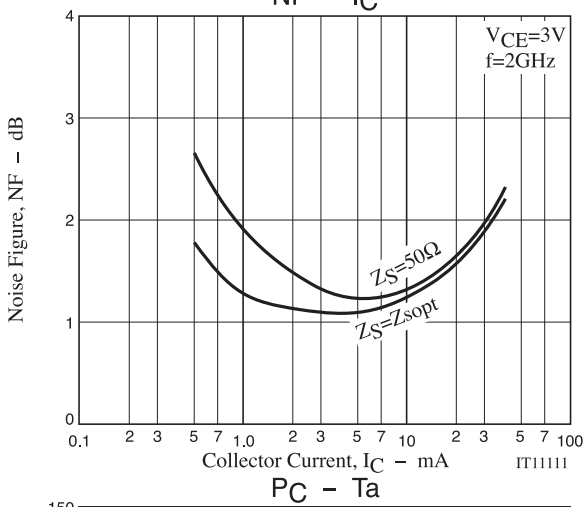
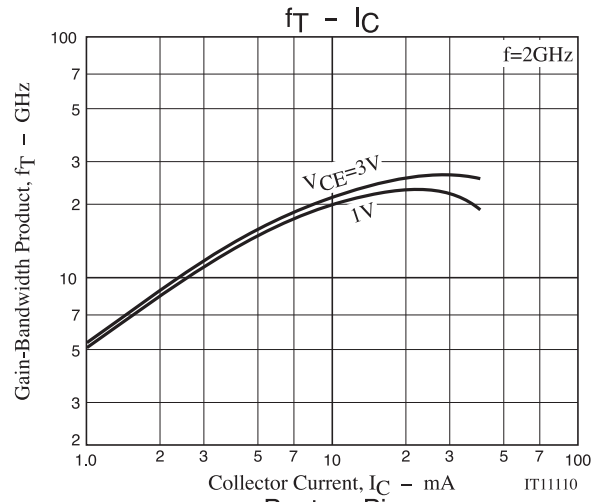
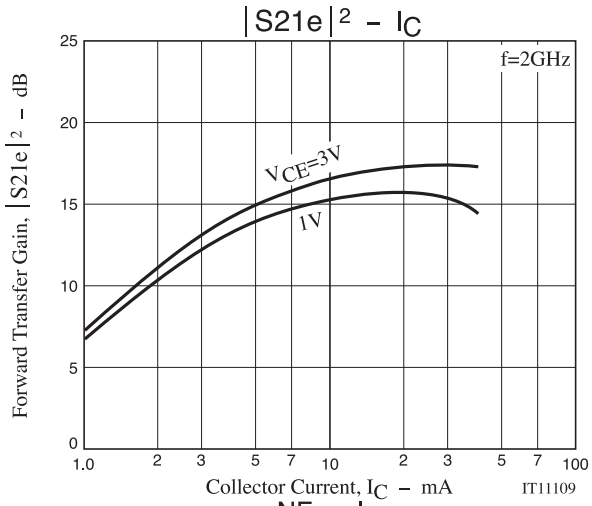



# NSVF4009SG4

## SPICE Parameters

model: Gummel-Poon

Parameter	Value	Unit	Parameter	Value	Unit
IS	38.78a	A	XTF	11.00f	
BF	107.6		VTF	81.1	V
NF	1.002		ITF	1.55	A
VAF	34.79	V	PTF	32	°C
IKF	199.6m	A	CJC	214.0f	F
ISE	138.1f	A	VJC	111.7m	V
NE	2.5		MJC	118.0m	
BR	1.5		XCJC	833.8m	
NR	1.05		TR	50.00p	S
VAR	200	V	FC	8.105m	
IKR	20.00μ	A	CJS	123.2f	F
ISC	0	A	VJS	140.0f	V
NC	2		MJS	150	
RB	8.5	Ω	Lwb	415p	H
IRB	143.2m	A	Llb	210p	H
RBM	1.584	Ω	Lwe	243.6p	H
RE	1.022	Ω	Lle	12.8p	H
RC	3.675	Ω	Lwc	330p	H
XTB	0		Llc	651.5p	H
EG	1.11	eV	Ccb	26.7f	F
XTI	3		Cec1	185.4f	F
CJE	250.0f	F	Cec2	40f	F
VJE	23.00m	V	Cbe1	65f	F
MJE	21.60m		Cbe2	25.2f	F
TF	5.398p	S			

## Schematic

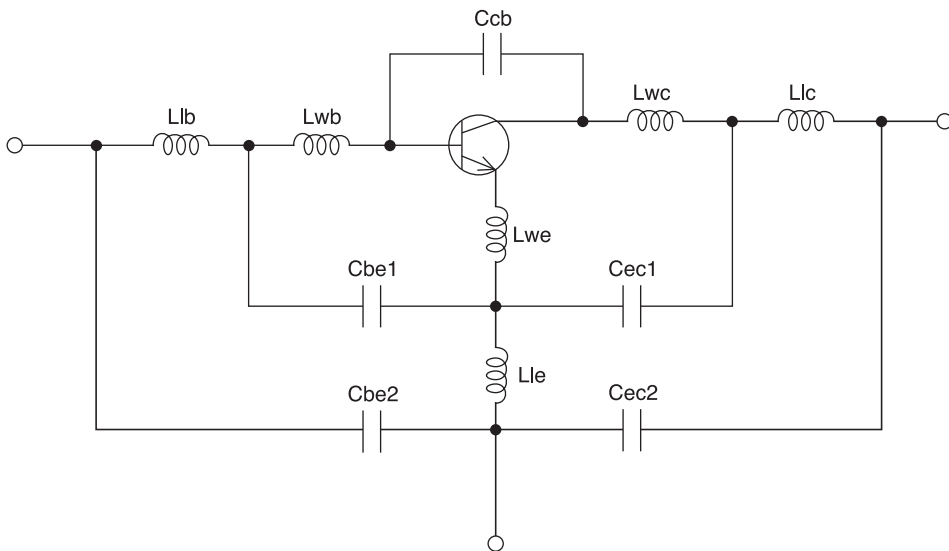

IT11114

\*Information (including circuit diagrams and circuit parameters) herein is for example only ; it is not guaranteed for volume production.

# NSVF4009SG4

## S Parameters (Common emitter)

V<sub>CE</sub>=1V, I<sub>C</sub>=5mA

Freq(MHz)	S11	∠S11	S21	∠S21	S12	∠S12	S22	∠S22
500	0.801	-49.4	10.891	140.0	0.046	63.0	0.783	-36.9
1000	0.662	-87.0	8.137	115.4	0.071	46.0	0.571	-58.5
1500	0.567	-113.5	6.269	98.7	0.083	37.4	0.431	-72.5
2000	0.521	-131.1	4.982	86.7	0.091	32.9	0.346	-82.4
2500	0.479	-147.7	4.152	77.3	0.097	30.1	0.294	-91.0
3000	0.461	-160.2	3.534	68.0	0.102	28.1	0.253	-95.9
3500	0.454	-170.5	3.096	60.2	0.107	27.1	0.223	-100.3
4000	0.450	-179.1	2.762	52.9	0.113	25.3	0.201	-103.1
4500	0.445	173.1	2.524	45.8	0.120	24.0	0.178	-106.4
5000	0.437	165.9	2.327	38.7	0.127	21.9	0.161	-109.5
5500	0.426	158.4	2.132	32.0	0.135	18.9	0.161	-112.6
6000	0.409	147.6	2.059	24.2	0.143	16.1	0.130	-124.6
6500	0.401	135.5	1.948	16.5	0.152	12.1	0.121	-137.7
7000	0.408	121.5	1.840	8.4	0.157	7.8	0.117	-154.8
7500	0.435	108.4	1.725	0.5	0.161	3.3	0.117	-171.6
8000	0.466	97.5	1.613	-7.2	0.164	-0.9	0.112	168.6
8500	0.509	90.3	1.513	-14.4	0.168	-5.5	0.114	148.9
9000	0.541	84.6	1.412	-21.3	0.169	-9.8	0.117	127.8
9500	0.568	80.7	1.338	-27.7	0.172	-13.7	0.132	107.8
10000	0.588	75.4	1.276	-34.8	0.175	-18.9	0.164	91.3
10500	0.599	70.5	1.213	-42.0	0.173	-24.2	0.201	82.3
11000	0.610	60.8	1.150	-49.4	0.176	-29.9	0.240	77.0
11500	0.622	51.5	1.093	-57.0	0.177	-36.1	0.275	74.3
12000	0.653	41.6	1.029	-65.3	0.172	-42.7	0.311	70.8
12500	0.687	33.1	0.959	-72.8	0.167	-48.5	0.331	67.0
13000	0.711	27.0	0.886	-80.1	0.161	-53.6	0.347	60.4
13500	0.741	23.6	0.824	-86.4	0.158	-58.4	0.351	52.6
14000	0.757	22.1	0.774	-92.9	0.154	-63.4	0.364	42.7
14500	0.757	20.6	0.725	-98.7	0.157	-67.6	0.382	33.0
15000	0.758	19.4	0.684	-104.8	0.159	-73.0	0.404	27.4

# NSVF4009SG4

## S Parameters (Common emitter)

V<sub>CE</sub>=1V, I<sub>C</sub>=10mA

Freq(MHz)	S11	∠S11	S21	∠S21	S12	∠S12	S22	∠S22
500	0.665	-68.4	16.105	129.6	0.040	58.4	0.676	-48.9
1000	0.536	-109.6	10.494	105.3	0.056	46.4	0.437	-72.8
1500	0.475	-134.8	7.518	90.9	0.067	42.6	0.310	-87.7
2000	0.448	-150.5	5.820	80.6	0.076	41.3	0.240	-98.9
2500	0.428	-164.9	4.763	72.3	0.085	40.3	0.200	-108.1
3000	0.421	-175.6	4.030	64.4	0.094	39.2	0.167	-114.4
3500	0.419	175.8	3.511	57.3	0.104	37.4	0.141	-119.4
4000	0.418	168.6	3.130	50.5	0.113	35.3	0.120	-122.6
4500	0.416	162.1	2.843	43.9	0.122	32.9	0.098	-126.9
5000	0.409	155.7	2.616	37.1	0.132	30.1	0.082	-130.0
5500	0.398	148.7	2.430	30.6	0.143	26.7	0.074	-132.1
6000	0.387	138.2	2.296	23.2	0.153	22.4	0.061	-154.0
6500	0.385	126.4	2.162	15.8	0.162	17.6	0.066	-174.5
7000	0.399	113.2	2.034	8.0	0.169	12.6	0.078	163.9
7500	0.429	101.2	1.904	0.5	0.174	7.4	0.094	147.2
8000	0.463	91.5	1.774	-6.8	0.178	2.7	0.110	128.3
8500	0.506	85.3	1.661	-13.7	0.181	-2.2	0.128	112.1
9000	0.538	80.6	1.555	-20.5	0.183	-7.1	0.148	95.7
9500	0.566	77.1	1.473	-26.6	0.187	-11.8	0.174	82.1
10000	0.586	72.4	1.395	-33.5	0.188	-17.1	0.211	72.4
10500	0.596	67.5	1.327	-40.3	0.187	-22.4	0.249	66.3
11000	0.611	58.0	1.261	-47.4	0.188	-28.5	0.282	63.3
11500	0.623	48.9	1.199	-54.8	0.188	-34.8	0.312	61.6
12000	0.654	39.3	1.131	-62.7	0.183	-41.8	0.345	59.4
12500	0.691	31.0	1.056	-70.1	0.177	-47.7	0.361	55.5
13000	0.715	25.2	0.978	-77.2	0.172	-52.7	0.375	49.4
13500	0.744	22.0	0.912	-83.5	0.169	-57.4	0.380	41.4
14000	0.756	20.6	0.859	-89.6	0.167	-62.0	0.394	32.0
14500	0.759	19.4	0.808	-95.4	0.168	-67.2	0.410	23.1
15000	0.756	18.1	0.774	-101.1	0.171	-72.6	0.428	16.9

# NSVF4009SG4

## S Parameters (Common emitter)

V<sub>CE</sub>=1V, I<sub>C</sub>=20mA

Freq(MHz)	S11	∠S11	S21	∠S21	S12	∠S12	S22	∠S22
500	0.537	-90.6	19.515	119.9	0.033	56.6	0.560	-60.3
1000	0.463	-131.2	11.501	98.0	0.047	50.3	0.333	-86.0
1500	0.437	-152.5	7.973	85.6	0.058	49.6	0.233	-102.7
2000	0.425	-165.4	6.106	76.7	0.070	49.8	0.179	-116.2
2500	0.417	-177.7	4.959	69.1	0.081	48.1	0.149	-127.4
3000	0.416	173.4	4.188	61.8	0.093	46.1	0.126	-136.7
3500	0.417	166.1	3.640	55.1	0.104	43.9	0.104	-144.6
4000	0.417	159.8	3.241	48.6	0.115	41.2	0.086	-151.3
4500	0.416	154.1	2.933	42.2	0.127	38.2	0.068	-162.2
5000	0.408	148.1	2.702	35.7	0.138	34.3	0.053	-173.4
5500	0.398	141.4	2.526	29.3	0.148	30.1	0.044	176.8
6000	0.391	131.4	2.359	22.1	0.160	25.4	0.051	150.8
6500	0.392	119.9	2.216	14.7	0.169	20.1	0.068	139.9
7000	0.410	107.5	2.078	7.1	0.177	15.0	0.091	130.4
7500	0.442	96.4	1.944	-0.2	0.181	9.3	0.112	120.9
8000	0.478	87.6	1.804	-7.5	0.187	4.2	0.136	108.3
8500	0.520	81.9	1.687	-14.1	0.188	-0.9	0.161	96.9
9000	0.550	77.7	1.579	-20.7	0.191	-6.0	0.186	83.7
9500	0.576	74.5	1.497	-26.6	0.194	-10.9	0.215	73.0
10000	0.596	69.9	1.411	-33.4	0.195	-16.4	0.252	65.4
10500	0.607	65.3	1.345	-40.0	0.195	-21.5	0.288	60.1
11000	0.623	56.0	1.276	-47.0	0.195	-27.9	0.320	57.3
11500	0.635	47.0	1.214	-54.2	0.195	-34.3	0.346	55.8
12000	0.666	37.5	1.146	-62.0	0.190	-41.3	0.375	53.5
12500	0.700	29.5	1.068	-69.1	0.183	-46.7	0.391	49.9
13000	0.725	23.9	0.990	-76.1	0.176	-52.1	0.405	43.7
13500	0.752	21.0	0.923	-82.2	0.175	-56.9	0.409	36.0
14000	0.766	19.6	0.869	-88.3	0.171	-61.8	0.423	26.6
14500	0.765	18.3	0.816	-94.0	0.172	-66.5	0.439	18.2
15000	0.763	17.1	0.794	-99.4	0.176	-71.9	0.455	12.0



# NSVF4009SG4

## S Parameters (Common emitter)

V<sub>CE</sub>=1V, I<sub>C</sub>=30mA

Freq(MHz)	S11	∠S11	S21	∠S21	S12	∠S12	S22	∠S22
500	0.489	-105.9	19.643	115.2	0.031	55.0	0.490	-66.6
1000	0.453	-142.8	11.260	94.8	0.044	52.3	0.286	-93.3
1500	0.441	-161.4	7.725	83.4	0.056	52.4	0.202	-111.9
2000	0.435	-172.7	5.906	74.8	0.068	52.5	0.158	-126.9
2500	0.432	176.2	4.789	67.3	0.082	50.9	0.135	-139.4
3000	0.433	168.2	4.041	60.3	0.094	48.4	0.117	-149.3
3500	0.435	161.4	3.509	53.7	0.105	46.0	0.099	-159.4
4000	0.434	155.5	3.125	47.3	0.117	43.0	0.083	-168.8
4500	0.433	150.1	2.821	40.9	0.129	39.6	0.069	176.7
5000	0.426	144.2	2.604	34.4	0.140	35.6	0.059	161.8
5500	0.415	137.6	2.447	28.0	0.151	31.5	0.052	150.0
6000	0.411	127.7	2.271	20.7	0.163	26.3	0.065	132.1
6500	0.413	116.6	2.129	13.3	0.173	20.9	0.083	126.0
7000	0.432	104.5	1.989	5.7	0.180	15.3	0.108	119.9
7500	0.465	93.9	1.860	-1.6	0.186	9.8	0.129	112.7
8000	0.500	85.4	1.723	-8.7	0.189	4.4	0.155	102.6
8500	0.541	80.1	1.608	-15.5	0.192	-0.5	0.181	92.0
9000	0.569	76.0	1.506	-21.8	0.194	-5.8	0.206	80.5
9500	0.594	72.9	1.428	-27.7	0.197	-10.6	0.235	70.8
10000	0.613	68.4	1.342	-34.5	0.199	-16.4	0.272	63.4
10500	0.622	63.8	1.280	-41.0	0.197	-21.3	0.308	58.2
11000	0.638	54.6	1.215	-47.9	0.197	-27.7	0.338	55.5
11500	0.650	45.6	1.155	-55.1	0.198	-34.2	0.364	53.8
12000	0.682	36.4	1.088	-62.7	0.192	-41.3	0.392	51.6
12500	0.715	28.4	1.013	-69.8	0.185	-46.9	0.406	47.7
13000	0.736	23.0	0.938	-76.7	0.179	-52.2	0.420	41.5
13500	0.760	20.1	0.872	-82.6	0.177	-57.0	0.424	34.2
14000	0.772	18.9	0.822	-88.7	0.173	-61.9	0.440	25.2
14500	0.773	17.5	0.773	-94.1	0.174	-66.2	0.452	16.9
15000	0.771	16.3	0.756	-99.3	0.177	-71.7	0.470	10.3

# NSVF4009SG4

## S Parameters (Common emitter)

V<sub>CE</sub>=3V, I<sub>C</sub>=5mA

Freq(MHz)	S11	∠S11	S21	∠S21	S12	∠S12	S22	∠S22
500	0.832	-42.0	11.342	143.7	0.035	67.9	0.835	-29.1
1000	0.693	-76.2	8.817	119.7	0.057	52.4	0.646	-47.2
1500	0.581	-101.6	6.951	102.7	0.068	42.9	0.507	-58.3
2000	0.519	-119.3	5.587	90.5	0.076	37.6	0.420	-65.5
2500	0.465	-135.9	4.695	80.9	0.081	35.3	0.364	-71.4
3000	0.436	-149.0	3.997	71.6	0.085	33.3	0.327	-74.4
3500	0.422	-160.1	3.507	63.8	0.090	32.4	0.300	-77.0
4000	0.414	-169.2	3.129	56.6	0.096	31.1	0.284	-78.7
4500	0.406	-177.3	2.861	49.6	0.101	30.6	0.266	-80.3
5000	0.395	-175.4	2.637	42.7	0.107	29.0	0.255	-82.3
5500	0.383	-168.1	2.397	36.3	0.114	26.4	0.257	-86.0
6000	0.359	-157.5	2.340	28.9	0.122	23.8	0.227	-90.3
6500	0.345	-145.1	2.218	21.4	0.130	20.8	0.215	-97.8
7000	0.347	-130.0	2.105	13.5	0.137	16.9	0.201	-107.2
7500	0.370	-115.2	1.981	5.8	0.141	12.7	0.188	-117.5
8000	0.400	-103.2	1.865	-1.8	0.145	8.7	0.168	-126.7
8500	0.444	-95.1	1.756	-9.0	0.151	5.1	0.147	-137.3
9000	0.480	-89.2	1.645	-16.0	0.153	0.6	0.120	-148.1
9500	0.510	-85.2	1.566	-22.3	0.157	-3.0	0.093	-163.7
10000	0.531	-79.9	1.507	-29.4	0.162	-7.8	0.075	-165.4
10500	0.547	-75.2	1.436	-36.6	0.161	-13.2	0.090	-132.6
11000	0.559	-65.3	1.371	-44.2	0.164	-18.6	0.122	-114.0
11500	0.574	-55.7	1.310	-52.0	0.167	-24.2	0.162	-106.3
12000	0.608	-45.4	1.242	-60.7	0.165	-31.6	0.206	-99.1
12500	0.645	-36.2	1.159	-68.6	0.160	-37.3	0.232	-93.2
13000	0.677	-29.8	1.076	-76.3	0.156	-42.6	0.252	-85.4
13500	0.710	-26.1	1.001	-82.9	0.154	-47.7	0.258	-76.6
14000	0.729	-24.4	0.939	-89.7	0.151	-52.4	0.266	-64.8
14500	0.734	-23.0	0.889	-95.8	0.152	-57.7	0.284	-52.0
15000	0.735	-21.6	0.828	-102.4	0.156	-63.5	0.310	-45.1

## NSVF4009SG4

### S Parameters (Common emitter)

$V_{CE}=3V, I_C=10mA$

Freq(MHz)	S11	∠S11	S21	∠S21	S12	∠S12	S22	∠S22
500	0.702	-56.3	17.369	134.5	0.030	64.1	0.751	-37.2
1000	0.548	-95.2	11.870	109.5	0.047	51.6	0.521	-56.1
1500	0.460	-120.2	8.647	94.5	0.056	47.3	0.386	-65.7
2000	0.417	-137.4	6.729	84.0	0.064	45.7	0.308	-71.4
2500	0.384	-152.5	5.523	75.6	0.072	44.9	0.263	-75.7
3000	0.371	-164.2	4.678	67.6	0.080	43.7	0.234	-77.6
3500	0.364	-173.8	4.075	60.6	0.088	42.4	0.212	-78.7
4000	0.360	178.4	3.626	53.9	0.096	40.8	0.199	-78.7
4500	0.356	171.7	3.298	47.5	0.105	38.7	0.188	-78.3
5000	0.347	165.1	3.031	41.0	0.113	35.8	0.179	-78.7
5500	0.335	158.3	2.799	34.7	0.122	33.1	0.177	-80.7
6000	0.317	147.9	2.664	27.8	0.131	29.5	0.161	-84.8
6500	0.310	135.5	2.518	20.6	0.140	25.5	0.150	-93.0
7000	0.320	120.9	2.381	13.2	0.147	21.1	0.136	-104.2
7500	0.348	107.1	2.239	5.8	0.152	16.0	0.124	-117.2
8000	0.383	96.4	2.101	-1.4	0.157	11.5	0.103	-129.8
8500	0.428	89.7	1.978	-8.3	0.162	7.0	0.083	-145.3
9000	0.464	84.7	1.859	-15.0	0.164	2.9	0.057	-166.6
9500	0.493	81.3	1.769	-21.2	0.169	-1.5	0.041	153.8
10000	0.517	77.1	1.691	-28.0	0.173	-6.9	0.057	106.2
10500	0.533	72.1	1.616	-35.0	0.173	-12.3	0.095	88.8
11000	0.549	62.7	1.546	-42.2	0.176	-17.9	0.132	83.0
11500	0.564	53.3	1.479	-49.9	0.176	-24.3	0.169	82.2
12000	0.602	43.2	1.405	-58.1	0.175	-31.1	0.211	80.5
12500	0.639	34.3	1.317	-65.8	0.171	-37.1	0.236	76.7
13000	0.672	28.2	1.226	-73.5	0.165	-42.7	0.257	69.9
13500	0.704	24.8	1.141	-80.0	0.163	-47.9	0.262	61.4
14000	0.725	23.3	1.078	-86.6	0.160	-52.4	0.275	49.6
14500	0.728	21.9	1.014	-92.8	0.161	-58.5	0.292	38.2
15000	0.729	20.5	0.966	-99.0	0.163	-63.4	0.315	30.9

# NSVF4009SG4

## S Parameters (Common emitter)

$V_{CE}=3V, I_C=20mA$

Freq(MHz)	S11	∠S11	S21	∠S21	S12	∠S12	S22	∠S22
500	0.562	-72.2	22.269	125.7	0.026	62.0	0.659	-43.9
1000	0.442	-113.0	13.651	102.2	0.039	56.1	0.421	-61.7
1500	0.389	-136.8	9.560	89.2	0.049	54.2	0.302	-69.8
2000	0.364	-152.5	7.334	79.9	0.059	52.9	0.237	-74.2
2500	0.347	-165.9	5.959	72.3	0.069	52.3	0.200	-77.4
3000	0.341	-176.1	5.031	65.2	0.078	50.2	0.178	-78.2
3500	0.340	175.8	4.372	58.6	0.089	48.3	0.162	-77.7
4000	0.339	169.1	3.886	52.3	0.098	46.2	0.153	-76.0
4500	0.335	163.4	3.524	46.1	0.108	43.5	0.145	-74.3
5000	0.328	157.5	3.238	39.9	0.117	40.2	0.140	-72.7
5500	0.316	150.9	3.007	33.7	0.127	36.6	0.137	-73.7
6000	0.302	140.8	2.833	27.1	0.137	32.4	0.126	-77.4
6500	0.298	128.4	2.670	20.0	0.145	27.8	0.116	-86.6
7000	0.313	114.4	2.520	12.8	0.153	23.1	0.102	-99.7
7500	0.346	101.7	2.367	5.7	0.159	18.1	0.088	-115.9
8000	0.382	91.9	2.218	-1.4	0.164	13.3	0.070	-132.1
8500	0.428	86.2	2.088	-8.0	0.168	8.5	0.051	-156.7
9000	0.462	81.8	1.964	-14.6	0.171	3.9	0.033	156.9
9500	0.492	79.1	1.867	-20.6	0.174	-0.6	0.043	102.7
10000	0.514	75.0	1.781	-27.3	0.178	-6.1	0.075	79.7
10500	0.532	70.2	1.705	-34.1	0.180	-11.2	0.115	72.5
11000	0.549	61.0	1.628	-41.2	0.181	-17.4	0.152	70.6
11500	0.566	51.8	1.559	-48.5	0.183	-23.7	0.184	72.3
12000	0.603	41.9	1.484	-56.7	0.180	-30.6	0.224	71.7
12500	0.644	33.2	1.390	-64.3	0.175	-36.3	0.248	68.6
13000	0.675	27.2	1.295	-71.8	0.169	-41.8	0.267	62.1
13500	0.707	23.9	1.210	-78.3	0.167	-47.1	0.275	53.7
14000	0.724	22.5	1.142	-84.7	0.165	-52.1	0.289	42.7
14500	0.729	21.2	1.074	-91.0	0.165	-57.2	0.306	31.7
15000	0.730	19.9	1.032	-96.8	0.167	-62.9	0.328	24.1

# NSVF4009SG4

## S Parameters (Common emitter)

$V_{CE}=3V$ ,  $I_C=30mA$

Freq(MHz)	S11	∠S11	S21	∠S21	S12	∠S12	S22	∠S22
500	0.490	-81.8	23.946	121.7	0.024	63.5	0.613	-46.5
1000	0.404	-123.0	14.101	99.2	0.036	57.8	0.381	-62.8
1500	0.368	-145.3	9.747	87.1	0.047	57.2	0.271	-69.8
2000	0.353	-159.9	7.456	78.4	0.057	56.8	0.213	-73.4
2500	0.342	-172.5	6.032	70.9	0.068	55.1	0.180	-75.7
3000	0.340	178.3	5.086	64.0	0.078	53.1	0.161	-76.2
3500	0.340	170.8	4.418	57.7	0.088	50.9	0.148	-75.1
4000	0.337	164.6	3.925	51.5	0.098	48.4	0.141	-73.4
4500	0.336	159.1	3.556	45.4	0.108	45.3	0.135	-70.8
5000	0.327	153.5	3.267	39.2	0.118	41.8	0.131	-69.6
5500	0.317	147.1	3.039	33.1	0.128	38.0	0.130	-70.0
6000	0.306	137.1	2.856	26.4	0.138	33.5	0.120	-73.8
6500	0.303	124.9	2.689	19.5	0.147	29.3	0.110	-83.6
7000	0.320	111.4	2.535	12.3	0.154	24.3	0.096	-96.2
7500	0.354	99.2	2.380	5.3	0.161	19.0	0.082	-113.2
8000	0.391	90.0	2.226	-1.7	0.165	14.2	0.062	-130.2
8500	0.435	84.6	2.096	-8.4	0.170	9.4	0.044	-158.2
9000	0.469	80.4	1.971	-14.8	0.172	4.3	0.029	146.9
9500	0.499	77.8	1.874	-20.7	0.177	0.4	0.044	92.7
10000	0.522	73.8	1.786	-27.5	0.180	-5.4	0.078	75.3
10500	0.537	69.3	1.709	-34.2	0.182	-10.4	0.120	69.4
11000	0.555	59.9	1.634	-41.3	0.184	-16.6	0.154	68.1
11500	0.573	50.9	1.564	-48.6	0.184	-22.9	0.187	69.9
12000	0.611	41.2	1.487	-56.7	0.182	-30.1	0.225	70.0
12500	0.649	32.4	1.394	-64.2	0.177	-36.0	0.248	67.0
13000	0.681	26.5	1.298	-71.6	0.172	-41.1	0.268	60.7
13500	0.711	23.4	1.210	-78.1	0.169	-46.4	0.278	52.2
14000	0.730	22.0	1.142	-84.6	0.166	-51.5	0.291	40.9
14500	0.735	20.6	1.074	-90.7	0.166	-56.6	0.309	30.6
15000	0.734	19.3	1.037	-96.5	0.169	-62.7	0.332	23.0

# NSVF4009SG4

## PACKAGE DIMENSIONS

unit : mm

### SC-82FL / MCPH4

CASE 419AR

ISSUE O

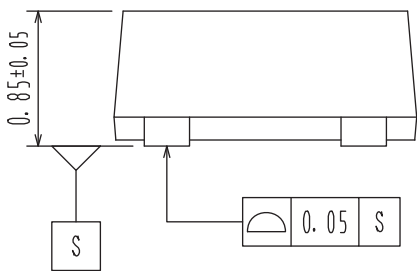
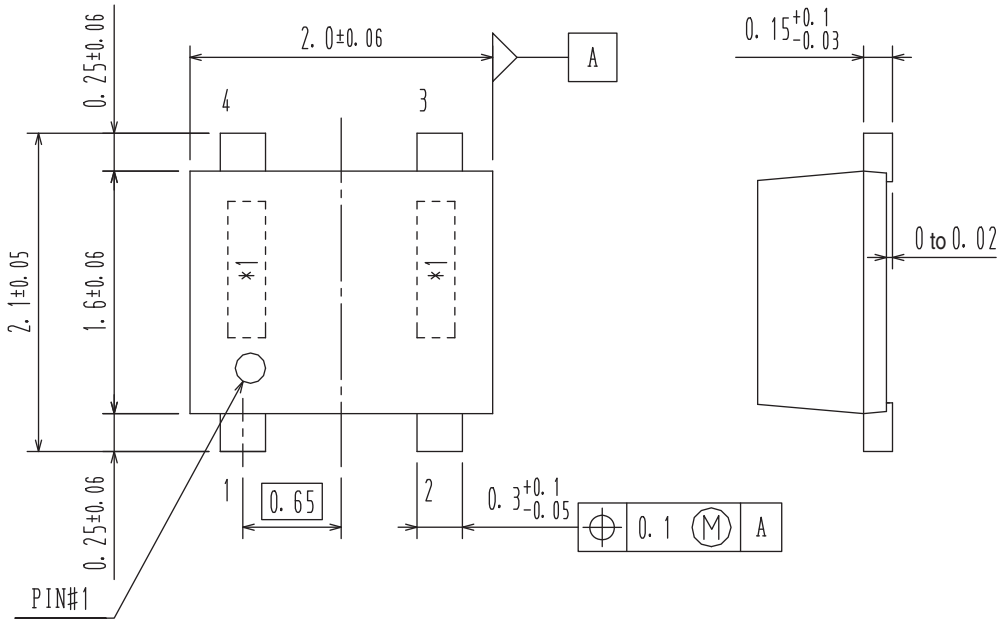

\*1 : Lot Indication

### RECOMMENDED SOLDERING FOOTPRINT

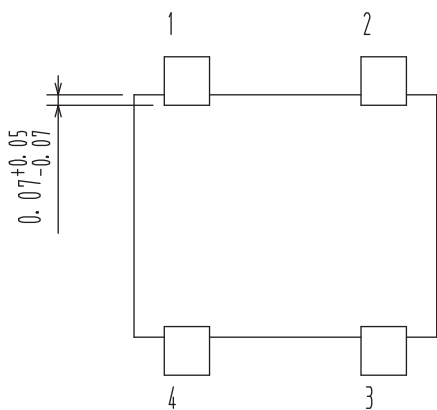
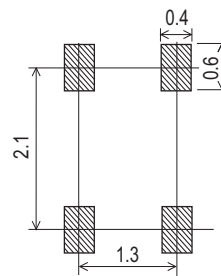

- 1 : Collector
- 2 : Emitter
- 3 : Base
- 4 : Emitter



# NSVF4009SG4

## ORDERING INFORMATION

Device	Marking	Package	Shipping (Qty / Packing)
NSVF4009SG4T1G	GG	SC-82FL / MCPH4 (Pb-Free / Halogen Free)	3,000 / Tape & Reel

† For information on tape and reel specifications, including part orientation and tape sizes, please refer to our Tape and Reel Packaging Specifications Brochure, BRD8011/D. [http://www.onsemi.com/pub\\_link/Collateral/BRD8011-D.PDF](http://www.onsemi.com/pub_link/Collateral/BRD8011-D.PDF)

ON Semiconductor and the ON Semiconductor logo are trademarks of Semiconductor Components Industries, LLC dba ON Semiconductor or its subsidiaries in the United States and/or other countries. ON Semiconductor owns the rights to a number of patents, trademarks, copyrights, trade secrets, and other intellectual property. A listing of ON Semiconductor's product/patent coverage may be accessed at [www.onsemi.com/site/pdf/Patent-Marketing.pdf](http://www.onsemi.com/site/pdf/Patent-Marketing.pdf). ON Semiconductor reserves the right to make changes without further notice to any products herein. ON Semiconductor makes no warranty, representation or guarantee regarding the suitability of its products for any particular purpose, nor does ON Semiconductor assume any liability arising out of the application or use of any product or circuit, and specifically disclaims any and all liability, including without limitation special, consequential or incidental damages. Buyer is responsible for its products and applications using ON Semiconductor products, including compliance with all laws, regulations and safety requirements or standards, regardless of any support or applications information provided by ON Semiconductor. "Typical" parameters which may be provided in ON Semiconductor data sheets and/or specifications can and do vary in different applications and actual performance may vary over time. All operating parameters, including "Typicals" must be validated for each customer application by customer's technical experts. ON Semiconductor does not convey any license under its patent rights nor the rights of others. ON Semiconductor products are not designed, intended, or authorized for use as a critical component in life support systems or any FDA Class 3 medical devices or medical devices with a same or similar classification in a foreign jurisdiction or any devices intended for implantation in the human body. Should Buyer purchase or use ON Semiconductor products for any such unintended or unauthorized application, Buyer shall indemnify and hold ON Semiconductor and its officers, employees, subsidiaries, affiliates, and distributors harmless against all claims, costs, damages, and expenses, and reasonable attorney fees arising out of, directly or indirectly, any claim of personal injury or death associated with such unintended or unauthorized use, even if such claim alleges that ON Semiconductor was negligent regarding the design or manufacture of the part. ON Semiconductor is an Equal Opportunity/Affirmative Action Employer. This literature is subject to all applicable copyright laws and is not for resale in any manner.