



Chipsmall Limited consists of a professional team with an average of over 10 year of expertise in the distribution of electronic components. Based in Hongkong, we have already established firm and mutual-benefit business relationships with customers from,Europe,America and south Asia,supplying obsolete and hard-to-find components to meet their specific needs.

With the principle of “Quality Parts,Customers Priority,Honest Operation,and Considerate Service”,our business mainly focus on the distribution of electronic components. Line cards we deal with include Microchip,ALPS,ROHM,Xilinx,Pulse,ON,Everlight and Freescale. Main products comprise IC,Modules,Potentiometer,IC Socket,Relay,Connector.Our parts cover such applications as commercial,industrial, and automotives areas.

We are looking forward to setting up business relationship with you and hope to provide you with the best service and solution. Let us make a better world for our industry!



Contact us

Tel: +86-755-8981 8866 Fax: +86-755-8427 6832

Email & Skype: info@chipsmall.com Web: www.chipsmall.com

Address: A1208, Overseas Decoration Building, #122 Zhenhua RD., Futian, Shenzhen, China



LOC	DIST	REVISIONS					
E	B	P	LTR	DESCRIPTION	DATE	DWN	APVD
			BA	NEW RELEASE	25-MAR-10	MRS	St.P

FOR FURTHER INFORMATION SEE DATA SHEET FOR
NTC SERIES-NEGATIVE TEMPERATURE COEFFICIENT CHIP THERMISTORS

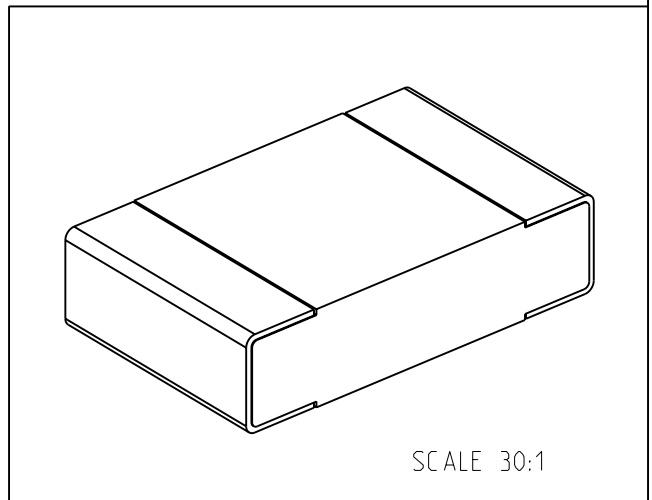
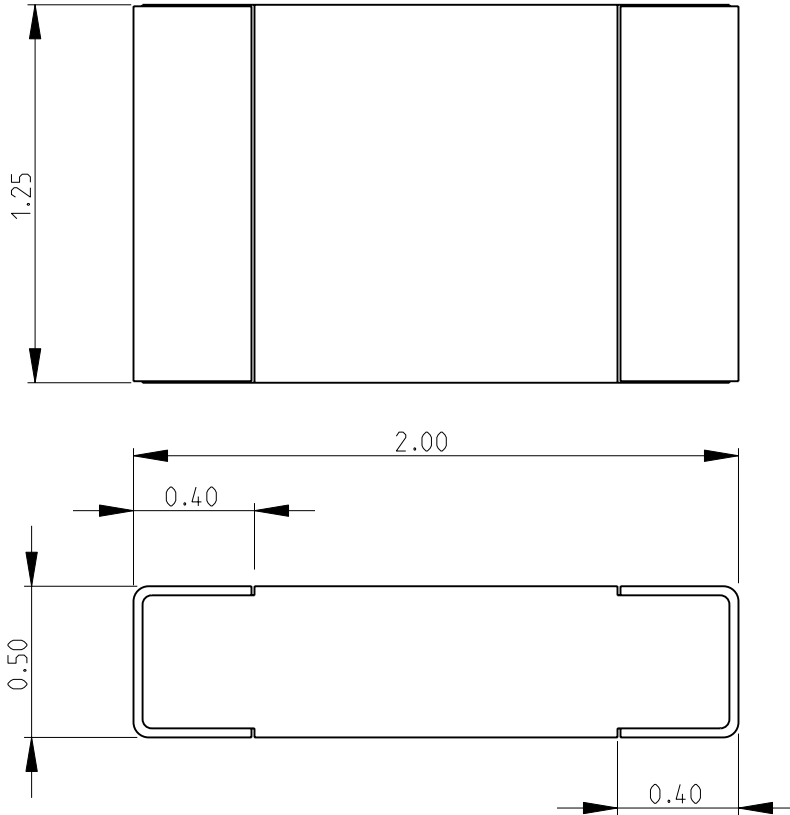

RoHS Compliant

SCALE 30:1

2010

RELEASED FOR PUBLICATION

THIS DRAWING IS UNPUBLISHED.

BY TYCO ELECTRONICS CORPORATION. ALL RIGHTS RESERVED.

DIMENSIONS: mm	DWN MAHARUDRA	25-MAR-10	MATERIAL	-	FINISH	-
	CHK ALLAN.P	25-MAR-10	Tyco Electronics Corporation Dorcan, Swindon, SN3 5HH			
TOLERANCES UNLESS OTHERWISE SPECIFIED:	APVD STEPHEN.P	25-MAR-10				
0 PLC ±0.2	PRODUCT SPEC	-	NAME NEGATIVE TEMPERATURE COEFFICIENT CHIP THERMISTORS SERIES NTC0805			
1 PLC ±0.1	APPLICATION SPEC	-	SIZE	CAGE CODE	DRAWING NO	RESTRICTED TO
2 PLC ±-			A 4	00779	© = 1624347	-
3 PLC ±-			CUSTOMER DRAWING			
4 PLC ±-	WEIGHT	-	SCALE	40:1	SHEET	1 OF 1
ANGLES ±5°			REV BA			