



Chipsmall Limited consists of a professional team with an average of over 10 year of expertise in the distribution of electronic components. Based in Hongkong, we have already established firm and mutual-benefit business relationships with customers from,Europe,America and south Asia,supplying obsolete and hard-to-find components to meet their specific needs.

With the principle of “Quality Parts,Customers Priority,Honest Operation,and Considerate Service”,our business mainly focus on the distribution of electronic components. Line cards we deal with include Microchip,ALPS,ROHM,Xilinx,Pulse,ON,Everlight and Freescale. Main products comprise IC,Modules,Potentiometer,IC Socket,Relay,Connector.Our parts cover such applications as commercial,industrial, and automotives areas.

We are looking forward to setting up business relationship with you and hope to provide you with the best service and solution. Let us make a better world for our industry!



## Contact us

Tel: +86-755-8981 8866 Fax: +86-755-8427 6832

Email & Skype: info@chipsmall.com Web: www.chipsmall.com

Address: A1208, Overseas Decoration Building, #122 Zhenhua RD., Futian, Shenzhen, China



# NUF4107FC

## Four Channel EMI Pi-Filter Array with Full USB Filter

This device is a four-channel EMI filter array for data lines. Greater than -35 dB attenuation is obtained at frequencies from 800 MHz to 2.2 GHz. It also offers USB filtering circuitry with speed detection. This includes the inline resistors for impedance matching and EMI filtering. ESD protection is provided across all capacitors.

### Features

- EMI Filtering and ESD Protection for Data Lines
- USB 1.1 Filtering Provided with Speed Detection
- Integration of 27 Discretes Offers Cost and Space Savings
- 350  $\mu\text{m}$  Solder Spheres
- All TVS Protected Inputs Comply with IEC61000-4-2 (Level 4)
  - 30 kV (Contact)
  - 30 kV (Air)
- Low Profile Flip-Chip Packaging
- MSL 1
- All Pins Exceed 2000 V Human Body Model (Note 1)
- Pb-Free Package is Available\*

### Typical Applications

- EMI and USB Filtering and ESD Protection for Data Lines
- Cell Phones
- Handheld Portables
- Notebook Computers
- MP3 Players

### MAXIMUM RATINGS ( $T_A = 25^\circ\text{C}$ )

Rating	Symbol	Value	Unit
ESD Discharge IEC61000-4-2 (Note 1)	$V_{PP}$	30	kV
- Air Discharge, Contact Discharge		16	
Human Body Model		0.4	
DC Power per Resistor	$P_R$	100	mW
DC Power per Package	$P_T$	600	mW
Junction Temperature	$T_J$	150	$^\circ\text{C}$
Operating Temperature Range	$T_{op}$	-40 to +85	$^\circ\text{C}$
Storage Temperature Range	$T_{stg}$	-55 to +150	$^\circ\text{C}$

Stresses exceeding Maximum Ratings may damage the device. Maximum Ratings are stress ratings only. Functional operation above the Recommended Operating Conditions is not implied. Extended exposure to stresses above the Recommended Operating Conditions may affect device reliability.

1. This does not include Pins B1, C1 and C2

\*For additional information on our Pb-Free strategy and soldering details, please download the ON Semiconductor Soldering and Mounting Techniques Reference Manual, SOLDERRM/D.



ON Semiconductor®

<http://onsemi.com>

### CIRCUIT DESCRIPTION

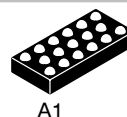
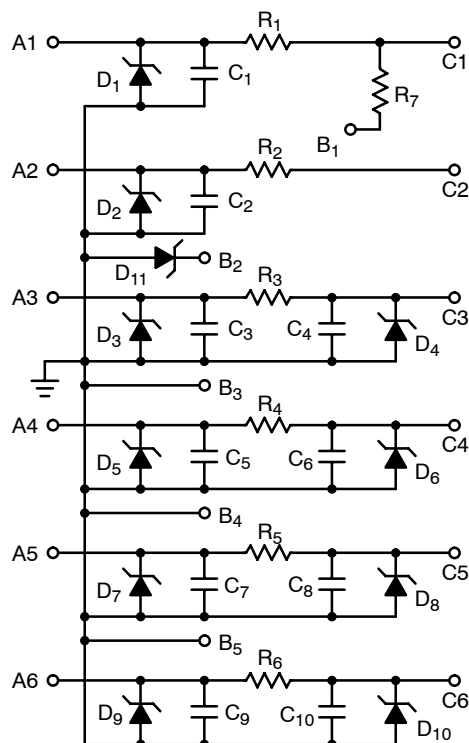

FLIP-CHIP-17  
CASE 499AD

### MARKING DIAGRAM

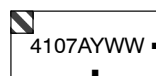

4107 = Device Code  
A = Assembly Location  
Y = Year  
WW = Work Week  
▪ = Pb-Free Package

(Note: Microdot may be in either location)

### ORDERING INFORMATION

Device	Package	Shipping†
NUF4107FCT1	Flip-Chip	3000 Tape & Reel
NUF4107FCT1G	Flip-Chip (Pb-Free)	3000 Tape & Reel

†For information on tape and reel specifications, including part orientation and tape sizes, please refer to our Tape and Reel Packaging Specifications Brochure, BRD8011/D.

# NUF4107FC

## ELECTRICAL CHARACTERISTICS ( $T_A = 25^\circ\text{C}$ unless otherwise noted)

Symbol	Characteristic	Min	Typ	Max	Unit
$V_{BR}$	$I_R = 1.0 \text{ mA}$	6.0	6.8	8.0	V
$I_R$	$V_{RM} = 3.3 \text{ V per line}$	-	-	0.1	$\mu\text{A}$
$R_3 - R_6$	EMI Filter Resistors	80	100	120	$\Omega$
$R_1, R_2$	USB Resistors; Impedance Matching	18	22	26	$\Omega$
$R_7$	USB Pull-up; Speed Detection Resistor	1250	1500	1750	$\Omega$
$C_{line}$	At 2.5 V Bias	48	60	72	pF
C1, C2	At Pins A1 and A2; At 2.5 V Bias	29	36	43	pF
$C_{power}$	At Pins B2; At 2.5 V Bias	54	68	82	pF

# NUF4107FC

## TYPICAL CHARACTERISTICS

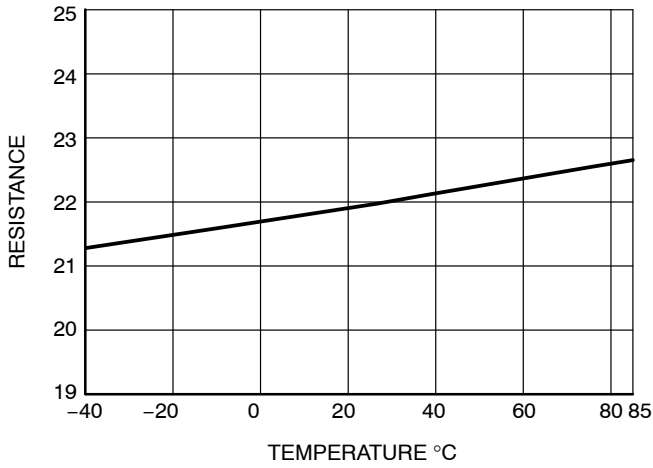

Figure 1. USB 1.1 Resistors (R1, R2) vs. Temperature

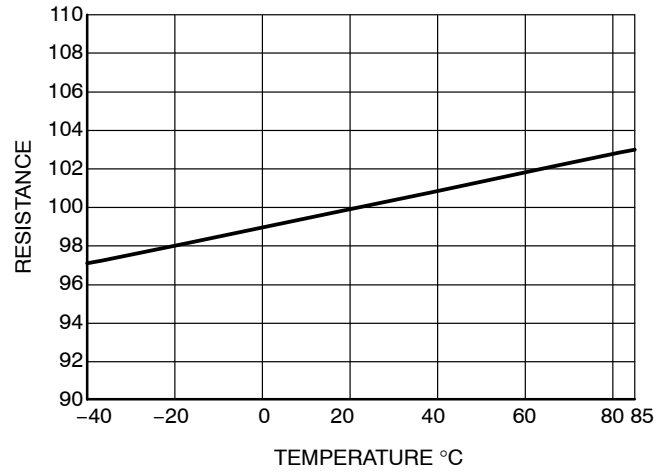

Figure 2. Data Resistors (R3, R4, R5, R6) vs. Temperature

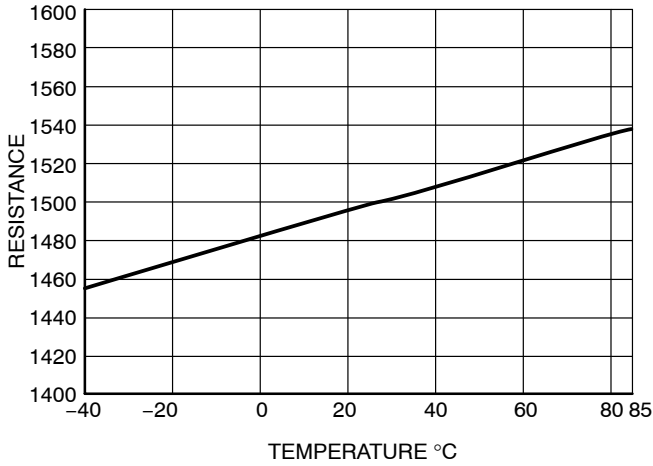

Figure 3. Pull-up Resistor (R7) vs. Temperature

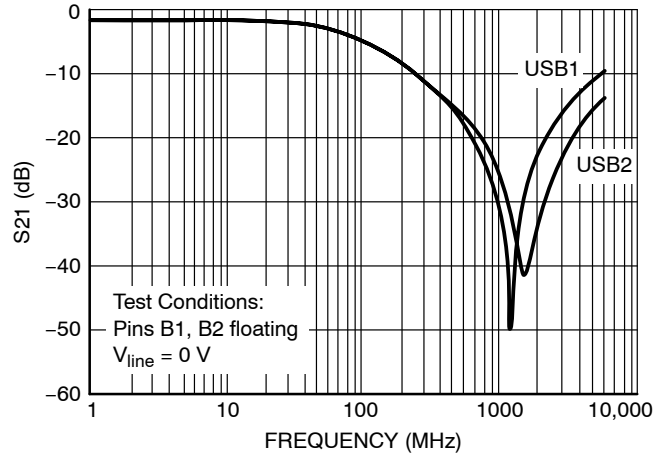

Figure 4. Insertion Loss Characteristic USB1, USB2

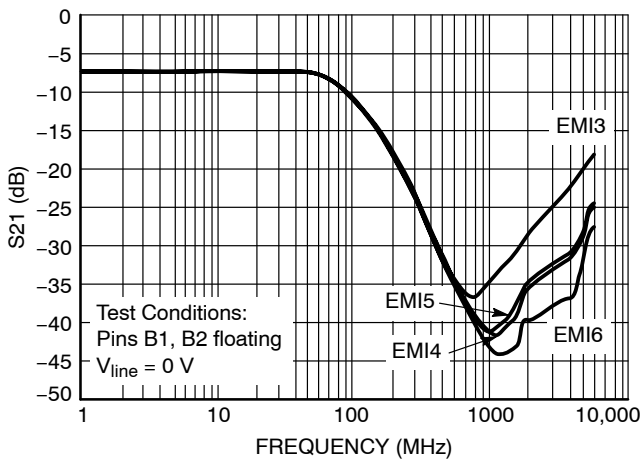

Figure 5. Insertion Loss Characteristic EMI3, EMI4, EMI5, EMI6

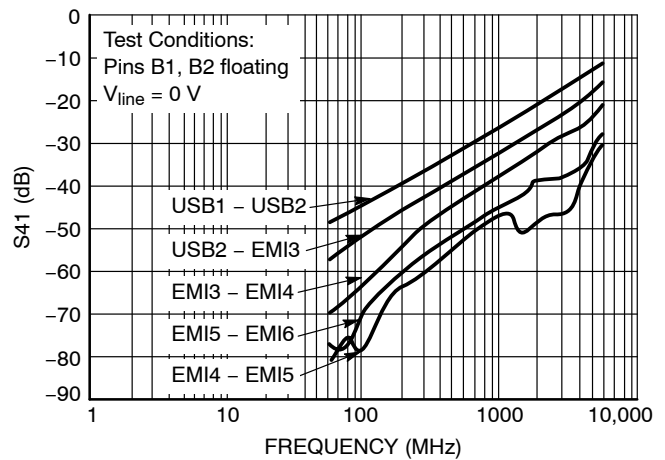

Figure 6. Analog Crosstalk Curve EMI Filter

# NUF4107FC

## Printed Circuit Board Recommendations

Parameter	500 $\mu\text{m}$ Pitch 300 $\mu\text{m}$ Solder Ball
PCB Pad Size	250 $\mu\text{m}$ +25 -0
Pad Shape	Round
Pad Type	NSMD
Solder Mask Opening	350 $\mu\text{m}$ $\pm$ 25
Solder Stencil Thickness	125 $\mu\text{m}$
Stencil Aperture	250 x 250 $\mu\text{m}$ sq.
Solder Flux Ratio	50/50
Solder Paste Type	No Clean Type 3 or Finer
Trace Finish	OSP Cu
Trace Width	150 $\mu\text{m}$ Max

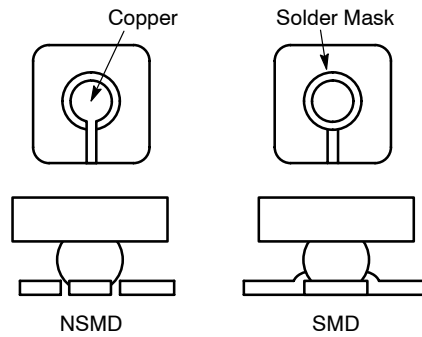

Figure 7. Solder Mask versus Non-Solder Mask Definition

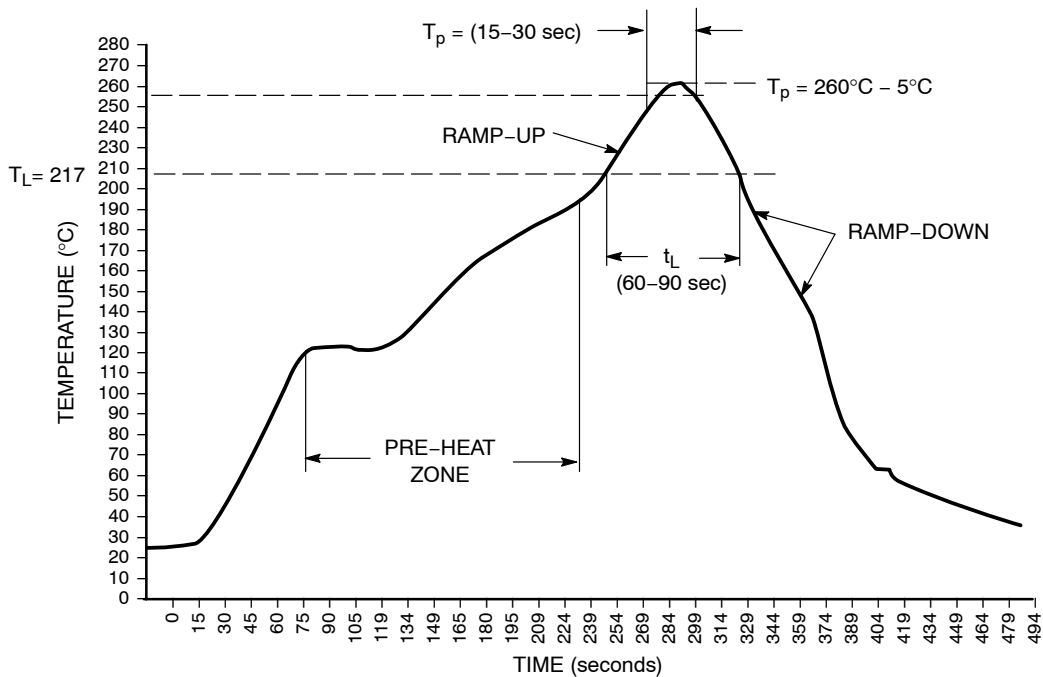
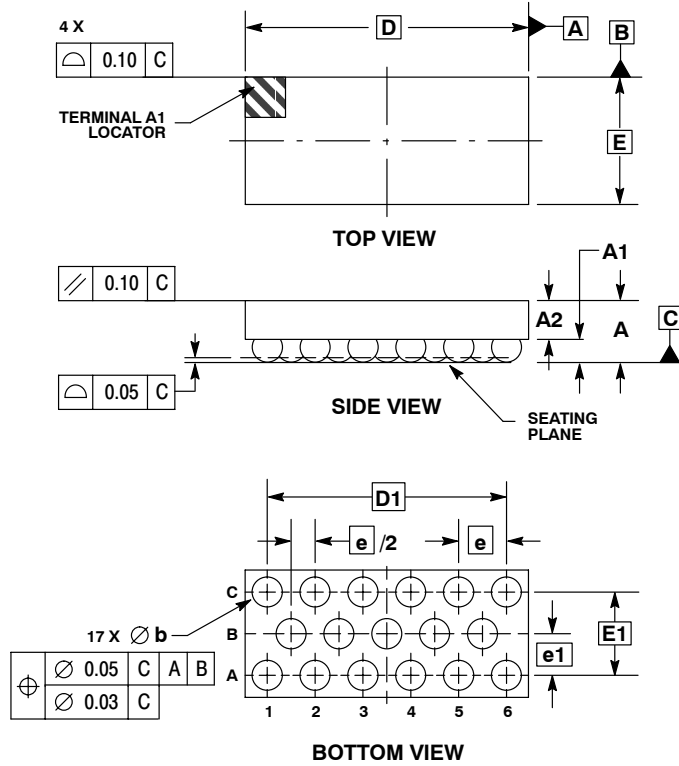

Figure 8. Typical Pb-Free Solder Heating Profile

# NUF4107FC

## PACKAGE DIMENSIONS

FLIP-CHIP-17 CSP  
CASE 499AD-01  
ISSUE A



**NOTES:**

1. DIMENSIONING AND TOLERANCING PER ASME Y14.5M, 1994.
2. CONTROLLING DIMENSION: MILLIMETER.
3. COPLANARITY APPLIES TO SPHERICAL CROWNS OF SOLDER BALLS.

DIM	MILLIMETERS	
	MIN	MAX
A	---	0.740
A1	0.250	0.310
A2	0.380	0.430
D	2.960 BSC	
E	1.330 BSC	
b	0.350	0.410
e	0.500 BSC	
e1	0.435 BSC	
D1	2.500 BSC	
E1	0.870 BSC	

ON Semiconductor and are registered trademarks of Semiconductor Components Industries, LLC (SCILLC). SCILLC reserves the right to make changes without further notice to any products herein. SCILLC makes no warranty, representation or guarantee regarding the suitability of its products for any particular purpose, nor does SCILLC assume any liability arising out of the application or use of any product or circuit, and specifically disclaims any and all liability, including without limitation special, consequential or incidental damages. "Typical" parameters which may be provided in SCILLC data sheets and/or specifications can and do vary in different applications and actual performance may vary over time. All operating parameters, including "Typicals" must be validated for each customer application by customer's technical experts. SCILLC does not convey any license under its patent rights nor the rights of others. SCILLC products are not designed, intended, or authorized for use as components in systems intended for surgical implant into the body, or other applications intended to support or sustain life, or for any other application in which the failure of the SCILLC product could create a situation where personal injury or death may occur. Should Buyer purchase or use SCILLC products for any such unintended or unauthorized application, Buyer shall indemnify and hold SCILLC and its officers, employees, subsidiaries, affiliates, and distributors harmless against all claims, costs, damages, and expenses, and reasonable attorney fees arising out of, directly or indirectly, any claim of personal injury or death associated with such unintended or unauthorized use, even if such claim alleges that SCILLC was negligent regarding the design or manufacture of the part. SCILLC is an Equal Opportunity/Affirmative Action Employer. This literature is subject to all applicable copyright laws and is not for resale in any manner.

### PUBLICATION ORDERING INFORMATION

**LITERATURE FULFILLMENT:**  
Literature Distribution Center for ON Semiconductor  
P.O. Box 611312, Phoenix, Arizona 85082-1312 USA  
**Phone:** 480-829-7710 or 800-344-3860 Toll Free USA/Canada  
**Fax:** 480-829-7709 or 800-344-3867 Toll Free USA/Canada  
**Email:** orderlit@onsemi.com

**N. American Technical Support:** 800-282-9855 Toll Free  
USA/Canada

**Japan:** ON Semiconductor, Japan Customer Focus Center  
2-9-1 Kamimeguro, Meguro-ku, Tokyo, Japan 153-0051  
**Phone:** 81-3-5773-3850

**ON Semiconductor Website:** <http://onsemi.com>

**Order Literature:** <http://www.onsemi.com/litorder>

For additional information, please contact your local Sales Representative.