



Chipsmall Limited consists of a professional team with an average of over 10 year of expertise in the distribution of electronic components. Based in Hongkong, we have already established firm and mutual-benefit business relationships with customers from,Europe,America and south Asia,supplying obsolete and hard-to-find components to meet their specific needs.

With the principle of "Quality Parts,Customers Priority,Honest Operation,and Considerate Service",our business mainly focus on the distribution of electronic components. Line cards we deal with include Microchip,ALPS,ROHM,Xilinx,Pulse,ON,Everlight and Freescale. Main products comprise IC,Modules,Potentiometer,IC Socket,Relay,Connector.Our parts cover such applications as commercial,industrial, and automotives areas.

We are looking forward to setting up business relationship with you and hope to provide you with the best service and solution. Let us make a better world for our industry!



Contact us

Tel: +86-755-8981 8866 Fax: +86-755-8427 6832

Email & Skype: info@chipsmall.com Web: www.chipsmall.com

Address: A1208, Overseas Decoration Building, #122 Zhenhua RD., Futian, Shenzhen, China



NTR4501N, NVR4501N

Power MOSFET

20 V, 3.2 A, Single N-Channel, SOT-23



ON Semiconductor®

www.onsemi.com

Features

- Leading Planar Technology for Low Gate Charge / Fast Switching
- 2.5 V Rated for Low Voltage Gate Drive
- SOT-23 Surface Mount for Small Footprint
- NVR Prefix for Automotive and Other Applications Requiring Unique Site and Control Change Requirements; AEC-Q101 Qualified and PPAP Capable
- These Devices are Pb-Free and are RoHS Compliant

Applications

- Load/Power Switch for Portables
- Load/Power Switch for Computing
- DC-DC Conversion

MAXIMUM RATINGS (T_J = 25°C unless otherwise stated)

Parameter		Symbol	Value	Unit	
Drain-to-Source Voltage		V _{DS}	20	V	
Gate-to-Source Voltage		V _{GS}	±12	V	
Continuous Drain Current (Note 1)	Steady State	I _D	T _A = 25°C	3.2	A
			T _A = 85°C	2.4	A
Steady State Power Dissipation (Note 1)	Steady State	P _D	1.25	W	
Pulsed Drain Current	t _p = 10 μs	I _{DM}	10.0	A	
Operating Junction and Storage Temperature		T _J , T _{stg}	-55 to 150	°C	
Continuous Source Current (Body Diode)		I _S	1.6	A	
Lead Temperature for Soldering Purposes (1/8" from case for 10 s)		T _L	260	°C	

THERMAL RESISTANCE RATINGS

Parameter	Symbol	Max	Unit
Junction-to-Ambient (Note 1)	R _{θJA}	100	°C/W
Junction-to-Ambient (Note 2)	R _{θJA}	300	

Stresses exceeding those listed in the Maximum Ratings table may damage the device. If any of these limits are exceeded, device functionality should not be assumed, damage may occur and reliability may be affected.

1. Surface-mounted on FR4 board using 1 in sq pad size (Cu area = 1.127 in sq [1 oz] including traces).
2. Surface-mounted on FR4 board using the minimum recommended pad size.

V _{(BR)DSS}	R _{DS(on) Typ}	I _{D Max} (Note 1)
20 V	70 mΩ @ 4.5 V	3.6 A
	88 mΩ @ 2.5 V	3.1 A

N-Channel

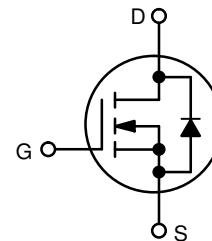

MARKING DIAGRAM & PIN ASSIGNMENT

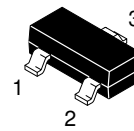

**SOT-23
CASE 318
STYLE 21**

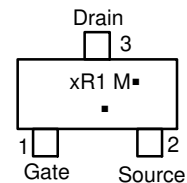

TR1 = Device Code for NTR4501N
 VR1 = Device Code for NVR4501N
 M = Date Code*
 ■ = Pb-Free Package

(Note: Microdot may be in either location)

*Date Code orientation and/or overbar may vary depending upon manufacturing location.

ORDERING INFORMATION

Device	Package	Shipping†
NTR4501NT1G	SOT-23 (Pb-Free)	3000 / Tape & Reel
NVR4501NT1G	SOT-23 (Pb-Free)	3000 / Tape & Reel

†For information on tape and reel specifications, including part orientation and tape sizes, please refer to our Tape and Reel Packaging Specifications Brochure, BRD8011/D.

NTR4501N, NVR4501N

Electrical Characteristics (T_J = 25°C unless otherwise specified)

Parameter	Symbol	Test Condition	Min	Typ	Max	Units
OFF CHARACTERISTICS						
Drain-to-Source Breakdown Voltage (Note 3)	V _{(BR)DSS}	V _{GS} = 0 V, I _D = 250 μA	20	24.5		V
Drain-to-Source Breakdown Voltage Temperature Coefficient	V _{(BR)DSS} /T _J			22		mV/°C
Zero Gate Voltage Drain Current	I _{DSS}	V _{GS} = 0 V, T _J = 25°C			1.5	μA
		V _{DS} = 16 V, T _J = 85°C			10	μA
Gate-to-Source Leakage Current	I _{GSS}	V _{DS} = 0 V, V _{GS} = ±12 V			±100	nA

ON CHARACTERISTICS

Gate Threshold Voltage (Note 3)	V _{GS(TH)}	V _{GS} = V _{DS} , I _D = 250 μA	0.65		1.2	V
Negative Threshold Temperature Coefficient	V _{GS(TH)} /T _J			-2.3		mV/°C
Drain-to-Source On Resistance	R _{DS(on)}	V _{GS} = 4.5 V, I _D = 3.6 A		70	80	mΩ
		V _{GS} = 2.5 V, I _D = 3.1 A		88	105	
Forward Transconductance	g _{FS}	V _{DS} = 5.0 V, I _D = 3.6 A		9		S

CHARGES AND CAPACITANCES

Input Capacitance	C _{iss}	V _{GS} = 0 V, f = 1.0 MHz, V _{DS} = 10 V		200		pF
Output Capacitance	C _{oss}			80		
Reverse Transfer Capacitance	C _{rss}			50		
Total Gate Charge	Q _{G(TOT)}	V _{GS} = 4.5 V, V _{DS} = 10 V, I _D = 3.6 A		2.4	6.0	nC
Gate-to-Source Gate Charge	Q _{GS}			0.5		
Gate-to-Drain Charge	Q _{GD}			0.6		

SWITCHING CHARACTERISTICS (Note 4)

Turn-On Delay Time	t _{d(on)}	V _{GS} = 4.5 V, V _{DS} = 10 V, I _D = 3.6 A, R _G = 6.0 Ω		6.5	13	ns
Rise Time	t _r			12	24	
Turn-Off Delay Time	t _{d(off)}			12	24	
Fall Time	t _f			3	6	

SOURCE-DRAIN DIODE CHARACTERISTICS

Forward Diode Voltage	V _{SD}	V _{GS} = 0 V, I _{SD} = 1.6 A		0.8	1.2	V
Reverse Recovery Time	t _{RR}	V _{GS} = 0 V, dI _S /dt = 100 A/μs, I _S = 1.6 A		7.1		ns
Charge Time	t _a			5		
Discharge Time	t _b			1.9		
Reverse Recovery Charge	Q _{RR}			3.0		

3. Pulse Test: Pulse width ≤ 300 μs, duty cycle ≤ 2%.

4. Switching characteristics are independent of operating junction temperatures.

NTR4501N, NVR4501N

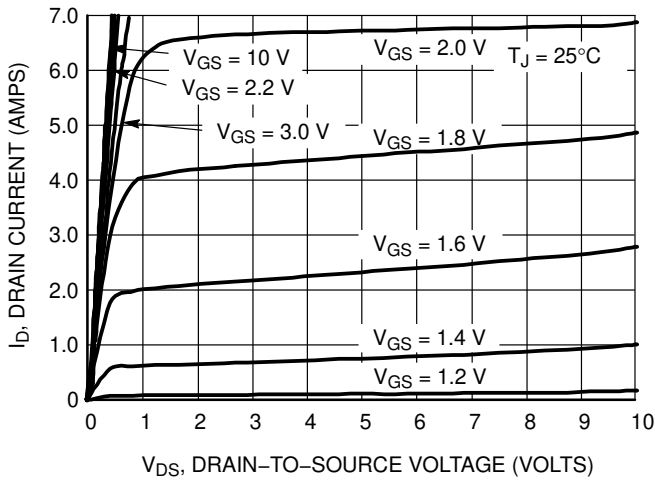

Figure 1. On-Region Characteristics

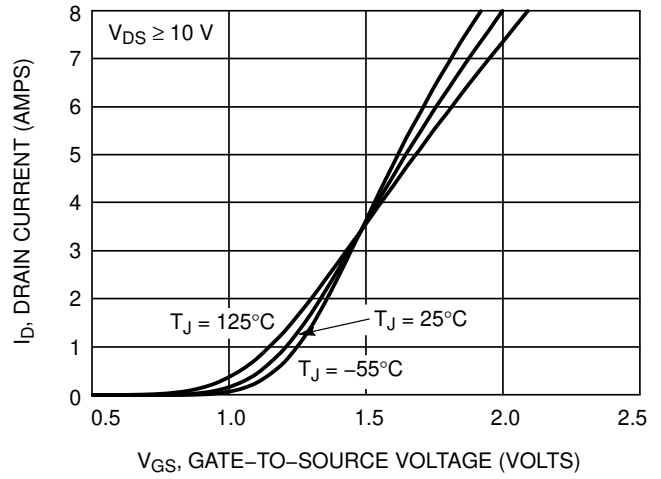

Figure 2. Transfer Characteristics

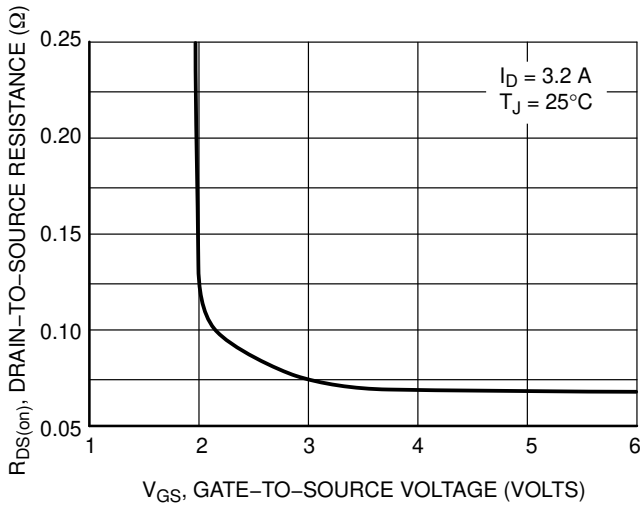

Figure 3. On-Resistance versus Gate-to-Source Voltage

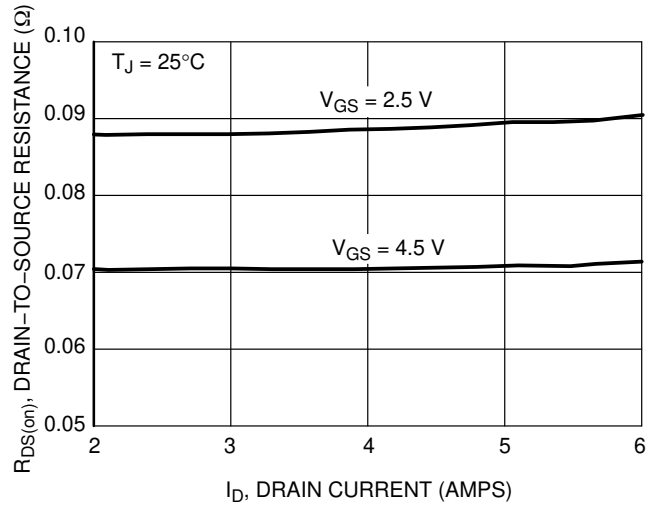

Figure 4. On-Resistance versus Drain Current and Gate Voltage

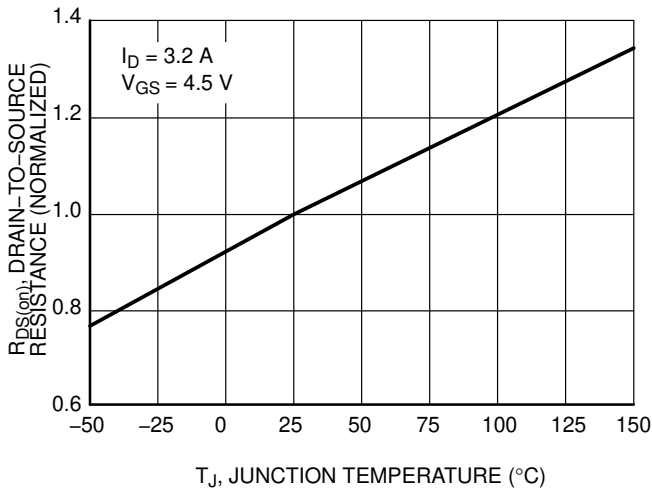

Figure 5. On-Resistance Variation with Temperature

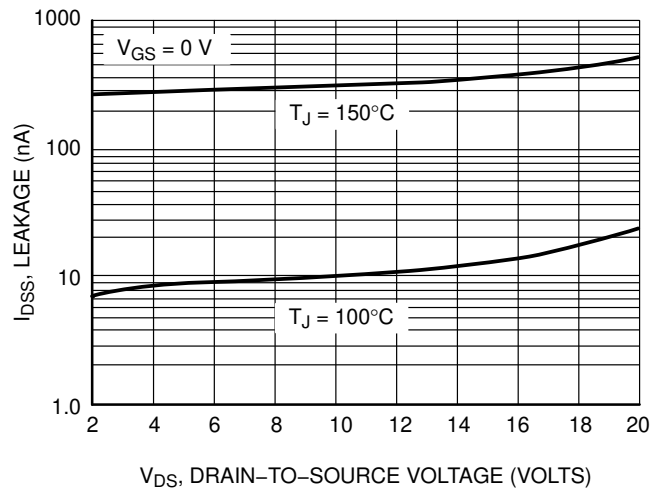

Figure 6. Drain-to-Source Leakage Current versus Voltage

NTR4501N, NVR4501N

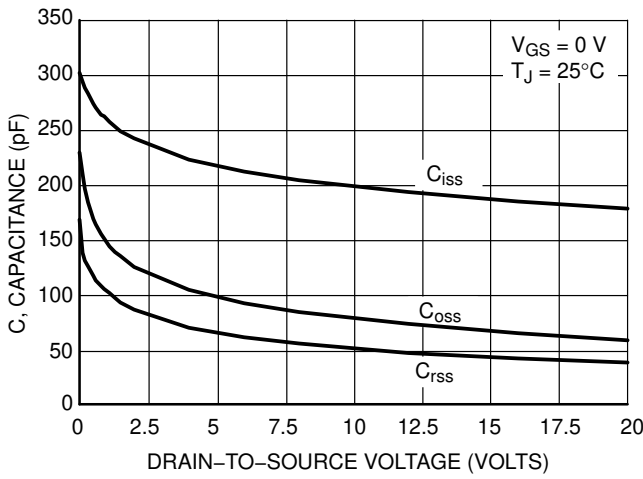

Figure 7. Capacitance Variation

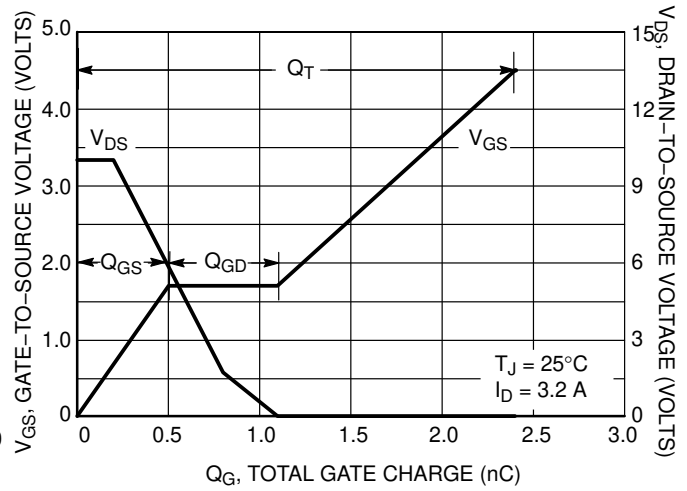

Figure 8. Gate-to-Source and Drain-to-Source Voltage versus Total Charge

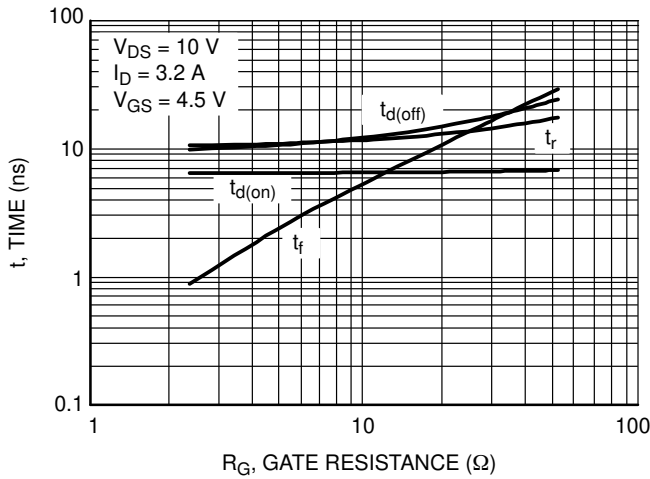

Figure 9. Resistive Switching Time Variation versus Gate Resistance

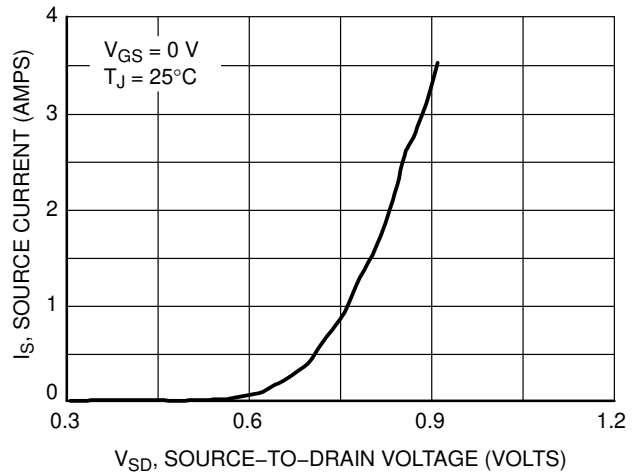

Figure 10. Diode Forward Voltage versus Current

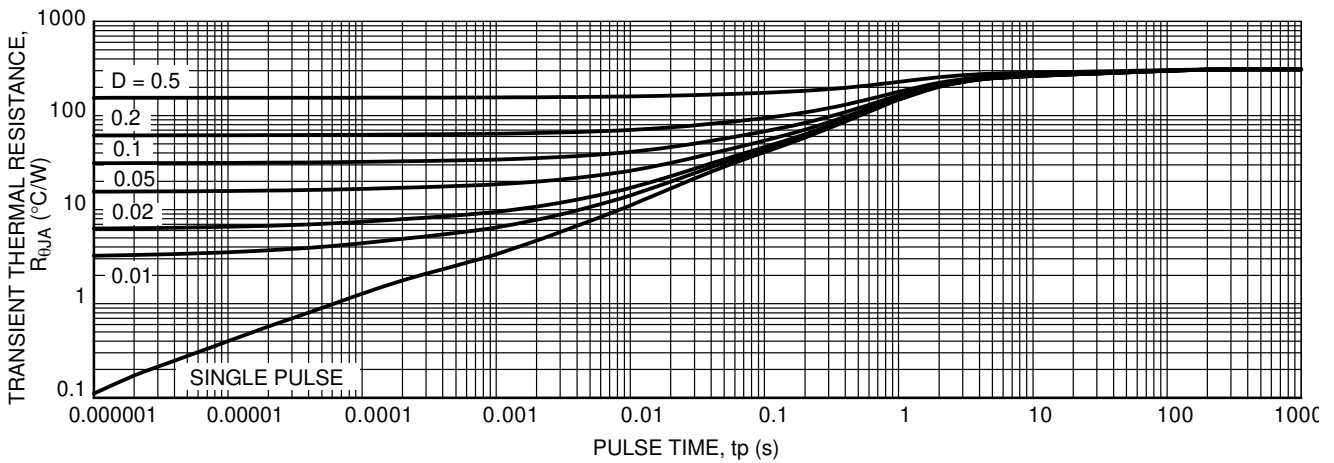
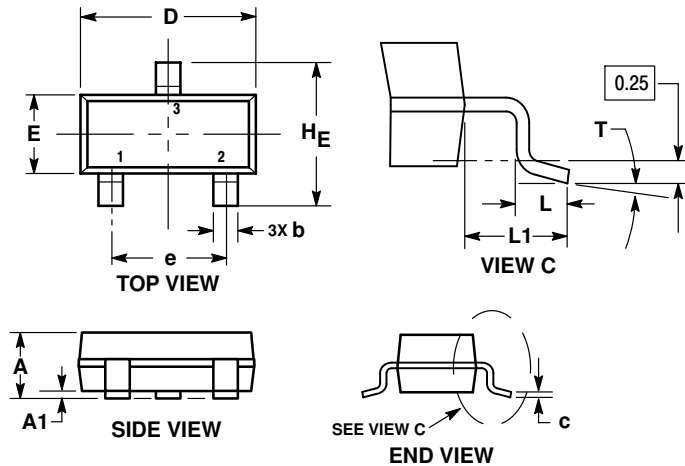

Figure 11. Thermal Response

NTR4501N, NVR4501N

PACKAGE DIMENSIONS

SOT-23 (TO-236)
CASE 318-08
ISSUE AR



NOTES:

1. DIMENSIONING AND TOLERANCING PER ASME Y14.5M, 1994.
2. CONTROLLING DIMENSION: MILLIMETERS.
3. MAXIMUM LEAD THICKNESS INCLUDES LEAD FINISH. MINIMUM LEAD THICKNESS IS THE MINIMUM THICKNESS OF THE BASE MATERIAL.
4. DIMENSIONS D AND E DO NOT INCLUDE MOLD FLASH, PROTRUSIONS, OR GATE BURRS.

DIM	MILLIMETERS			INCHES		
	MIN	NOM	MAX	MIN	NOM	MAX
A	0.89	1.00	1.11	0.035	0.039	0.044
A1	0.01	0.06	0.10	0.000	0.002	0.004
b	0.37	0.44	0.50	0.015	0.017	0.020
c	0.08	0.14	0.20	0.003	0.006	0.008
D	2.80	2.90	3.04	0.110	0.114	0.120
E	1.20	1.30	1.40	0.047	0.051	0.055
e	1.78	1.90	2.04	0.070	0.075	0.080
L	0.30	0.43	0.55	0.012	0.017	0.022
L1	0.35	0.54	0.69	0.014	0.021	0.027
HE	2.10	2.40	2.64	0.083	0.094	0.104
T	0°	---	10°	0°	---	10°

STYLE 21:

1. GATE
2. SOURCE
3. DRAIN

RECOMMENDED SOLDERING FOOTPRINT

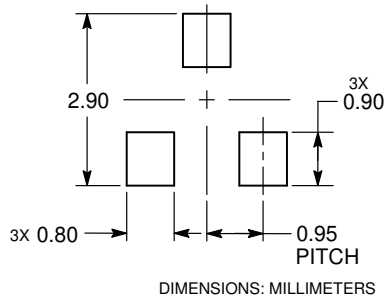

ON Semiconductor and are trademarks of Semiconductor Components Industries, LLC dba ON Semiconductor or its subsidiaries in the United States and/or other countries. ON Semiconductor owns the rights to a number of patents, trademarks, copyrights, trade secrets, and other intellectual property. A listing of ON Semiconductor's product/patent coverage may be accessed at www.onsemi.com/site/pdf/Patent-Marking.pdf. ON Semiconductor reserves the right to make changes without further notice to any products herein. ON Semiconductor makes no warranty, representation or guarantee regarding the suitability of its products for any particular purpose, nor does ON Semiconductor assume any liability arising out of the application or use of any product or circuit, and specifically disclaims any and all liability, including without limitation special, consequential or incidental damages. Buyer is responsible for its products and applications using ON Semiconductor products, including compliance with all laws, regulations and safety requirements or standards, regardless of any support or applications information provided by ON Semiconductor. "Typical" parameters which may be provided in ON Semiconductor data sheets and/or specifications can and do vary in different applications and actual performance may vary over time. All operating parameters, including "Typicals" must be validated for each customer application by customer's technical experts. ON Semiconductor does not convey any license under its patent rights nor the rights of others. ON Semiconductor products are not designed, intended, or authorized for use as a critical component in life support systems or any FDA Class 3 medical devices or medical devices with a same or similar classification in a foreign jurisdiction or any devices intended for implantation in the human body. Should Buyer purchase or use ON Semiconductor products for any such unintended or unauthorized application, Buyer shall indemnify and hold ON Semiconductor and its officers, employees, subsidiaries, affiliates, and distributors harmless against all claims, costs, damages, and expenses, and reasonable attorney fees arising out of, directly or indirectly, any claim of personal injury or death associated with such unintended or unauthorized use, even if such claim alleges that ON Semiconductor was negligent regarding the design or manufacture of the part. ON Semiconductor is an Equal Opportunity/Affirmative Action Employer. This literature is subject to all applicable copyright laws and is not for resale in any manner.

PUBLICATION ORDERING INFORMATION

LITERATURE FULFILLMENT:

Literature Distribution Center for ON Semiconductor
19521 E. 32nd Pkwy, Aurora, Colorado 80011 USA
Phone: 303-675-2175 or 800-344-3860 Toll Free USA/Canada
Fax: 303-675-2176 or 800-344-3867 Toll Free USA/Canada
Email: orderlit@onsemi.com

N. American Technical Support: 800-282-9855 Toll Free
USA/Canada
Europe, Middle East and Africa Technical Support:
Phone: 421 33 790 2910
Japan Customer Focus Center
Phone: 81-3-5817-1050

ON Semiconductor Website: www.onsemi.com

Order Literature: <http://www.onsemi.com/orderlit>

For additional information, please contact your local Sales Representative