



Chipsmall Limited consists of a professional team with an average of over 10 year of expertise in the distribution of electronic components. Based in Hongkong, we have already established firm and mutual-benefit business relationships with customers from,Europe,America and south Asia,supplying obsolete and hard-to-find components to meet their specific needs.

With the principle of “Quality Parts,Customers Priority,Honest Operation,and Considerate Service”,our business mainly focus on the distribution of electronic components. Line cards we deal with include Microchip,ALPS,ROHM,Xilinx,Pulse,ON,Everlight and Freescale. Main products comprise IC,Modules,Potentiometer,IC Socket,Relay,Connector.Our parts cover such applications as commercial,industrial, and automotives areas.

We are looking forward to setting up business relationship with you and hope to provide you with the best service and solution. Let us make a better world for our industry!



Contact us

Tel: +86-755-8981 8866 Fax: +86-755-8427 6832

Email & Skype: info@chipsmall.com Web: www.chipsmall.com

Address: A1208, Overseas Decoration Building, #122 Zhenhua RD., Futian, Shenzhen, China



NTJD4001N, NVTJD4001N

Small Signal MOSFET

30 V, 250 mA, Dual N-Channel, SC-88

Features

- Low Gate Charge for Fast Switching
- Small Footprint – 30% Smaller than TSOP-6
- ESD Protected Gate
- AEC Q101 Qualified – NVTJD4001N
- These Devices are Pb-Free and are RoHS Compliant

Applications

- Low Side Load Switch
- Li-Ion Battery Supplied Devices – Cell Phones, PDAs, DSC
- Buck Converters
- Level Shifts

MAXIMUM RATINGS (T_J = 25°C unless otherwise stated)

Parameter		Symbol	Value	Units	
Drain-to-Source Voltage		V _{DSS}	30	V	
Gate-to-Source Voltage		V _{GS}	±20	V	
Continuous Drain Current (Note 1)	Steady State	I _D	T _A = 25 °C	250	mA
			T _A = 85 °C	180	
Power Dissipation (Note 1)	Steady State	P _D	T _A = 25 °C	272	mW
Pulsed Drain Current		t = 10 μs	I _{DM}	600	mA
Operating Junction and Storage Temperature		T _J , T _{STG}	-55 to 150	°C	
Source Current (Body Diode)		I _S	250	mA	
Lead Temperature for Soldering Purposes (1/8" from case for 10 s)		T _L	260	°C	

THERMAL RESISTANCE RATINGS (Note 1)

Parameter	Symbol	Value	Unit
Junction-to-Ambient – Steady State	R _{θJA}	458	°C/W
Junction-to-Lead – Steady State	R _{θJL}	252	

Stresses exceeding those listed in the Maximum Ratings table may damage the device. If any of these limits are exceeded, device functionality should not be assumed, damage may occur and reliability may be affected.

1. Surface mounted on FR4 board using min pad size (Cu area = 0.155 in sq [1 oz] including traces).



ON Semiconductor®

www.onsemi.com

V _{(BR)DSS}	R _{DS(on)} TYP	I _D Max
30 V	1.0 Ω @ 4.0 V	250 mA
	1.5 Ω @ 2.5 V	

SOT-363
SC-88 (6 LEADS)

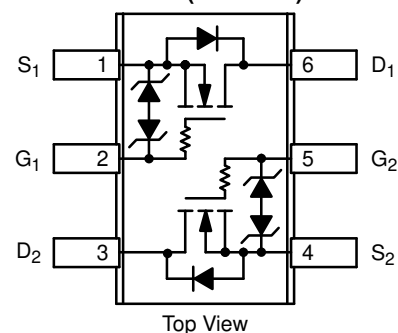

Top View

MARKING DIAGRAM & PIN ASSIGNMENT

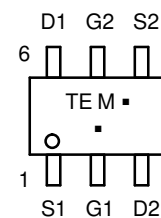

TE = Device Code
M = Date Code
▪ = Pb-Free Package

(Note: Microdot may be in either location)

ORDERING INFORMATION

Device	Package	Shipping†
NTJD4001NT1G	SOT-363 (Pb-Free)	3000 / Tape & Reel
NVTJD4001NT1G	SOT-363 (Pb-Free)	3000 / Tape & Reel

†For information on tape and reel specifications, including part orientation and tape sizes, please refer to our Tape and Reel Packaging Specification Brochure, BRD8011/D.

NTJD4001N, NVTJD4001N

ELECTRICAL CHARACTERISTICS (T_J = 25°C unless otherwise stated)

Parameter	Symbol	Test Condition	Min	Typ	Max	Unit
-----------	--------	----------------	-----	-----	-----	------

OFF CHARACTERISTICS

Drain-to-Source Breakdown Voltage	V _{(BR)DSS}	V _{GS} = 0 V, I _D = 100 μA	30			V
Drain-to-Source Breakdown Voltage Temperature Coefficient	V _{(BR)DSS} /T _J			56		mV/°C
Zero Gate Voltage Drain Current	I _{DSS}	V _{GS} = 0 V, V _{DS} = 30 V			1.0	μA
Gate-to-Source Leakage Current	I _{GSS}	V _{DS} = 0 V, V _{GS} = ±10 V			±1.0	μA

ON CHARACTERISTICS (Note 2)

Gate Threshold Voltage	V _{GS(TH)}	V _{GS} = V _{DS} , I _D = 100 μA	0.8	1.2	1.5	V
Gate Threshold Temperature Coefficient	V _{GS(TH)} /T _J			-3.2		mV/°C
Drain-to-Source On Resistance	R _{DS(on)}	V _{GS} = 4.0 V, I _D = 10 mA		1.0	1.5	Ω
		V _{GS} = 2.5 V, I _D = 10 mA		1.5	2.5	
Forward Transconductance	g _{FS}	V _{DS} = 3.0 V, I _D = 10 mA		80		mS

CHARGES AND CAPACITANCES

Input Capacitance	C _{ISS}	V _{GS} = 0 V, f = 1.0 MHz, V _{DS} = 5.0 V		20	33	pF
Output Capacitance	C _{OSS}			19	32	
Reverse Transfer Capacitance	C _{RSS}			7.25	12	
Total Gate Charge	Q _{G(TOT)}	V _{GS} = 5.0 V, V _{DS} = 24 V, I _D = 0.1 A		0.9	1.3	nC
Threshold Gate Charge	Q _{G(TH)}			0.2		
Gate-to-Source Charge	Q _{GS}			0.3		
Gate-to-Drain Charge	Q _{GD}			0.2		

SWITCHING CHARACTERISTICS (Note 3)

Turn-On Delay Time	t _{d(ON)}	V _{GS} = 4.5 V, V _{DD} = 5.0 V, I _D = 10 mA, R _G = 50 Ω		17		ns
Rise Time	t _r			23		
Turn-Off Delay Time	t _{d(OFF)}			94		
Fall Time	t _f			82		

DRAIN-SOURCE DIODE CHARACTERISTICS

Forward Diode Voltage	V _{SD}	V _{GS} = 0 V, I _S = 10 mA	T _J = 25°C	0.65	0.7	V
			T _J = 125°C	0.45		
Reverse Recovery Time	t _{RR}	V _{GS} = 0 V, dI _S /dt = 8.0 A/μs, I _S = 10 mA		12.4		ns

Product parametric performance is indicated in the Electrical Characteristics for the listed test conditions, unless otherwise noted. Product performance may not be indicated by the Electrical Characteristics if operated under different conditions.

2. Pulse Test: pulse width ≤ 300 μs, duty cycle ≤ 2%.
3. Switching characteristics are independent of operating junction temperatures.

NTJD4001N, NVTJD4001N

TYPICAL PERFORMANCE CURVES ($T_J = 25^\circ\text{C}$ unless otherwise noted)

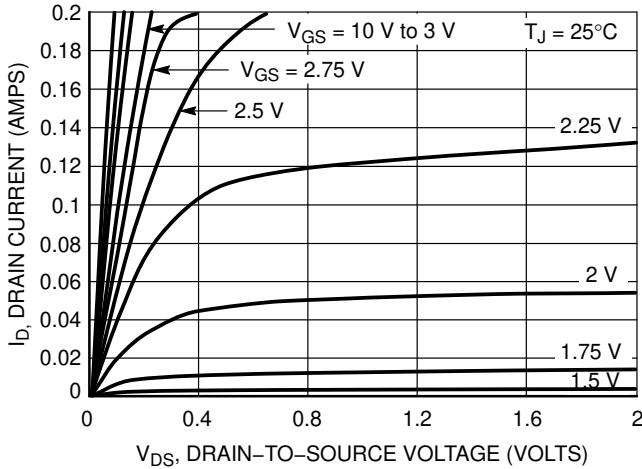

Figure 1. On-Region Characteristics

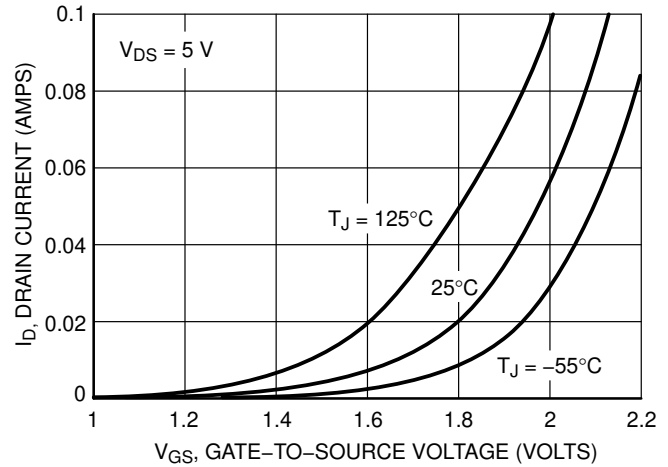

Figure 2. Transfer Characteristics

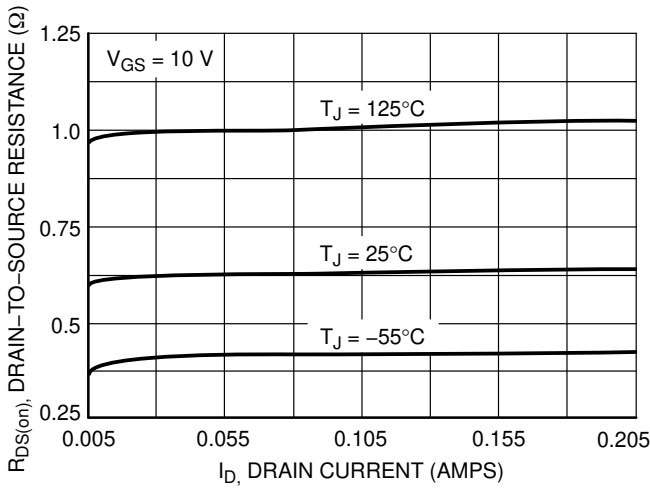

Figure 3. On-Resistance vs. Drain Current and Temperature

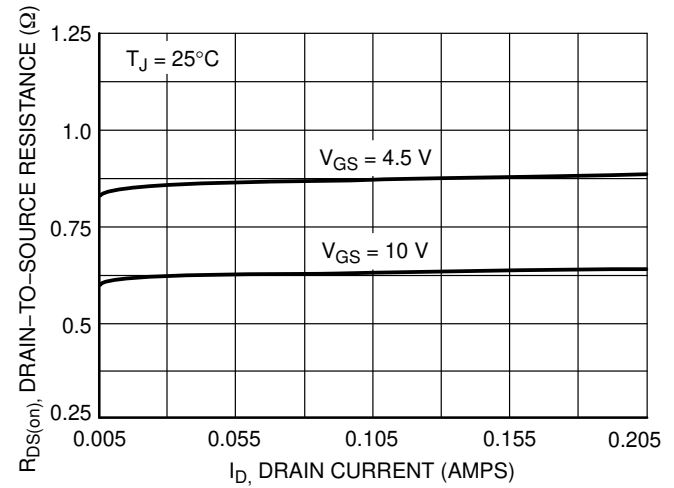

Figure 4. On-Resistance vs. Drain Current and Gate Voltage

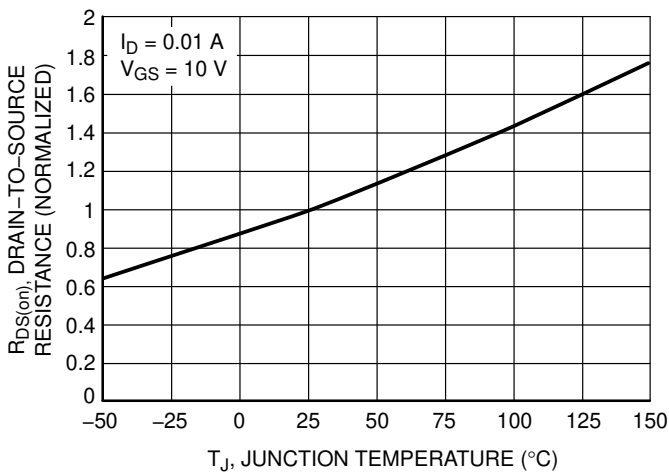

Figure 5. On-Resistance Variation with Temperature

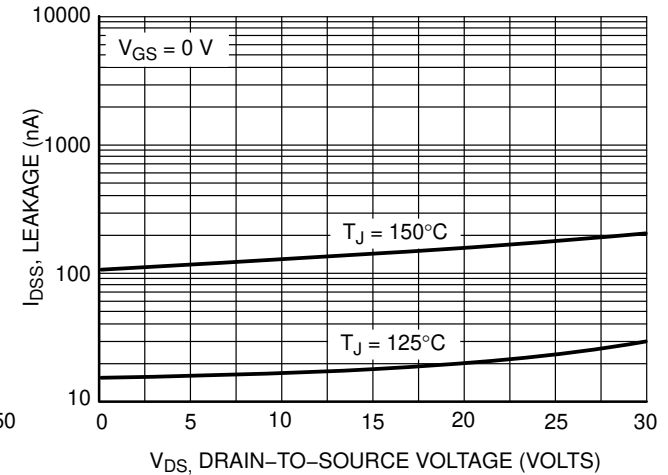
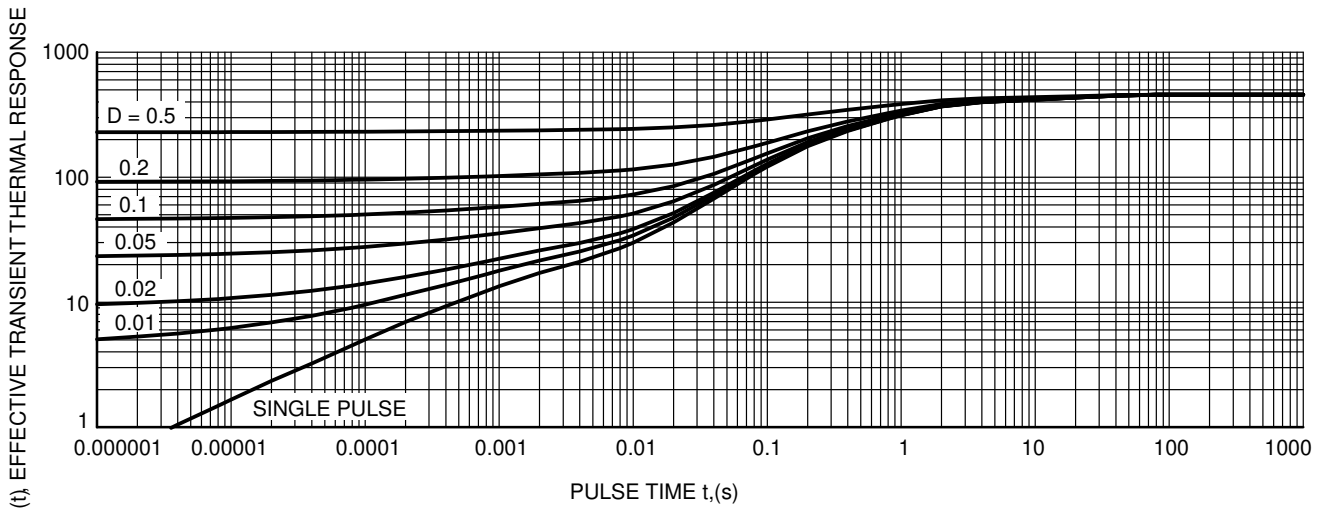
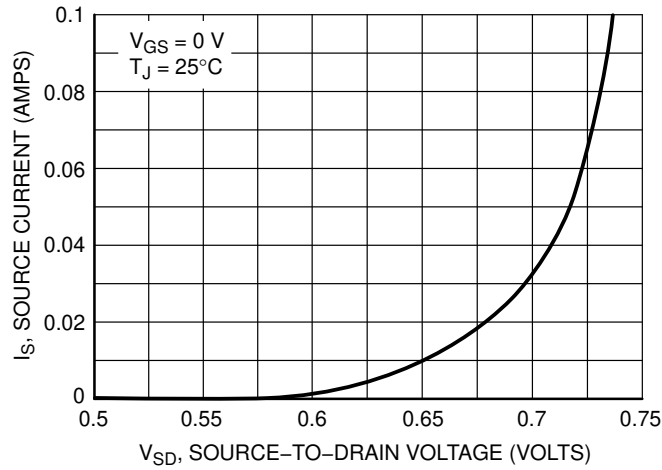
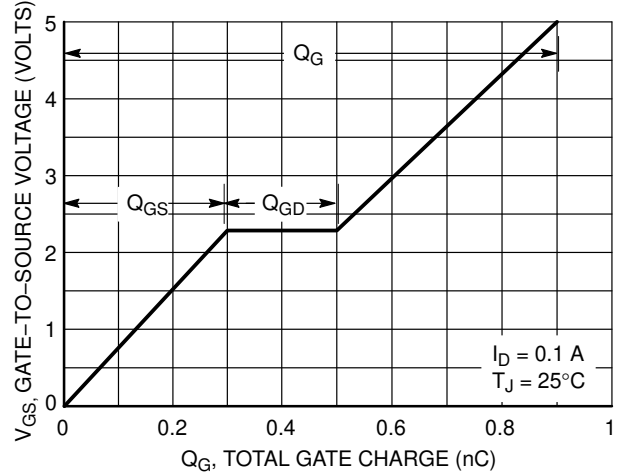
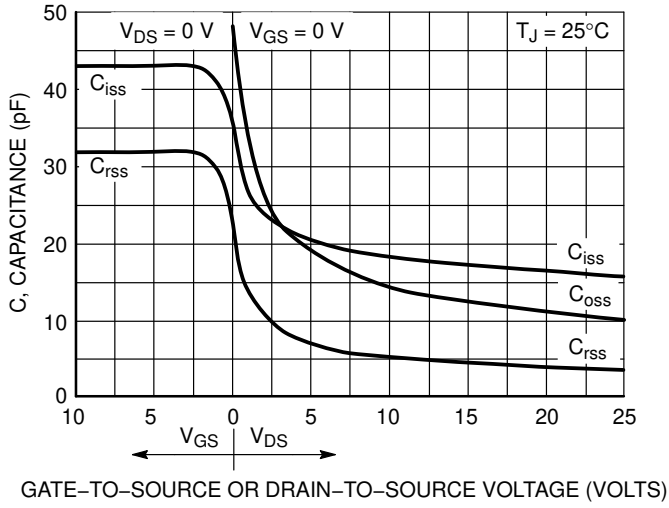

Figure 6. Drain-to-Source Leakage Current vs. Voltage

NTJD4001N, NVTJD4001N

TYPICAL PERFORMANCE CURVES ($T_J = 25^\circ\text{C}$ unless otherwise noted)



NTJD4001N, NVTJD4001N

PACKAGE DIMENSIONS

SC-88/SC70-6/SOT-363
CASE 419B-02
ISSUE W

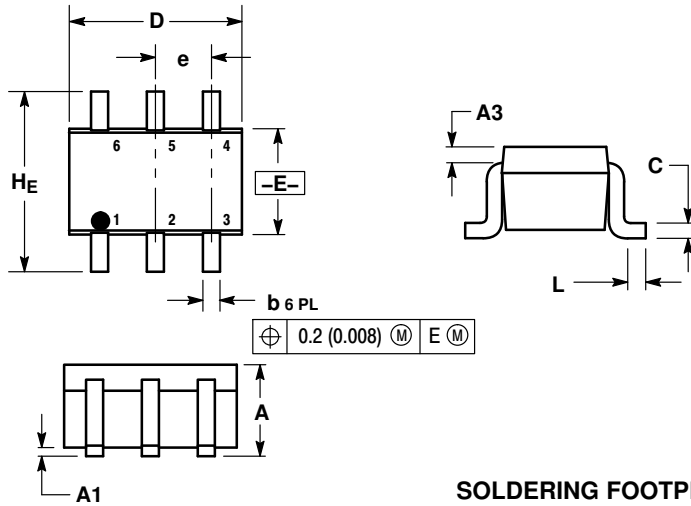

NOTES:

1. DIMENSIONING AND TOLERANCING PER ANSI Y14.5M, 1982.
2. CONTROLLING DIMENSION: INCH.
3. 419B-01 OBSOLETE, NEW STANDARD 419B-02.

DIM	MILLIMETERS			INCHES		
	MIN	NOM	MAX	MIN	NOM	MAX
A	0.80	0.95	1.10	0.031	0.037	0.043
A1	0.00	0.05	0.10	0.000	0.002	0.004
A3	0.20 REF			0.008 REF		
b	0.10	0.21	0.30	0.004	0.008	0.012
C	0.10	0.14	0.25	0.004	0.005	0.010
D	1.80	2.00	2.20	0.070	0.078	0.086
E	1.15	1.25	1.35	0.045	0.049	0.053
e	0.65 BSC			0.026 BSC		
L	0.10	0.20	0.30	0.004	0.008	0.012
HE	2.00	2.10	2.20	0.078	0.082	0.086

STYLE 26:

- PIN 1. SOURCE 1
2. GATE 1
3. DRAIN 2
4. SOURCE 2
5. GATE 2
6. DRAIN 1

SOLDERING FOOTPRINT*

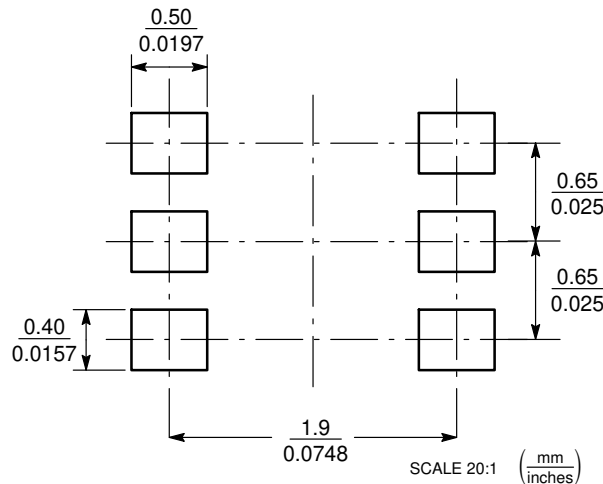

*For additional information on our Pb-Free strategy and soldering details, please download the ON Semiconductor Soldering and Mounting Techniques Reference Manual, SOLDERRM/D.

ON Semiconductor and the are registered trademarks of Semiconductor Components Industries, LLC (SCILLC) or its subsidiaries in the United States and/or other countries. SCILLC owns the rights to a number of patents, trademarks, copyrights, trade secrets, and other intellectual property. A listing of SCILLC's product/patent coverage may be accessed at www.onsemi.com/site/pdf/Patent-Marking.pdf. SCILLC reserves the right to make changes without further notice to any products herein. SCILLC makes no warranty, representation or guarantee regarding the suitability of its products for any particular purpose, nor does SCILLC assume any liability arising out of the application or use of any product or circuit, and specifically disclaims any and all liability, including without limitation special, consequential or incidental damages. "Typical" parameters which may be provided in SCILLC data sheets and/or specifications can and do vary in different applications and actual performance may vary over time. All operating parameters, including "Typicals" must be validated for each customer application by customer's technical experts. SCILLC does not convey any license under its patent rights nor the rights of others. SCILLC products are not designed, intended, or authorized for use as components in systems intended for surgical implant into the body, or other applications intended to support or sustain life, or for any other application in which the failure of the SCILLC product could create a situation where personal injury or death may occur. Should Buyer purchase or use SCILLC products for any such unintended or unauthorized application, Buyer shall indemnify and hold SCILLC and its officers, employees, subsidiaries, affiliates, and distributors harmless against all claims, costs, damages, and expenses, and reasonable attorney fees arising out of, directly or indirectly, any claim of personal injury or death associated with such unintended or unauthorized use, even if such claim alleges that SCILLC was negligent regarding the design or manufacture of the part. SCILLC is an Equal Opportunity/Affirmative Action Employer. This literature is subject to all applicable copyright laws and is not for resale in any manner.

PUBLICATION ORDERING INFORMATION

LITERATURE FULFILLMENT:

Literature Distribution Center for ON Semiconductor
P.O. Box 5163, Denver, Colorado 80217 USA
Phone: 303-675-2175 or 800-344-3860 Toll Free USA/Canada
Fax: 303-675-2176 or 800-344-3867 Toll Free USA/Canada
Email: orderlit@onsemi.com

N. American Technical Support: 800-282-9855 Toll Free
USA/Canada
Europe, Middle East and Africa Technical Support:
Phone: 421 33 790 2910
Japan Customer Focus Center
Phone: 81-3-5817-1050

ON Semiconductor Website: www.onsemi.com

Order Literature: <http://www.onsemi.com/orderlit>

For additional information, please contact your local Sales Representative