



Chipsmall Limited consists of a professional team with an average of over 10 year of expertise in the distribution of electronic components. Based in Hongkong, we have already established firm and mutual-benefit business relationships with customers from,Europe,America and south Asia,supplying obsolete and hard-to-find components to meet their specific needs.

With the principle of “Quality Parts,Customers Priority,Honest Operation,and Considerate Service”,our business mainly focus on the distribution of electronic components. Line cards we deal with include Microchip,ALPS,ROHM,Xilinx,Pulse,ON,Everlight and Freescale. Main products comprise IC,Modules,Potentiometer,IC Socket,Relay,Connector.Our parts cover such applications as commercial,industrial, and automotives areas.

We are looking forward to setting up business relationship with you and hope to provide you with the best service and solution. Let us make a better world for our industry!



Contact us

Tel: +86-755-8981 8866 Fax: +86-755-8427 6832

Email & Skype: info@chipsmall.com Web: www.chipsmall.com

Address: A1208, Overseas Decoration Building, #122 Zhenhua RD., Futian, Shenzhen, China



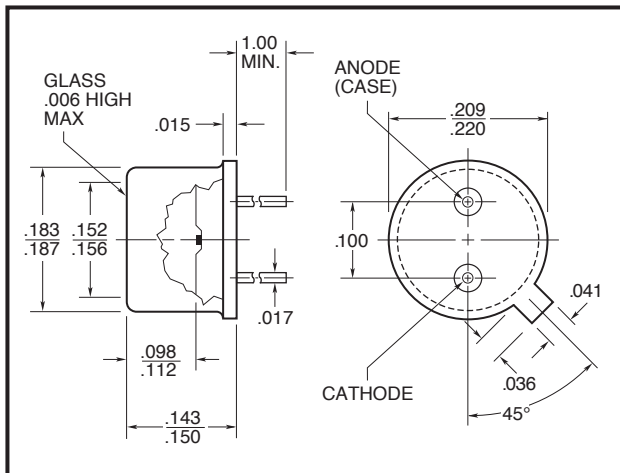

FEATURES

- Extended operating temperature range
- No internal coatings
- No derating or heat sink required to 80°C

All surfaces are gold plated. Dimensions are nominal values in inches unless otherwise specified. Window caps are welded to the case.



ELECTRO-OPTICAL CHARACTERISTICS AT 25°C

PARAMETERS	TEST CONDITIONS	MIN	TYP	MAX	UNITS
Total Power Output, P _o	I _F = 100mA	7	9		mW
Peak Emission Wavelength, λ _p	I _F = 50mA		880		nm
Spectral Bandwidth at 50%, Δλ			80		nm
Half Intensity Beam Angle, θ			80		Deg
Forward Voltage, V _F	I _F = 100mA		1.55	1.9	Volts
Reverse Breakdown Voltage, V _R	I _R = 10μA	5	30		Volts
Capacitance, C	V _R = 0V		17		pF
Rise Time			0.5		μsec
Fall Time			0.5		μSEC

ABSOLUTE MAXIMUM RATINGS AT 25°C CASE

Power Dissipation ¹	190mW
Continuous Forward Current	100mA
Peak Forward Current (10μs, 300Hz) ²	3A
Reverse Voltage	5V
Lead Soldering Temperature (1/16" from case for 10sec)	260°C

¹Derate per Thermal Derating Curve above 25°C

²Derate linearly above 25°C

THERMAL PARAMETERS

Storage and Operating Temperature Range	-65°C TO 150°C
Maximum Junction Temperature	150°C
Thermal Resistance, R _{THJA} ¹	370°C/W Typical
Thermal Resistance, R _{THJA} ²	120°C/W Typical

¹Heat transfer minimized by measuring in still air with minimum heat conducting through leads

²Air circulating at a rapid rate to keep case temperature at 25°C



750 Mitchell Road, Newbury Park, California 91320
 Phone: (805) 499-0335, Fax: (805) 499-8108
 Email: sales@optodiode.com, Website: www.optodiode.com

MAXIMUM RATINGS

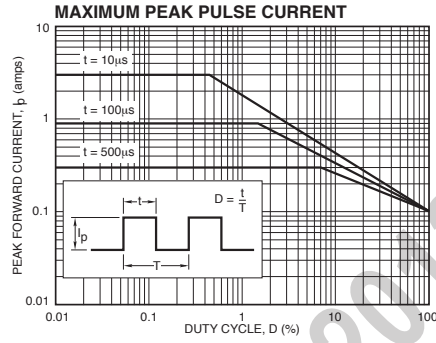
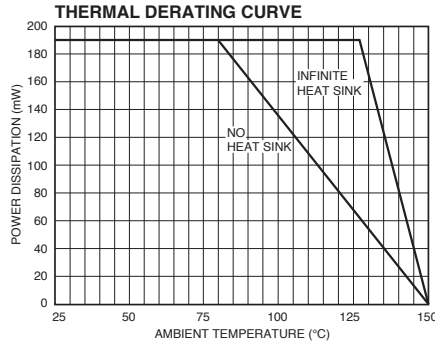

TYPICAL CHARACTERISTICS

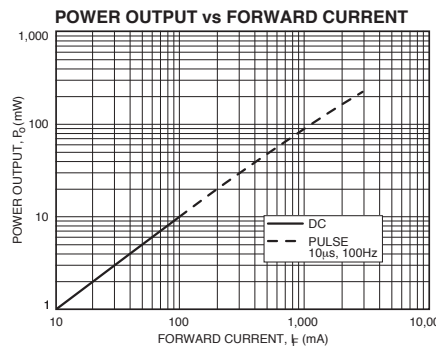
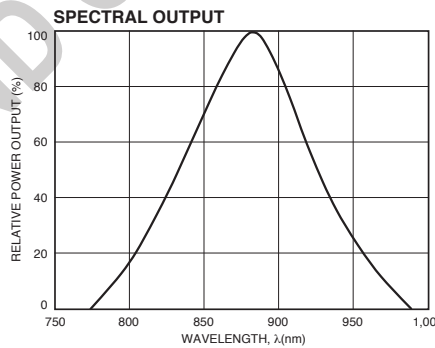
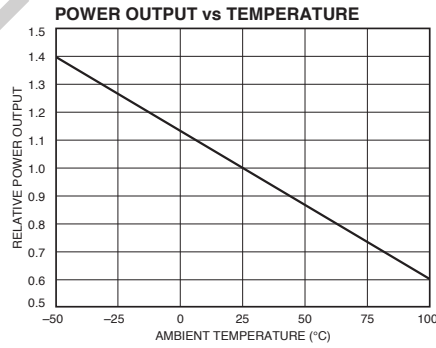
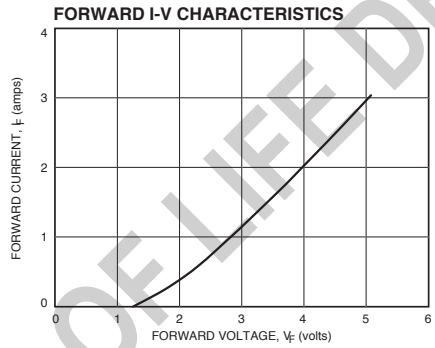
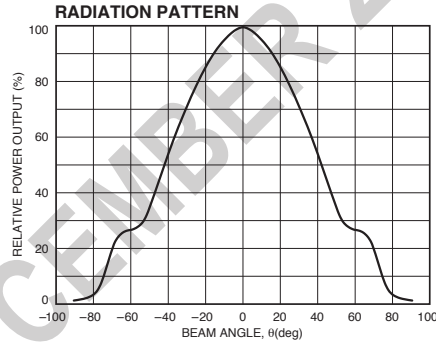
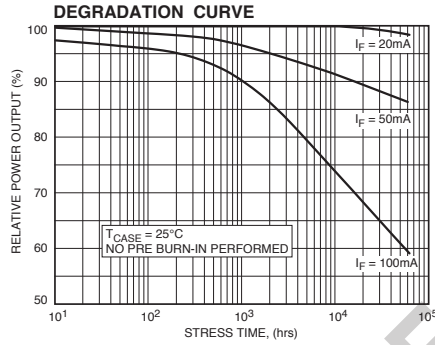

750 Mitchell Road, Newbury Park, California 91320
 Phone: (805) 499-0335, Fax: (805) 499-8108
 Email: sales@optodiode.com, Website: www.optodiode.com