



Chipsmall Limited consists of a professional team with an average of over 10 year of expertise in the distribution of electronic components. Based in Hongkong, we have already established firm and mutual-benefit business relationships with customers from,Europe,America and south Asia,supplying obsolete and hard-to-find components to meet their specific needs.

With the principle of “Quality Parts,Customers Priority,Honest Operation,and Considerate Service”,our business mainly focus on the distribution of electronic components. Line cards we deal with include Microchip,ALPS,ROHM,Xilinx,Pulse,ON,Everlight and Freescale. Main products comprise IC,Modules,Potentiometer,IC Socket,Relay,Connector.Our parts cover such applications as commercial,industrial, and automotives areas.

We are looking forward to setting up business relationship with you and hope to provide you with the best service and solution. Let us make a better world for our industry!



## Contact us

Tel: +86-755-8981 8866 Fax: +86-755-8427 6832

Email & Skype: info@chipsmall.com Web: www.chipsmall.com

Address: A1208, Overseas Decoration Building, #122 Zhenhua RD., Futian, Shenzhen, China



PART NUMBER  
OED-EL-8L

REV.  
D

REV.	E.C.N. NUMBER AND REVISION COMMENTS	DATE
A	E.C.N. #10247.	9.30.96
B	E.C.N. #10BRDR.	1.7.98
C	E.C.N. #10BRDR. & REDRAWN IN 3D.	12.31.02
D	E.C.N. #11561.	3.23.09

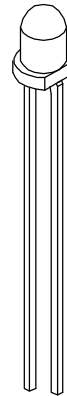
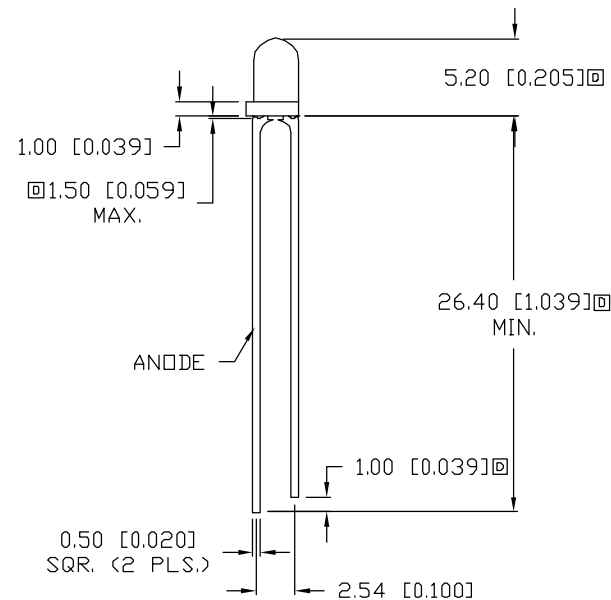
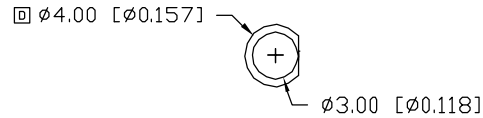

ELECTRO-OPTICAL CHARACTERISTICS  $T_A=25^\circ\text{C}$   $I_f=20\text{mA}$

PARAMETER	MIN	TYP	MAX	UNITS	TEST COND
PEAK WAVELENGTH		940		nm	
SPECTRAL BANDWIDTH		45		nm	
FORWARD VOLTAGE		1.2	1.5	$V_f$	$I_f=20\text{mA}$
		1.4*	1.8*	$V_f$	$I_f=100\text{mA}$
		2.6*	4.0*	$V_f$	$I_f=1\text{A}$
REVERSE VOLTAGE			5.0	$V_r$	$I_r=10\mu\text{A}$
RADIANT INTENSITY	4.0	5.6		mW/SR	$I_f=20\text{mA}$
		35*		mW/SR	$I_f=100\text{mA}$
		390*		mW/SR	$I_f=1\text{A}$
HALF ANGLE		$\pm 17.5$		degrees	

EPOXY LENS FINISH: WATER CLEAR

\*  $t_p < 100\mu\text{s}$ ,  $TP/T=1\%$

LIMITS OF SAFE OPERATION AT  $25^\circ\text{C}$

PARAMETER	MAX	UNITS
PEAK FORWARD CURRENT*	1	A
STEADY CURRENT	100	mA
POWER DISSIPATION	150	mW
DERATE FROM $25^\circ\text{C}$	-1.6	$\text{mW}/^\circ\text{C}$
OPERATING TEMP.	-40 TO +85	$^\circ\text{C}$
STORAGE TEMP.	-40 TO +85	$^\circ\text{C}$
SOLDERING TEMP.	+260	$^\circ\text{C}$
2.0mm FROM BODY		3 SEC. MAX

\*  $t_p < 100\mu\text{s}$ ,  $tp/T=1\%$



\*UNLESS OTHERWISE SPECIFIED TOLERANCES PER DECIMAL PRECISION ARE: X=±1 (±0.039), X.X=±0.5 (±0.020), X.XX=±0.25 (±0.010), X.XXX=±0.127 (±0.005). LEAD SIZE=±0.05 (±0.002), LEAD LENGTH=±0.75 (±0.030). MIN= +DECIMAL PRECISION -0.00 MAX= +0.00 -DECIMAL PRECISION

REV. D	PART NUMBER OED-EL-8L
-----------	--------------------------

**CONFIDENTIAL INFORMATION**  
THE INFORMATION CONTAINED IN THIS DOCUMENT IS THE PROPERTY OF LUMEX INC. EXCEPT AS SPECIFICALLY AUTHORIZED IN WRITING BY LUMEX INC., THE HOLDER OF THIS DOCUMENT SHALL KEEP ALL INFORMATION CONTAINED HEREIN CONFIDENTIAL AND SHALL PROTECT SAME IN WHOLE OR IN PART FROM DISCLOSURE AND DISSEMINATION TO ALL THIRD PARTIES.



290 E. HELEN ROAD  
PALATINE, IL 60067-6976  
PHONE: +1.847.359.2790  
US WEB: www.lumex.com  
TW WEB: www.lumex.com.tw

T-3mm, 940nm INFRARED EMITTER, WATER CLEAR LENS.

**RELIABILITY NOTE**  
OUR MANY YEARS OF EXPERIENCE DATA ACCUMULATION INDICATE THAT SOLDER HEAT IS A MAJOR CAUSE OF EARLY AND FUTURE FAILURE. PLEASE PAY ATTENTION TO YOUR SOLDERING PROCESS.

DRAWN BY: BC	CHECKED BY:	APPROVED BY:	DATE: 4.21.93
			PAGE: 1 OF 1
			SCALE: N/A

PART NUMBER  
OED-EL-8L

REV.  
D

REV.

SEE PAGE 1.

DATE

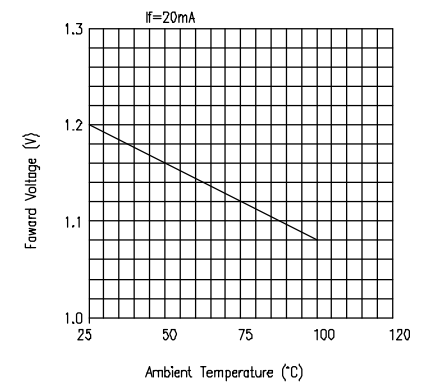
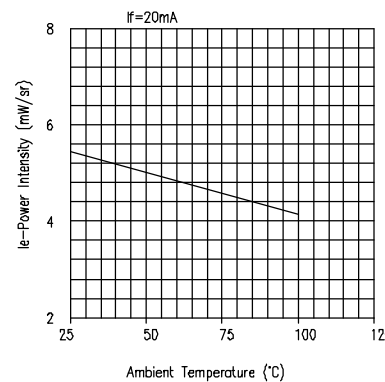
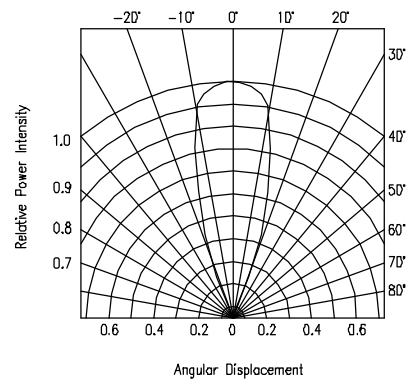
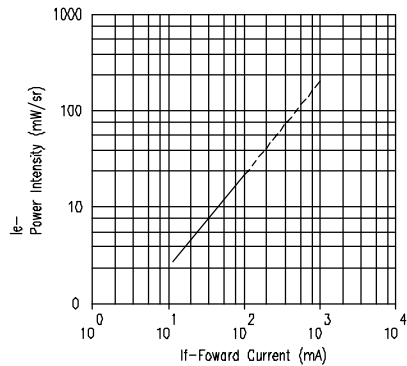
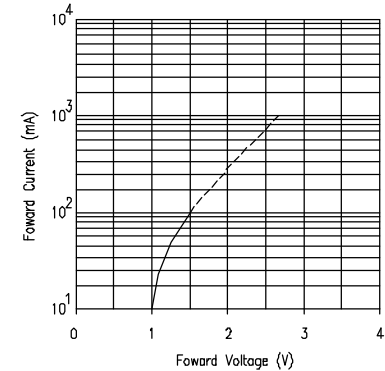
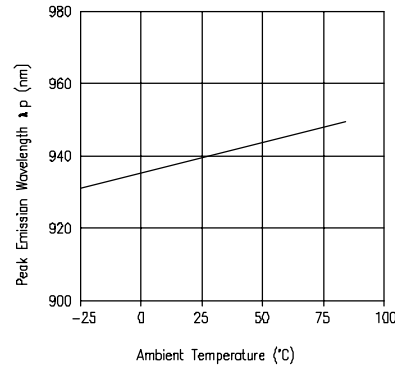
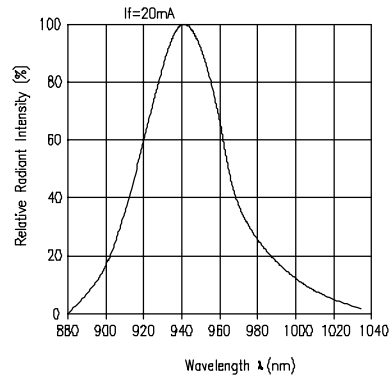
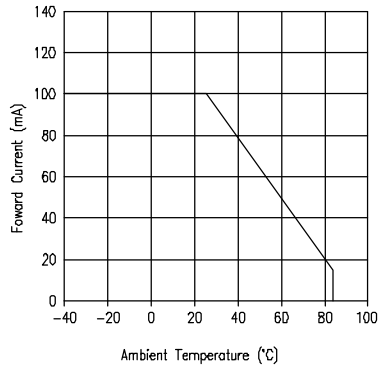

\*UNLESS OTHERWISE SPECIFIED TOLERANCES PER DECIMAL PRECISION ARE: X=±1 (±0.039), X.X=±0.5 (±0.020), X.XX=±0.25 (±0.010), X.XXX=±0.127 (±0.005). LEAD SIZE=±0.05 (±0.002), LEAD LENGTH=±0.75 (±0.030). MIN.= +DECIMAL PRECISION -0.00 MAX.= +0.00 -DECIMAL PRECISION

REV.  
D

PART NUMBER  
OED-EL-8L

**CONFIDENTIAL INFORMATION**  
THE INFORMATION CONTAINED IN THIS DOCUMENT IS THE PROPERTY OF LUMEX INC. EXCEPT AS SPECIFICALLY AUTHORIZED IN WRITING BY LUMEX INC., THE HOLDER OF THIS DOCUMENT SHALL KEEP ALL INFORMATION CONTAINED HEREIN CONFIDENTIAL AND SHALL PROTECT SAME IN WHOLE OR IN PART FROM DISCLOSURE AND DISSEMINATION TO ALL THIRD PARTIES.



290 E. HELEN ROAD  
PALATINE, IL 60067-6976  
PHONE: +1.847.359.2790  
US WEB: www.lumex.com  
TW WEB: www.lumex.com.tw



T-3mm, 940nm INFRARED EMITTER, WATER CLEAR LENS.

**RELIABILITY NOTE**  
OUR MANY YEARS OF EXPERIENCE DATA ACCUMULATION INDICATE THAT SOLDER HEAT IS A MAJOR CAUSE OF EARLY AND FUTURE FAILURE. PLEASE PAY ATTENTION TO YOUR SOLDERING PROCESS.

DRAWN BY:

BC

CHECKED BY:

APPROVED BY:

DATE: 4.21.93

PAGE: 2 OF 2

SCALE: N/A