



Chipsmall Limited consists of a professional team with an average of over 10 year of expertise in the distribution of electronic components. Based in Hongkong, we have already established firm and mutual-benefit business relationships with customers from,Europe,America and south Asia,supplying obsolete and hard-to-find components to meet their specific needs.

With the principle of “Quality Parts,Customers Priority,Honest Operation,and Considerate Service”,our business mainly focus on the distribution of electronic components. Line cards we deal with include Microchip,ALPS,ROHM,Xilinx,Pulse,ON,Everlight and Freescale. Main products comprise IC,Modules,Potentiometer,IC Socket,Relay,Connector.Our parts cover such applications as commercial,industrial, and automotives areas.

We are looking forward to setting up business relationship with you and hope to provide you with the best service and solution. Let us make a better world for our industry!



Contact us

Tel: +86-755-8981 8866 Fax: +86-755-8427 6832

Email & Skype: info@chipsmall.com Web: www.chipsmall.com

Address: A1208, Overseas Decoration Building, #122 Zhenhua RD., Futian, Shenzhen, China





OSRAM GOLDEN DRAGON®

20mm LENSES AND HOLDERS



OPERATING CONDITIONS

- ▲ 105° C max temperature

MATERIALS/FINISH

- ▲ Lenses are optical grade PMMA acrylic
- ▲ Holders are made of durable polycarbonate

MECHANICAL DIMENSIONS

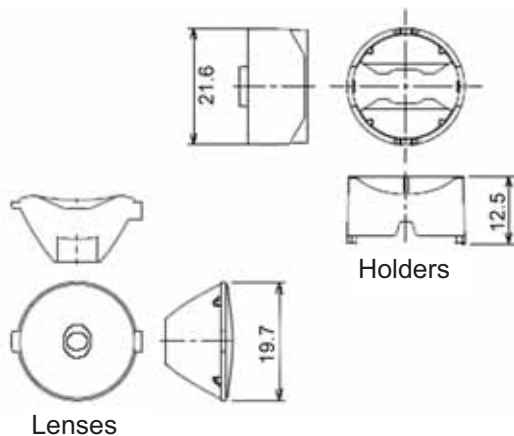

Dialight reserves the right to make changes at any time in order to supply the best product possible.

FEATURES / BENEFITS

- ▲ For Osram Golden Dragon LEDs
- ▲ Available in spot, medium, wide and oval lenses
- ▲ Snap-in sub-lens
- ▲ Greater than 85% efficiency

ORDERING INFORMATION

HOLDERS			
Dialight P/N	Reference P/N	Description	
OHGDBK	OH-GD-BK	Osram Golden Dragon LEDs - Black	
OHGDCL	OH-GD-CL	Osram Golden Dragon LEDs - Clear	
OHGDWH	OH-GD-WH	Osram Golden Dragon LEDs - White	
LENS			
Dialight P/N	Reference P/N	Description	Degree*
OP005	OP-005	Spot Lens	5°
OP015	OP-015	Medium Lens	15°
OP025	OP-025	Wide Lens	25°
OP520	OP-520	Oval Lens	5° X 20°

*All angles refer to half divergence



Dialight Corporation

1501 Route 34 South • Farmingdale, NJ 07727 USA

Tel: (1) 732-919-3119 • Fax: (1) 732-751-5778 • www.dialight.com



MDEXLUMOGD_A

PHOTOMETRIC DATA

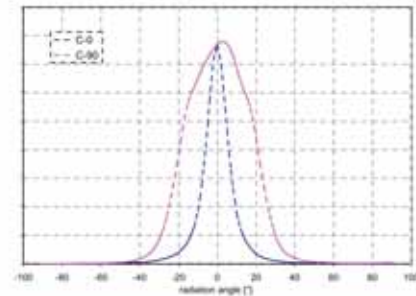
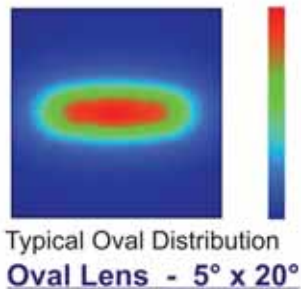
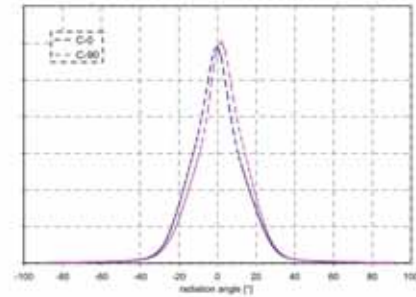
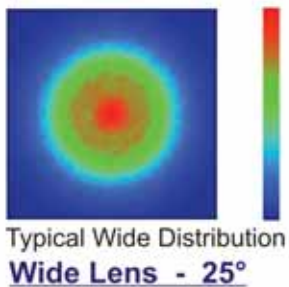
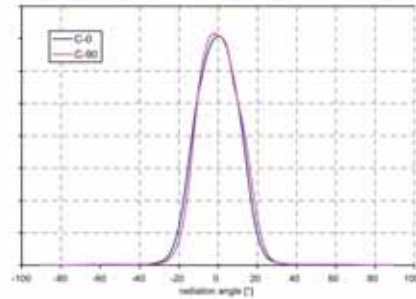
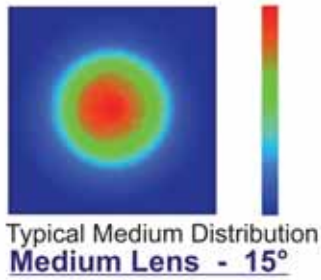
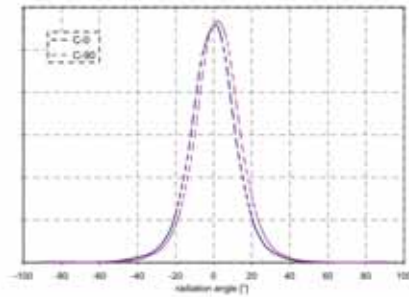
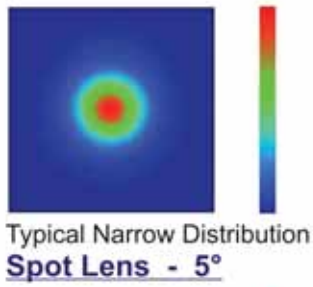

Dialight reserves the right to make changes at any time in order to supply the best product possible.



Dialight Corporation

1501 Route 34 South • Farmingdale, NJ 07727 USA

Tel: (1) 732-919-3119 • Fax: (1) 732-751-5778 • www.dialight.com



MDEXLUMOGD_A