



Chipsmall Limited consists of a professional team with an average of over 10 year of expertise in the distribution of electronic components. Based in Hongkong, we have already established firm and mutual-benefit business relationships with customers from,Europe,America and south Asia,supplying obsolete and hard-to-find components to meet their specific needs.

With the principle of “Quality Parts,Customers Priority,Honest Operation,and Considerate Service”,our business mainly focus on the distribution of electronic components. Line cards we deal with include Microchip,ALPS,ROHM,Xilinx,Pulse,ON,Everlight and Freescale. Main products comprise IC,Modules,Potentiometer,IC Socket,Relay,Connector.Our parts cover such applications as commercial,industrial, and automotives areas.

We are looking forward to setting up business relationship with you and hope to provide you with the best service and solution. Let us make a better world for our industry!



Contact us

Tel: +86-755-8981 8866 Fax: +86-755-8427 6832

Email & Skype: info@chipsmall.com Web: www.chipsmall.com

Address: A1208, Overseas Decoration Building, #122 Zhenhua RD., Futian, Shenzhen, China



Hermetic Infrared Emitting Diode

OP230 Series



Features:

- Focused and non-focused optical light pattern
- Enhanced temperature range
- TO-46 hermetically sealed package
- Mechanically and spectrally matched to other Optek devices
- Choice of power ranges
- Choice of narrow or wide irradiance pattern



Description:

Each device in this series is a gallium aluminum arsenide (GaAlAs) infrared emitting diode, mounted in a hermetic metal TO-46 housing. The gallium aluminum arsenide feature provides a higher radiated output than gallium arsenide at the same forward current.

Each **OP231**, **OP232**, **OP233**, **OP234** and **OP235** device is lensed to provide a narrow beam angle (18°) between half power points. The 890 nm wavelength closely matches the spectral response of silicon phototransistors, while the narrow beam angle – combined with the specified radiant intensity of the OP231 series – facilitates easy design in beam interrupt applications in conjunction with the OP800 or OP598 series photosensors. *The OP231 series is mechanically and spectrally matched to OP800, OP593 and OP598 phototransistors.*

Each **OP231W**, **OP232W**, **OP233W**, **OP234W** and **OP235W** device is lensed to provide a wide beam angle (50°) between half power points. The 890 nm wavelength closely matches the spectral response of silicon photo-transistors, while the wide beam angle provides relatively even illumination over a large area. *The OP231W is mechanically and spectrally matched to the OP800WSL and OP830SL series devices.*

Please refer to Application Bulletins 208 and 210 for additional design information and reliability (degradation) data.

Custom electrical, wire and cabling and connectors are available. Contact your local representative or OPTEK for more information.

Applications:

- Non-contact reflective object sensor
- Assembly line automation
- Machine automation
- Machine safety
- End of travel sensor
- Door sensor

Ordering Information				
Part Number	LED Peak Wavelength	Output Power (mW/cm ²) Min / Max	Total Beam Angle	Lead Length
OP231	890 nm	1.5 / NA	18°	0.50"
OP232		2.0 / 6.0		
OP233		3.0 / NA		
OP234		5.0 / NA		
OP235		6.0 / NA		
OP231W	890 nm	1.5 / NA	50°	
OP232W		3.5 / 7.0		
OP233W		5.0 / NA		
OP234W		5.0 / NA		
OP235W	850 nm	6.0 / NA		

General Note

TT Electronics reserves the right to make changes in product specification without notice or liability. All information is subject to TT Electronics' own data and is considered accurate at time of going to print.

OPTEK Technology, Inc.
1645 Wallace Drive, Carrollton, TX 75006 | Ph: +1 972 323 2200
www.optekinc.com | www.ttelectronics.com

Hermetic Infrared Emitting Diode

OP230 Series



OP231, OP232, OP233, OP234, OP235

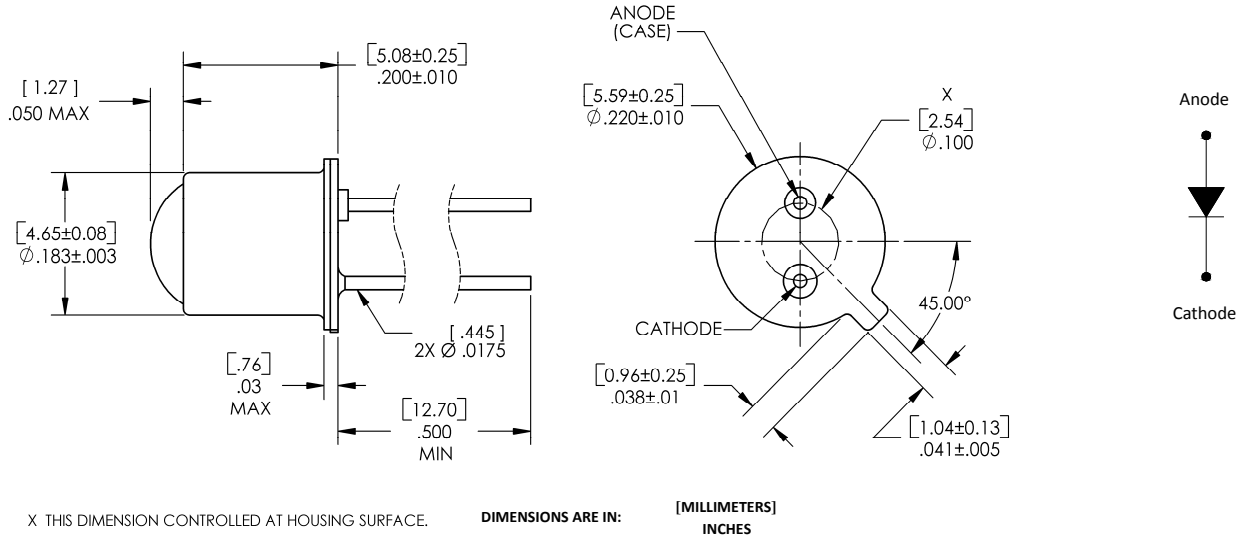

OP231W, OP232W, OP233W, OP234W, OP235W

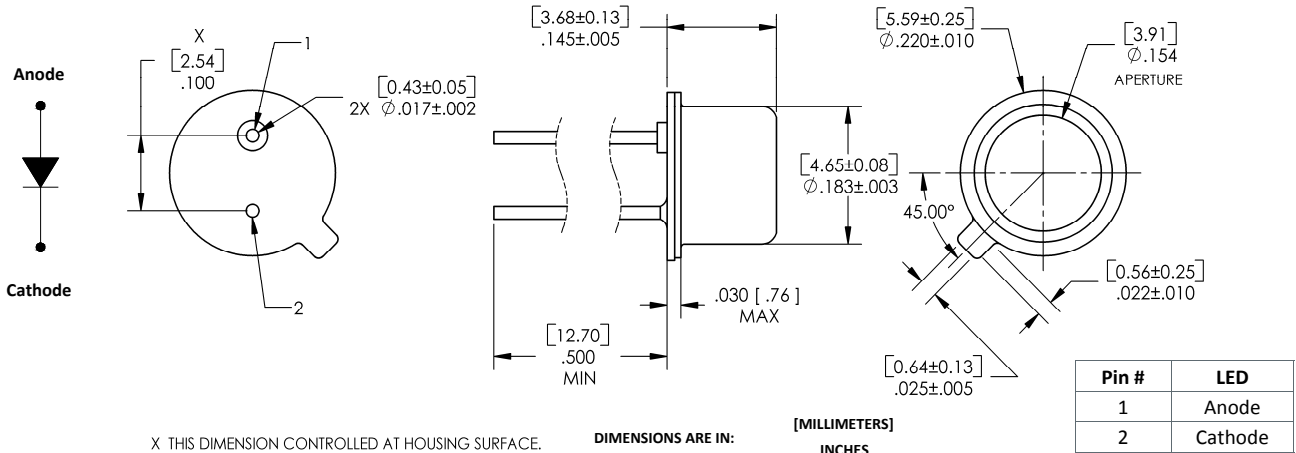

Absolute Maximum Ratings (T_A=25°C unless otherwise noted)

Storage Temperature Range	-65° C to +150° C
Operating Temperature Range	-65° C to +125° C
Reverse Voltage	2.0 A
Continuous Forward Current	100 mA
Peak Forward Current	10.0 A
Lead Soldering Temperature [1/16 inch (1.6 mm) from case for 5 seconds with soldering iron]	260° C ⁽¹⁾⁽²⁾
Power Dissipation	200 mW ⁽³⁾

General Note
 TT Electronics reserves the right to make changes in product specification without notice or liability. All information is subject to TT Electronics' own data and is considered accurate at time of going to print.

OPTEK Technology, Inc.
 1645 Wallace Drive, Carrollton, TX 75006 | Ph: +1 972 323 2200
www.optekinc.com | www.ttelectronics.com

Hermetic Infrared Emitting Diode

OP230 Series



Electrical Characteristics ($T_A = 25^\circ\text{C}$ unless otherwise noted)

SYMBOL	PARAMETER	MIN	TYP	MAX	UNITS	TEST CONDITIONS
--------	-----------	-----	-----	-----	-------	-----------------

Input Diode

$E_{E(APTa)}$	Apertured Radiant Incidence					
	OP231	1.5	-	-	mW/ cm ²	OP231 Series $I_F = 100\text{ mA}^{(3),(4)}$ Aperture = 0.250" Distance = 1.429"
	OP232	2.0	-	6.0		
	OP233	3.0	-	-		
	OP234	5.0	-	-		
	OP235	6.0	-	-		
	OP231W	1.5	-	-	mW/ cm ²	OP231W Series $I_F = 100\text{ mA}^{(3),(4)}$ Aperture = 0.250" Distance = 0.466"
	OP232W	3.5	-	7.0		
	OP233W	5.0	-	-		
	OP234W	5.0	-	-		
OP235W	6.0	-	-			
P_O	Radiant Power Output				mW	$I_F = 100\text{ mA}^{(3),(4)}$
	OP231	-	6.0	-		
	OP232	-	8.0	-		
	OP233	-	10.0	-		
V_F	Forward Voltage	-	-	2.0	V	$I_F = 100\text{ mA}^{(3)}$
I_R	Reverse Current	-	-	100	μA	$V_R = 2.0\text{ V}$
λ_P	Wavelength at Peak Emission				nm	$I_F = 10\text{ mA}$
	OP231, OP232, OP233	-	890	-		
	OP234, OP235	-	850	-		
β	Spectral Bandwidth between Half Power Points	-	80	-	nm	$I_F = 10\text{ mA}$
$\Delta\lambda_P/\Delta T$	Spectral Shift with Temperature	-	+0.30	-	nm/ $^\circ\text{C}$	$I_F = \text{Constant}$
θ_{HP}	Emission Angle at Half Power Points				Degree	$I_F = 100\text{ mA}$
	OP231 - OP235	-	18	-		
	OP231W - OP231W	-	50	-		
t_r	Output Rise Time	-	500	-	ns	$I_{F(PK)} = 100\text{ mA}$, $PW = 10\text{ }\mu\text{s}$, and D.C. = 10.0%
t_f	Output Fall Time	-	250	-	ns	

Notes:

1. RMA flux is recommended. Duration can be extended to 10 seconds maximum when flow soldering.
2. Derate linearly 2.0 mW/ $^\circ\text{C}$ above 25 $^\circ\text{C}$.
3. Measurement made with 100 μs pulse measured at the trailing edge of the pulse with a duty cycle of 0.1% and an $I_F = 100\text{ mA}$.
4. For the OP231 series, $E_{E(APT)}$ is a measurement of the average radiant intensity within the cone formed by the measurement surface, a radius of 1.429" (36.30 mm) measured from the lens side of the tab to the sensing surface and a sensing surface of 0.250" (6.35 mm) in diameter forming a 10 $^\circ$ cone. For the OP231W series, $E_{E(APT)}$ is a measurement of the average radiant intensity within the cone formed by the measurement surface, a radius of 0.466" (11.84 mm) measured from the lens side of the tab to the sensing surface and a sensing surface of 0.250" (6.35 mm) in diameter forming a 10 $^\circ$ cone. $E_{E(APT)}$ is not necessarily uniform within the measured area.

General Note

TT Electronics reserves the right to make changes in product specification without notice or liability. All information is subject to TT Electronics' own data and is considered accurate at time of going to print.

OPTEK Technology, Inc.
1645 Wallace Drive, Carrollton, TX 75006 | Ph: +1 972 323 2200
www.optekinc.com | www.ttelectronics.com

Hermetic Infrared Emitting Diode

OP230 Series



OP231, OP232, OP233 (including "W" devices)

Forward Voltage vs Forward Current vs Temperature

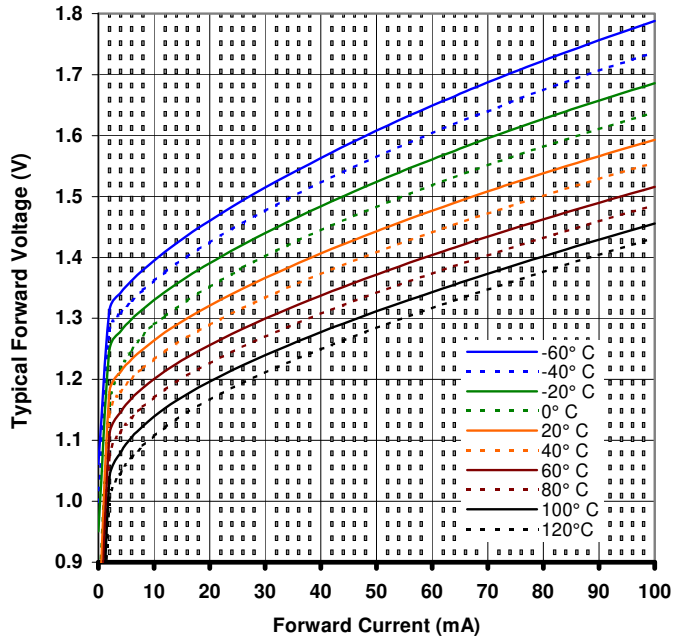

Optical Power vs I_F vs Temperature

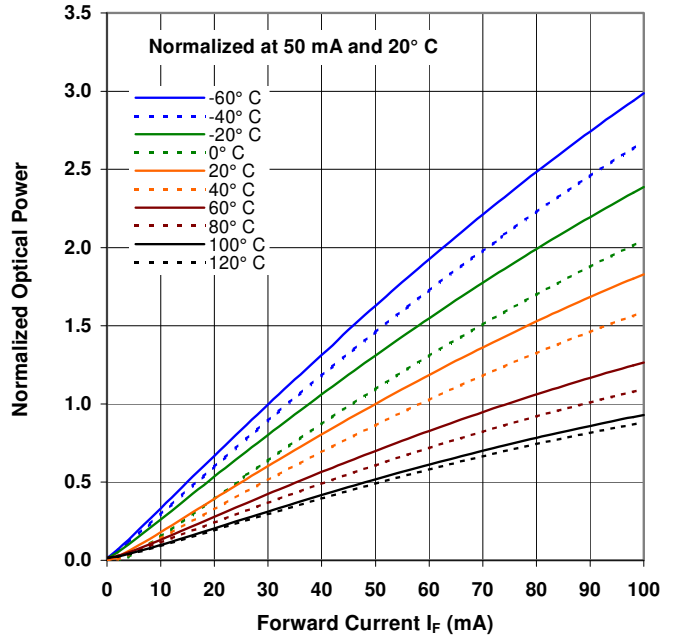

Distance vs Output Power vs Forward Current

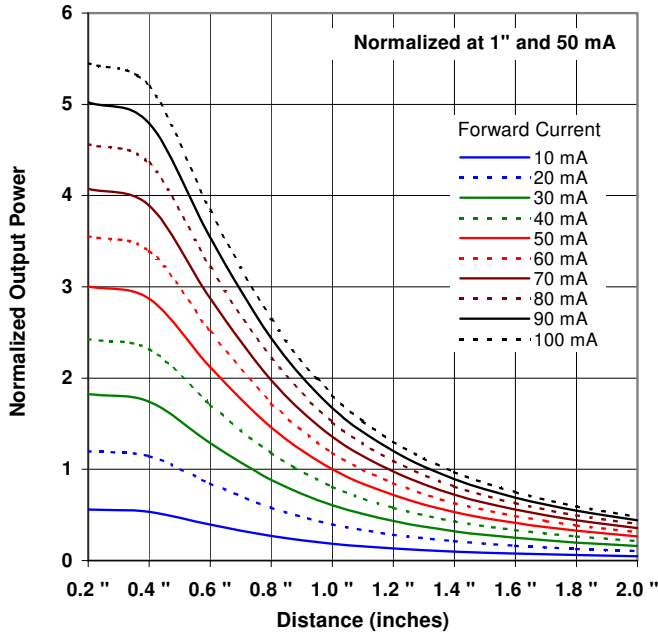

Relative Radiant Intensity vs. Angular Displacement

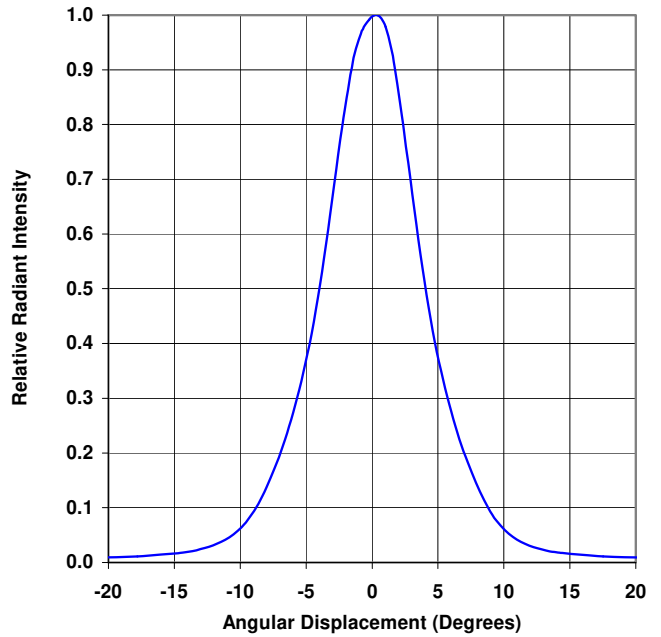

General Note
 TT Electronics reserves the right to make changes in product specification without notice or liability. All information is subject to TT Electronics' own data and is considered accurate at time of going to print.

OPTEK Technology, Inc.
 1645 Wallace Drive, Carrollton, TX 75006 | Ph: +1 972.323.2200
www.optekinc.com | www.ttelectronics.com

Hermetic Infrared Emitting Diode

OP230 Series



OP234, OP234W

Forward Voltage vs Forward Current vs Temperature

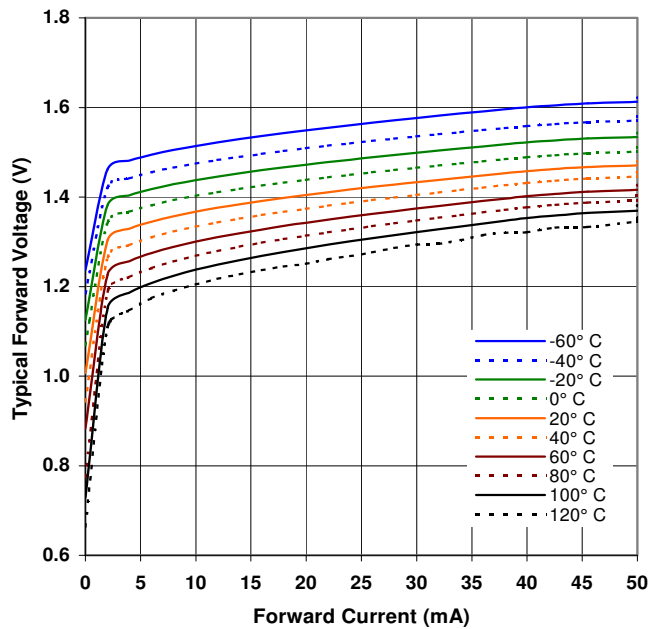

Optical Power vs Forward Current vs Temperature

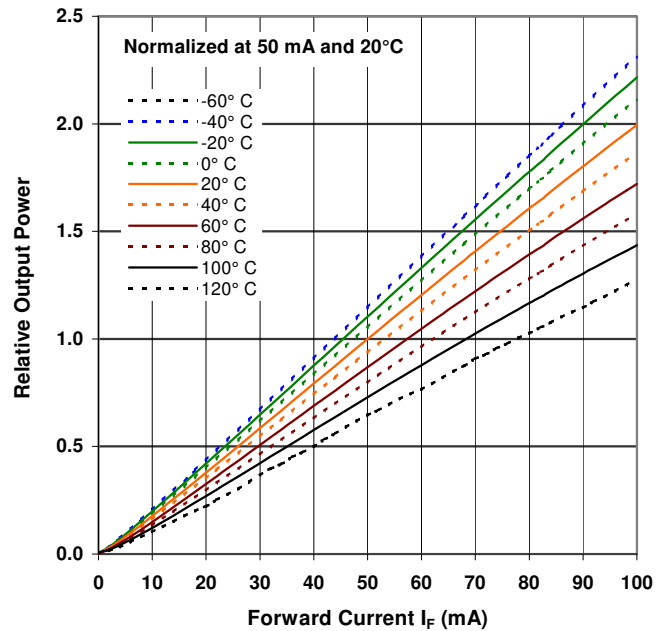

Distance vs Output Power vs Forward Current

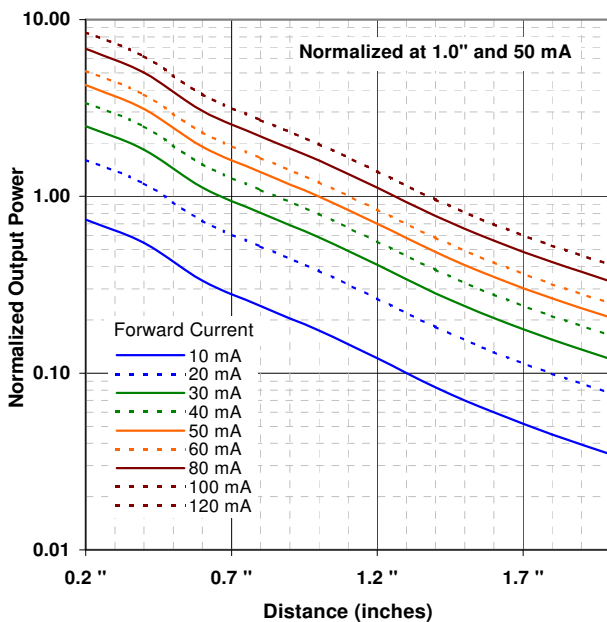

Relative Radiant Intensity vs Angular Displacement

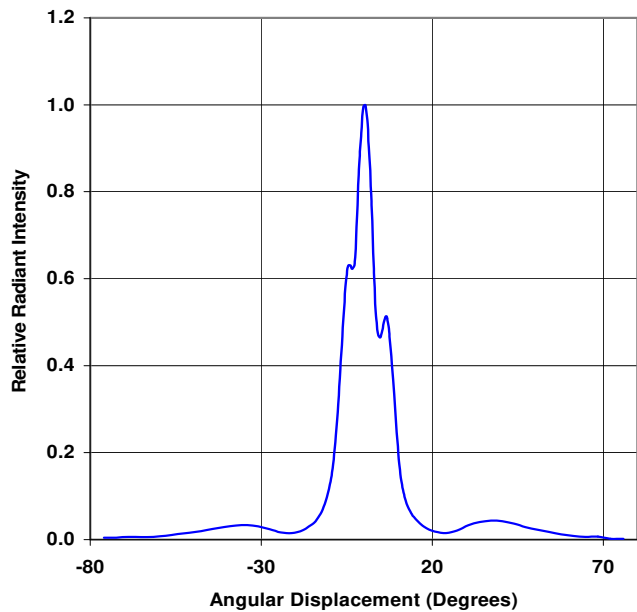

General Note
 TT Electronics reserves the right to make changes in product specification without notice or liability. All information is subject to TT Electronics' own data and is considered accurate at time of going to print.

OPTEK Technology, Inc.
 1645 Wallace Drive, Carrollton, TX 75006
 Ph: +1 972 323 2200
www.optekinc.com | www.ttelectronics.com

Hermetic Infrared Emitting Diode

OP230 Series



OP235, OP235W

Forward Voltage vs Forward Current vs Temperature

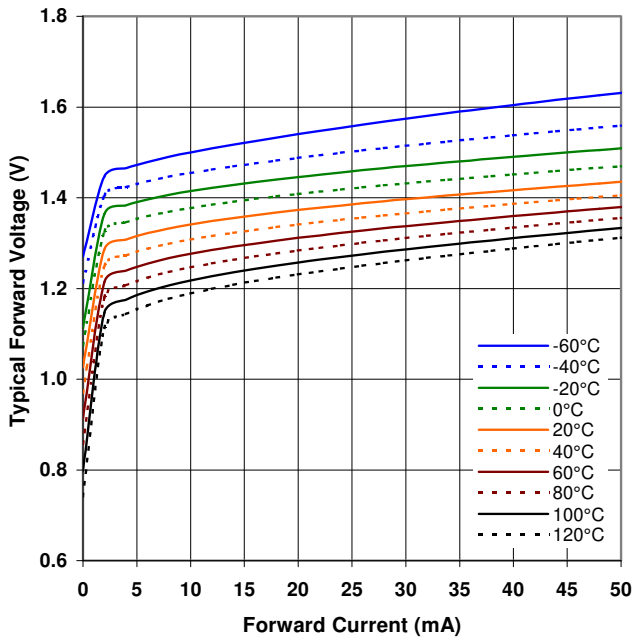

Optical Power vs Forward Current vs Temperature

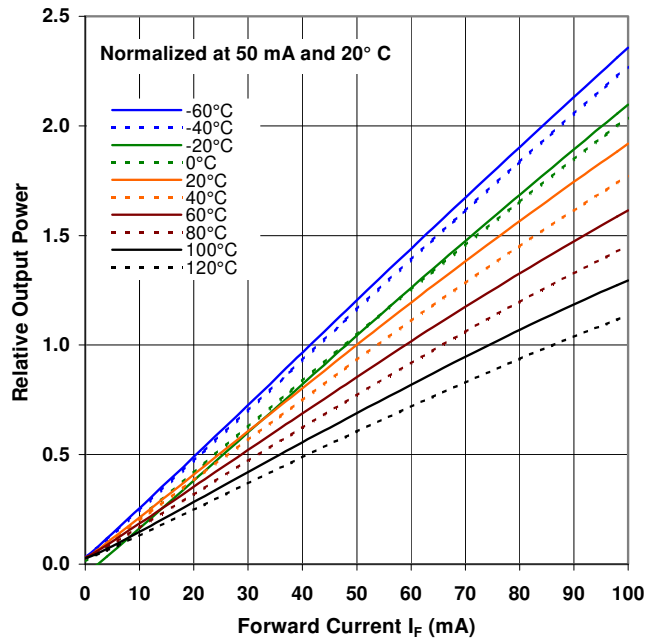

Distance vs Output Power vs Forward Current

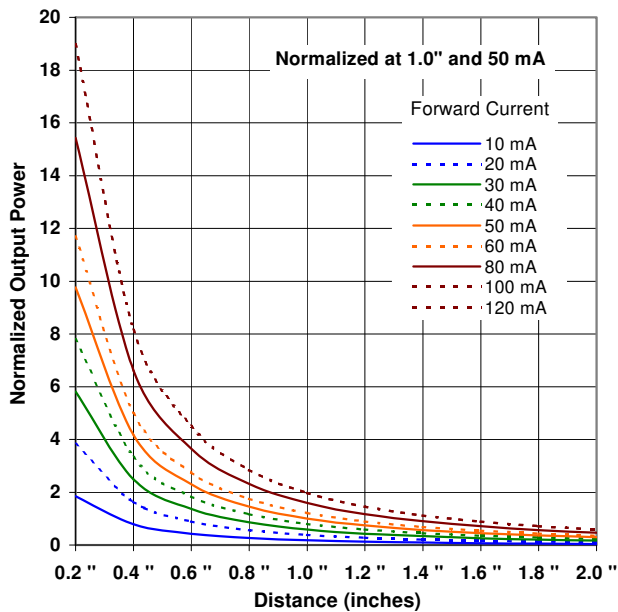

General Note
 TT Electronics reserves the right to make changes in product specification without notice or liability. All information is subject to TT Electronics' own data and is considered accurate at time of going to print.

OPTEK Technology, Inc.
 1645 Wallace Drive, Carrollton, TX 75006 | Ph: +1 972.323.2200
www.optekinc.com | www.ttelectronics.com