



Chipsmall Limited consists of a professional team with an average of over 10 year of expertise in the distribution of electronic components. Based in Hongkong, we have already established firm and mutual-benefit business relationships with customers from,Europe,America and south Asia,supplying obsolete and hard-to-find components to meet their specific needs.

With the principle of “Quality Parts,Customers Priority,Honest Operation,and Considerate Service”,our business mainly focus on the distribution of electronic components. Line cards we deal with include Microchip,ALPS,ROHM,Xilinx,Pulse,ON,Everlight and Freescale. Main products comprise IC,Modules,Potentiometer,IC Socket,Relay,Connector.Our parts cover such applications as commercial,industrial, and automotives areas.

We are looking forward to setting up business relationship with you and hope to provide you with the best service and solution. Let us make a better world for our industry!



Contact us

Tel: +86-755-8981 8866 Fax: +86-755-8427 6832

Email & Skype: info@chipsmall.com Web: www.chipsmall.com

Address: A1208, Overseas Decoration Building, #122 Zhenhua RD., Futian, Shenzhen, China



Infrared Light Emitting Diode in Miniature SMD Package

OP251

- Internal Lens
- High Power
- 1206 Package Size
- 880nm Wavelength



PRELIMINARY

The OP251 is a GaAlAs infrared LEDs mounted in a miniature SMT package. The device incorporates an integral molded lens which enables a tight beam angle and provides an even emission pattern. This device is packaged in a 1206 size chip carrier that is compatible with most automated mounting equipment. The OP251 is mechanically and spectrally matched to the OP520 series phototransistors.

Applications

- Non-Contact Position Sensing
- Datum detection
- Machine automation
- Optical encoders

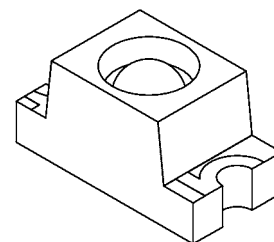
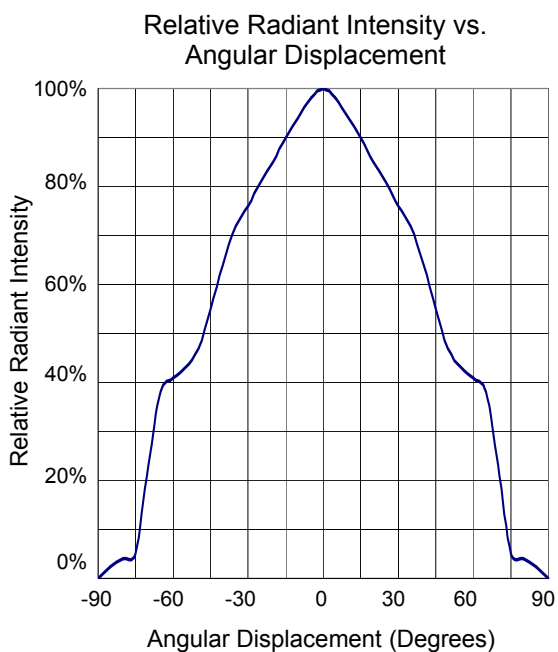

OP251



LEAD FREE

Optek reserves the right to make changes at any time in order to improve design and to supply the best product possible.

Absolute Maximum Ratings

$T_A = 25^\circ\text{C}$ unless otherwise noted

Storage Temperature Range	-40° C to +85° C
Operating Temperature Range	-25° C to +85° C
Lead Soldering Temperature	260° C ⁽¹⁾
Reverse Voltage	30 V
Continuous Forward Current	50 mA
Power Dissipation	130 mW ⁽²⁾

Notes:

- Solder time less than 5 seconds at temperature extreme.
- De-rate linearly at 2.17 mW/° C above 25° C.

Electrical Characteristics ($T_A = 25^\circ\text{C}$ unless otherwise noted)

SYMBOL	PARAMETER	MIN	TYP	MAX	UNITS	CONDITIONS
$E_{e(\text{APT})}$	Apertured Radiant Incidence	0.3			mW/cm ²	$I_F = 20\text{mA}^{(3)}$
V_F	Forward Voltage			1.5	V	$I_F = 20\text{mA}$
I_R	Reverse Current			100	μA	$V_R = 2.0\text{V}$
λ_P	Peak Emission Wavelength		890		nm	$I_F = 10\text{mA}$
Θ_{HP}	Emission Angle at Half Power Points		105		Deg.	$I_F = 20\text{mA}$
t_r, t_f	Rise and Fall Time			500	ns	$I_{F(\text{PEAK})} = 100\text{mA}$, PW = 10μs, 10% D.C.

- $E_{e(\text{APT})}$ is a measurement of the apertured radiant incidence upon a sensing area 0.081" (2.06mm) in diameter, perpendicular to and centered on the mechanical axis of the lens, and 0.590" (14.99mm) from the measurement surface. $E_{e(\text{APT})}$ is not necessarily uniform within the measured area.

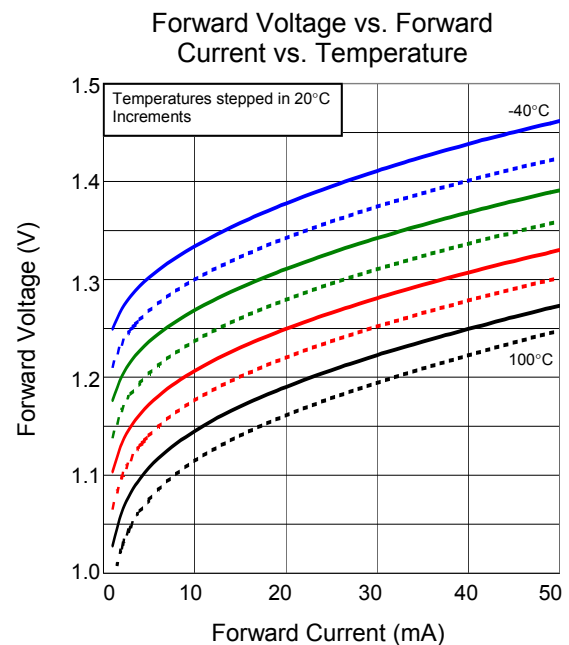
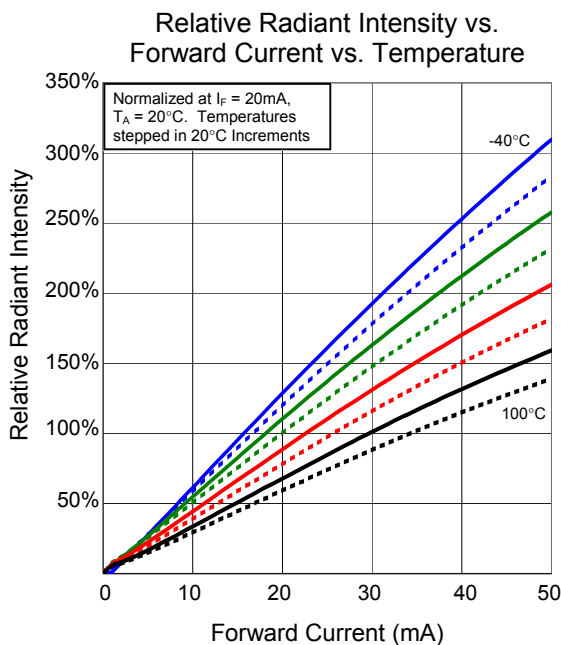

SMD Infrared LED

OP251

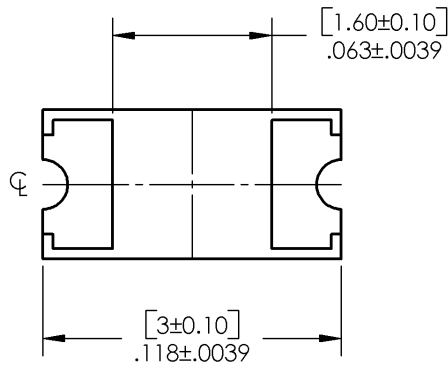
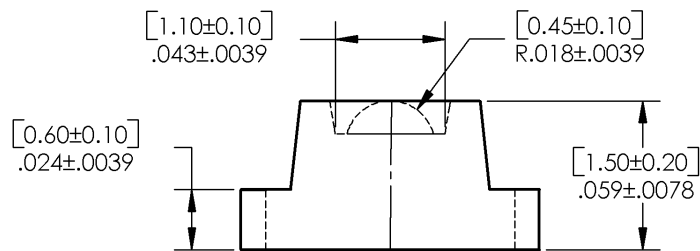
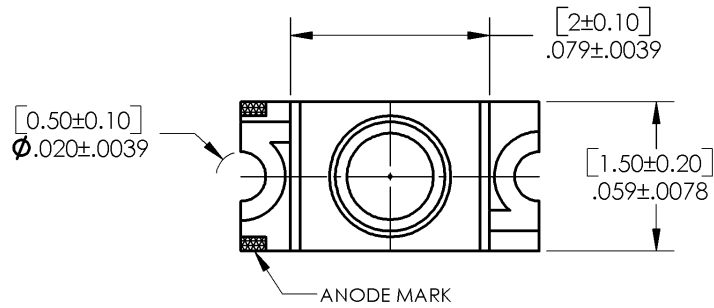

PIN	FUNCTION
1	Anode
2	Cathode

DIMENSIONS ARE IN INCHES AND [MILLIMETERS].

RECOMMENDED SOLDER PADS

