



Chipsmall Limited consists of a professional team with an average of over 10 year of expertise in the distribution of electronic components. Based in Hongkong, we have already established firm and mutual-benefit business relationships with customers from,Europe,America and south Asia,supplying obsolete and hard-to-find components to meet their specific needs.

With the principle of “Quality Parts,Customers Priority,Honest Operation,and Considerate Service”,our business mainly focus on the distribution of electronic components. Line cards we deal with include Microchip,ALPS,ROHM,Xilinx,Pulse,ON,Everlight and Freescale. Main products comprise IC,Modules,Potentiometer,IC Socket,Relay,Connector.Our parts cover such applications as commercial,industrial, and automotives areas.

We are looking forward to setting up business relationship with you and hope to provide you with the best service and solution. Let us make a better world for our industry!



Contact us

Tel: +86-755-8981 8866 Fax: +86-755-8427 6832

Email & Skype: info@chipsmall.com Web: www.chipsmall.com

Address: A1208, Overseas Decoration Building, #122 Zhenhua RD., Futian, Shenzhen, China



Plastic Infrared Emitting Diode

OP265FAA Series

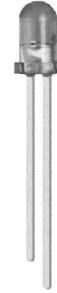

Features:

- T-1 (3 mm) package style
- Narrow irradiance pattern
- Dome lens
- Higher power output than GaAs at equivalent drive currents
- 850 nm diode

Description:

Each device in the **OP265FAA** series is a high intensity gallium arsenide infrared emitting diode (GaAIAs) that is molded in an IR transmissive clear epoxy package with a dome lens. Devices feature a narrow source irradiance pattern and a variety of electrical characteristics. The small T-1 package style makes these devices ideal for space-limited applications.

These devices are mechanically and spectrally matched to other OPTEK products as follows:

OP265 devices conform to the OP505 and OP535 series devices.

Please refer to Application Bulletins 208 and 210 for additional design information and reliability (degradation) data.

Applications:

- Space-limited applications
- Applications requiring coupling efficiency
- Battery-operated or voltage-limited applications

Ordering Information					
Part Number	LED Peak Wavelength	Output Power (mW/cm ²) Min / Max	I _f (mA) Typ / Max	Total Beam Angle	Lead Length
OP265FAA	850 nm	5.5 / NA	20 / 50	18°	0.50"
OP265FAB		7.5 / 12.5			
OP265FAC		11.5 / 16.5			

DIMENSIONS ARE IN: [MILLIMETERS]
INCHES

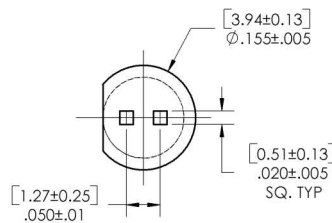
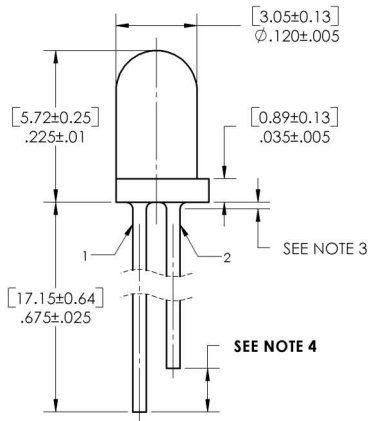

DISCRETE PIN-OUT

- 1 CATHODE
- 2 ANODE



IMPORTANT:
For identification purposes, ANODE lead is shorter than the CATHODE lead in order to differentiate this product from regular OP265 and/or OP313.

NOTES:

1. OUTSIDE DISCRETE SHELL IS POLYSULFONE P1700 CLEAR.
2. THIS LED IS BUILT WITH A 850nm CHIP.
3. MAX ALLOWABLE EPOXY MINISCUS IS 0.030.
4. FOR IDENTIFICATION PURPOSES, ANODE LEAD IS .065 ± .035 SHORTER THAN THE CATHODE LEAD.

Pin #	LED
1	Cathode
2	Anode

CONTAINS POLYSULFONE

To avoid stress cracking, we suggest using ND Industries' **Vibra-Tite** for thread-locking. **Vibra-Tite** evaporates fast without causing structural failure in OPTEK's molded plastics.



General Note

TT Electronics reserves the right to make changes in product specification without notice or liability. All information is subject to TT Electronics' own data and is considered accurate at time of going to print.

OPTEK Technology, Inc.
1645 Wallace Drive, Carrollton, TX 75006 | Ph: +1 972 323 2200
www.optekinc.com | www.ttelectronics.com

Plastic Infrared Emitting Diode

OP265FAA Series



Electrical Specifications

Absolute Maximum Ratings ($T_A = 25^\circ\text{C}$ unless otherwise noted)	
Storage and Operating Temperature Range	-40°C to $+100^\circ\text{C}$
Reverse Voltage	2.0 V
Continuous Forward Current	50 mA
Peak Forward Current (1 μs pulse width, 300 pps)	3.0 A
Lead Soldering Temperature [1/16 inch (1.6 mm) from case for 5 seconds with soldering iron]	$260^\circ\text{C}^{(1)}$
Power Dissipation	$100\text{ mW}^{(2)}$

Notes:

1. RMA flux is recommended. Duration can be extended to 10 second maximum when flow soldering. A maximum of 20 grams force may be applied to the leads when soldering.
2. Derate linearly at $1.33\text{ mW}/^\circ\text{C}$ above 25°C .
3. $E_{E(\text{APT})}$ is a measurement of the average apertured radiant incidence upon a sensing area $0.081''$ (2.06 mm) in diameter, perpendicular to and centered on the mechanical axis of the lens and $0.590''$ (14.99 mm) from the measurement surface. $E_{E(\text{APT})}$ is not necessarily uniform within the measured area.

Electrical Characteristics ($T_A = 25^\circ\text{C}$ unless otherwise noted)						
SYMBOL	PARAMETER	MIN	TYP	MAX	UNITS	TEST CONDITIONS
Input Diode						
$E_{E(\text{APT})}$	Apertured Radiant Incidence OP265FAA OP265FAB OP265FAC	5.50 7.50 11.50	- - -	- 12.5 16.5	mW/cm^2	$I_F = 20\text{ mA}$ Aperture = $0.081''$ diameter Distance = $0.590''$ from seating surface to aperture surface
V_F	Forward Voltage	-	-	1.80	V	$I_F = 20\text{ mA}$
I_R	Reverse Current	-	10	-	μA	$V_R = 10\text{ V}$
λ_P	Wavelength at Peak Emission	-	850	-	nm	$I_F = 10\text{ mA}$
$\Delta\lambda_P/\Delta T$	Spectral Shift with Temperature	-	± 0.18	-	$\text{nm}/^\circ\text{C}$	$I_F = \text{Constant}$
θ_{HP}	Emission Angle at Half Power Points	-	18	-	Degree	$I_F = 20\text{ mA}$
t_r	Output Rise Time	-	10	-	ns	$I_{F(\text{PK})} = 100\text{ mA}$, $\text{PW} = 10\ \mu\text{s}$, $\text{D.C.} = 10.0\%$
t_f	Output Fall Time	-	10	-	ns	

General Note

TT Electronics reserves the right to make changes in product specification without notice or liability. All information is subject to TT Electronics' own data and is considered accurate at time of going to print.

OPTEK Technology, Inc.
1645 Wallace Drive, Carrollton, TX 75006 | Ph: +1 972 323 2200
www.optekinc.com | www.ttelectronics.com

Plastic Infrared Emitting Diode

OP265FAA Series



Performance OP265F (AA, AB, AC)

Forward Voltage vs Forward Current vs Temperature

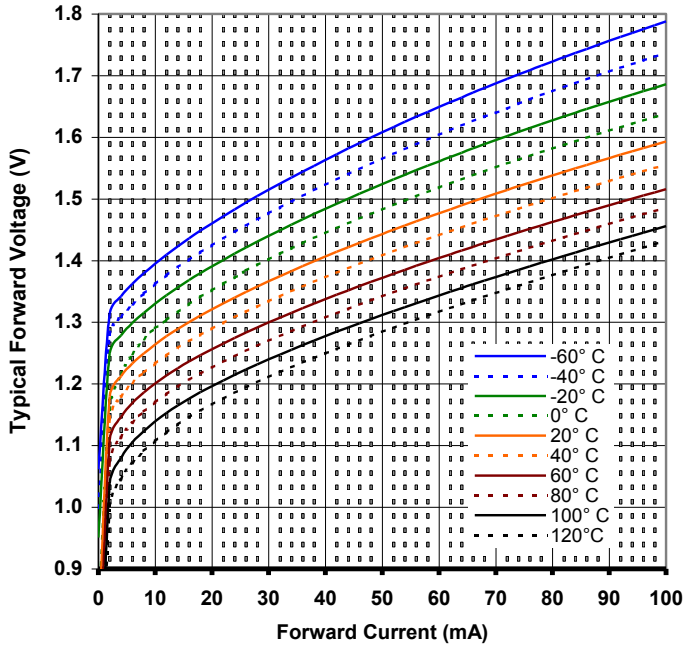

Optical Power vs I_F vs Temperature

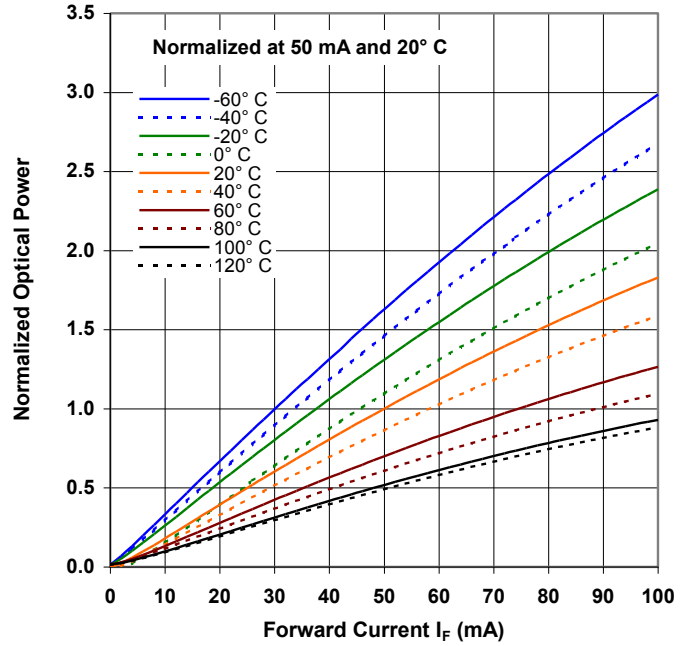

Distance vs Output Power vs Forward Current

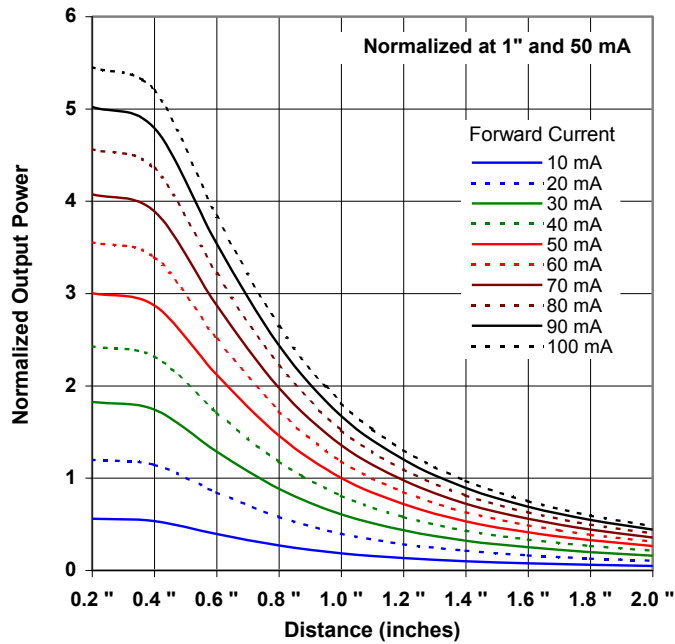

Relative Radiant Intensity vs. Angular Displacement

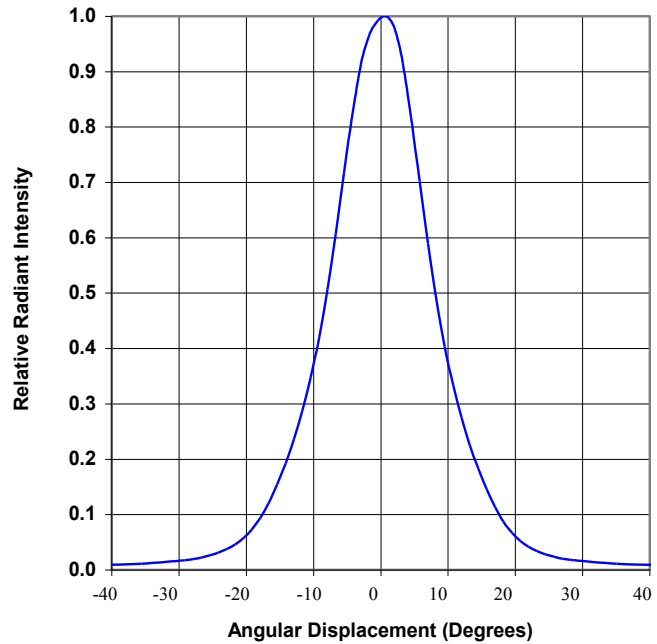

General Note

TT Electronics reserves the right to make changes in product specification without notice or liability. All information is subject to TT Electronics' own data and is considered accurate at time of going to print.

OPTEK Technology, Inc.
1645 Wallace Drive, Carrollton, TX 75006 | Ph: +1 972 323 2200
www.optekinc.com | www.ttelectronics.com