



Chipsmall Limited consists of a professional team with an average of over 10 year of expertise in the distribution of electronic components. Based in Hongkong, we have already established firm and mutual-benefit business relationships with customers from,Europe,America and south Asia,supplying obsolete and hard-to-find components to meet their specific needs.

With the principle of “Quality Parts,Customers Priority,Honest Operation,and Considerate Service”,our business mainly focus on the distribution of electronic components. Line cards we deal with include Microchip,ALPS,ROHM,Xilinx,Pulse,ON,Everlight and Freescale. Main products comprise IC,Modules,Potentiometer,IC Socket,Relay,Connector.Our parts cover such applications as commercial,industrial, and automotives areas.

We are looking forward to setting up business relationship with you and hope to provide you with the best service and solution. Let us make a better world for our industry!



## Contact us

Tel: +86-755-8981 8866 Fax: +86-755-8427 6832

Email & Skype: info@chipsmall.com Web: www.chipsmall.com

Address: A1208, Overseas Decoration Building, #122 Zhenhua RD., Futian, Shenzhen, China



## FEATURES

- High slew rate: 9 V/μs**
- Wide bandwidth: 4 MHz**
- Low supply current: 250 μA/amplifier maximum**
- Low offset voltage: 3 mV maximum**
- Low bias current: 100 pA maximum**
- Fast settling time**
- Common-mode range includes V+**
- Unity-gain stable**
- 14-ball wafer level chip scale for quad**

## APPLICATIONS

- Active filters**
- Fast amplifiers**
- Integrators**
- Supply current monitoring**

## GENERAL DESCRIPTION

The **OP282/OP482** dual and quad operational amplifiers feature excellent speed at exceptionally low supply currents. The slew rate is typically 9 V/μs with a supply current of less than 250 μA per amplifier. These unity-gain stable amplifiers have a typical gain bandwidth of 4 MHz.

The JFET input stage of the **OP282/OP482** ensures that the bias current is typically a few picoamps and is less than 500 pA over the full temperature range. The offset voltage is less than 3 mV for the dual amplifier and less than 4 mV for the quad amplifier.

With a wide output swing (within 1.5 V of each supply), low power consumption, and high slew rate, the **OP282/OP482** are ideal for battery-powered systems or power-restricted applications. An input common-mode range that includes the positive supply makes the **OP282/OP482** an excellent choice for high-side signal conditioning.

The **OP282/OP482** are specified over the extended industrial temperature range. The **OP282** is available in the standard 8-lead, narrow SOIC and MSOP packages. The **OP482** is available in the PDIP and narrow SOIC packages, as well as a 14-ball WLCSP.

### PIN CONNECTIONS

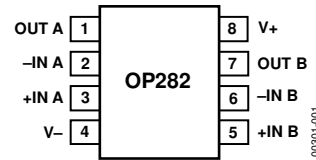

Figure 1. 8-Lead, Narrow-Body SOIC (S-Suffix) [R-8]



Figure 2. 8-Lead MSOP [RM-8]

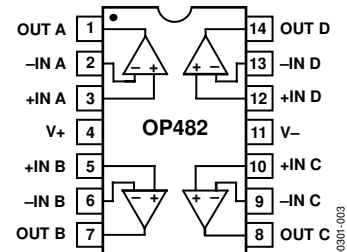

Figure 3. 14-Lead PDIP (P-Suffix) [N-14]

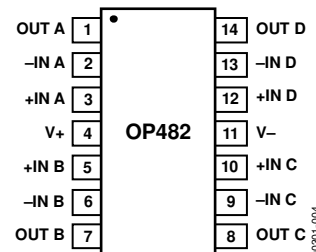

Figure 4. 14-Lead, Narrow-Body SOIC (S-Suffix) [R-14]

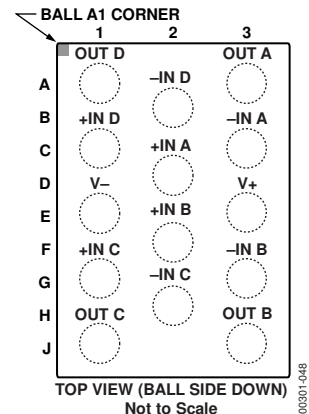

Figure 5. 14-Ball WLCSP [CB-14-2]

Rev. I

[Document Feedback](#)

Information furnished by Analog Devices is believed to be accurate and reliable. However, no responsibility is assumed by Analog Devices for its use, nor for any infringements of patents or other rights of third parties that may result from its use. Specifications subject to change without notice. No license is granted by implication or otherwise under any patent or patent rights of Analog Devices. Trademarks and registered trademarks are the property of their respective owners.

## TABLE OF CONTENTS

Features .....	1
Applications .....	1
General Description .....	1
Pin Connections .....	1
Revision History .....	2
Specifications .....	3
Electrical Characteristics .....	3
Absolute Maximum Ratings .....	4
Thermal Resistance .....	4

## REVISION HISTORY

### 9/13—Rev. H to Rev. I

Changes to Figure 5 .....	1
Updated Outline Dimensions .....	14
Changes to Ordering Guide .....	16

### 9/10—Rev. G to Rev. H

Added WLCSP .....	Universal
Changes to Features Section .....	1
Changes to General Description Section .....	1
Added Figure 5; Renumbered Sequentially .....	1
Changes to Large-Signal Voltage Gain Parameter, Table 1 .....	3
Changes to Table 2, Thermal Resistance Section, and Table 3 ...	4
Change to Figure 30 .....	9
Added Figure 53 .....	16
Changes to Ordering Guide .....	16

### 7/08—Rev. F to Rev. G

Changes to Phase Inversion Section .....	12
Deleted Figure 45 .....	12
Added Figure 45 and Figure 46 .....	12
Updated Outline Dimensions .....	14
Changes to Ordering Guide .....	16

### 10/04—Rev. E to Rev. F

Deleted 8-Lead PDIP .....	Universal
Added 8-Lead MSOP .....	Universal
Changes to Format and Layout .....	Universal
Changes to Features .....	1
Changes to Pin Configurations .....	1
Changes to General Description .....	1
Changes to Specifications .....	3
Changes to Absolute Maximum Ratings .....	4
Changes to Table 3 .....	4

ESD Caution .....	4
Typical Performance Characteristics .....	5
Applications Information .....	12
High-Side Signal Conditioning .....	12
Phase Inversion .....	12
Active Filters .....	12
Programmable State Variable Filter .....	13
Outline Dimensions .....	14
Ordering Guide .....	16

### Added Figure 5 through Figure 20; Renumbered

Successive Figures .....	5
Updated Figure 21 and Figure 22 .....	7
Updated Figure 23 and Figure 27 .....	8
Updated Figure 29 .....	9
Updated Figure 35 and Figure 36 .....	10
Updated Figure 43 .....	11
Changes to Applications Information .....	12
Changes to Figure 44 .....	12
Deleted OP282/OP482 Spice Macro Model Section .....	9
Deleted Figure 4 .....	9
Deleted OP282 Spice Marco Model .....	10
Updated Outline Dimensions .....	14
Changes to Ordering Guide .....	14

### 10/02—Rev. D to Rev. E

Edits to 8-Lead Epoxy DIP (P-Suffix) Pin .....	1
Edits to Ordering Guide .....	3
Edits to Outline Dimensions .....	11

### 9/02—Rev. C to Rev. D

Edits to 14-Lead SOIC (S-Suffix) Pin .....	1
Replaced 8-Lead SOIC (S-Suffix) .....	11

### 4/02—Rev. B to Rev. C

Wafer Test Limits Deleted .....	2
Edits to Absolute Maximum Ratings .....	3
Dice Characteristics Deleted .....	3
Edits to Ordering Guide .....	3
Edits to Figure 1 .....	7
Edits to Figure 3 .....	8
20-Position Chip Carrier (RC Suffix) Deleted .....	11

## SPECIFICATIONS

## ELECTRICAL CHARACTERISTICS

At  $V_S = \pm 15.0\text{ V}$ ,  $T_A = 25^\circ\text{C}$ , unless otherwise noted; applies to both A and G grades.

Table 1.

Parameter	Symbol	Test Conditions/Comments	Min	Typ	Max	Unit
INPUT CHARACTERISTICS						
Offset Voltage	$V_{OS}$	OP282		0.2	3	mV
		OP282, $-40^\circ\text{C} \leq T_A \leq +85^\circ\text{C}$			4.5	mV
Input Bias Current	$I_B$	OP482		0.2	4	mV
		OP482, $-40^\circ\text{C} \leq T_A \leq +85^\circ\text{C}$			6	mV
Input Offset Current	$I_{OS}$	$V_{CM} = 0\text{ V}$		3	100	pA
		$V_{CM} = 0\text{ V}^1$			500	pA
Input Voltage Range	CMRR	$V_{CM} = 0\text{ V}$		1	50	pA
		$V_{CM} = 0\text{ V}^1$			250	pA
Common-Mode Rejection Ratio		$-11\text{ V} \leq V_{CM} \leq +15\text{ V}$ , $-40^\circ\text{C} \leq T_A \leq +85^\circ\text{C}$	-11		+15	V
Large-Signal Voltage Gain	$A_{VO}$	$R_L = 10\text{ k}\Omega$ , $V_O = \pm 13.5\text{ V}$	70	90		dB
		$R_L = 10\text{ k}\Omega$ , $-40^\circ\text{C} \leq T_A \leq +85^\circ\text{C}$	20			V/mV
Offset Voltage Drift	$\Delta V_{OS}/\Delta T$			10		$\mu\text{V}/^\circ\text{C}$
Bias Current Drift	$\Delta I_B/\Delta T$			8		$\text{pA}/^\circ\text{C}$
OUTPUT CHARACTERISTICS						
Output Voltage High	$V_{OH}$	$R_L = 10\text{ k}\Omega$	13.5	13.9		V
Output Voltage Low	$V_{OL}$	$R_L = 10\text{ k}\Omega$		-13.9	-13.5	V
Short-Circuit Limit	$I_{SC}$	Source	3	10		mA
		Sink		-12	-8	mA
Open-Loop Output Impedance	$Z_{OUT}$	$f = 1\text{ MHz}$		200		$\Omega$
POWER SUPPLY						
Power Supply Rejection Ratio	PSRR	$V_S = \pm 4.5\text{ V}$ to $\pm 18\text{ V}$ , $-40^\circ\text{C} \leq T_A \leq +85^\circ\text{C}$		25	316	$\mu\text{V}/\text{V}$
Supply Current/Amplifier	$I_{SY}$	$V_O = 0\text{ V}$ , $-40^\circ\text{C} \leq T_A \leq 85^\circ\text{C}$		210	250	$\mu\text{A}$
Supply Voltage Range	$V_S$		$\pm 4.5$		$\pm 18$	V
DYNAMIC PERFORMANCE						
Slew Rate	SR	$R_L = 10\text{ k}\Omega$	7	9		$\text{V}/\mu\text{s}$
Full-Power Bandwidth	$BW_P$	1% distortion		125		kHz
Settling Time	$t_S$	To 0.01%		1.6		$\mu\text{s}$
Gain Bandwidth Product	GBP			4		MHz
Phase Margin	$\phi_M$			55		Degrees
NOISE PERFORMANCE						
Voltage Noise	$e_n$ p-p	0.1 Hz to 10 Hz		1.3		$\mu\text{V}$ p-p
Voltage Noise Density	$e_n$	$f = 1\text{ kHz}$		36		$\text{nV}/\sqrt{\text{Hz}}$
Current Noise Density	$i_n$			0.01		$\text{pA}/\sqrt{\text{Hz}}$

<sup>1</sup> The input bias and offset currents are characterized at  $T_A = T_J = 85^\circ\text{C}$ . Bias and offset currents are guaranteed but not tested at  $-40^\circ\text{C}$ .

## ABSOLUTE MAXIMUM RATINGS

Table 2.

Parameter	Rating
Supply Voltage	±18 V
Input Voltage	±18 V
Differential Input Voltage <sup>1</sup>	36 V
Output Short-Circuit Duration	Indefinite
Storage Temperature Range	−65°C to +150°C
Operating Temperature Range	−40°C to +85°C
Junction Temperature Range	−65°C to +150°C
Lead Temperature (Soldering 60 sec)	300°C

<sup>1</sup> For supply voltages less than ±18 V, the absolute maximum input voltage is equal to the supply voltage.

Stresses above those listed under Absolute Maximum Ratings may cause permanent damage to the device. This is a stress rating only; functional operation of the device at these or any other conditions above those indicated in the operational section of this specification is not implied. Exposure to absolute maximum rating conditions for extended periods may affect device reliability.

## THERMAL RESISTANCE

$\theta_{JA}$  is specified for the worst-case conditions, that is, a device in socket for PDIP.  $\theta_{JA}$  is specified for a device soldered in the circuit board for SOIC\_N, MSOP, and WLCSP packages. This was measured using a standard 4-layer board.

Table 3.

Package Type	$\theta_{JA}$	$\theta_{JC}$	Unit
8-Lead MSOP [RM]	142	45	°C/W
8-Lead SOIC_N (S-Suffix) [R]	120	45	°C/W
14-Lead PDIP (P-Suffix) [N]	83	39	°C/W
14-Lead SOIC_N (S-Suffix) [R]	112	35	°C/W
14-Ball WLCSP [CB] <sup>1,2</sup>	70	16	°C/W

<sup>1</sup> Simulated thermal numbers per JE5D51-9.

<sup>2</sup> Junction-to-board thermal resistance.

## ESD CAUTION



**ESD (electrostatic discharge) sensitive device.** Charged devices and circuit boards can discharge without detection. Although this product features patented or proprietary protection circuitry, damage may occur on devices subjected to high energy ESD. Therefore, proper ESD precautions should be taken to avoid performance degradation or loss of functionality.

TYPICAL PERFORMANCE CHARACTERISTICS

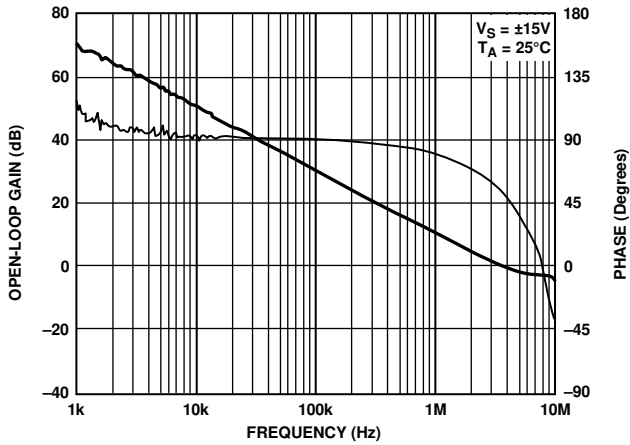

Figure 6. OP282 Open-Loop Gain and Phase vs. Frequency

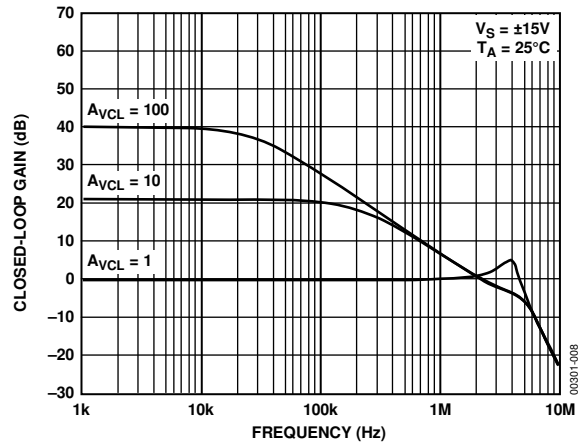

Figure 9. OP282 Closed-Loop Gain vs. Frequency

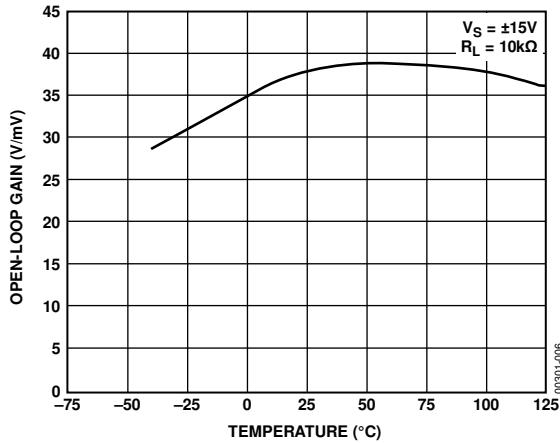

Figure 7. OP282 Open-Loop Gain vs. Temperature

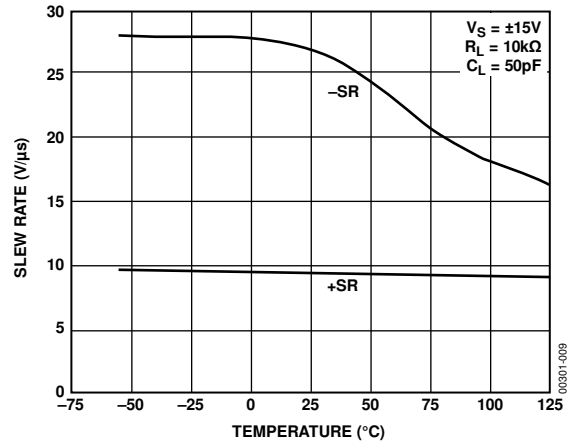

Figure 10. OP282 Slew Rate vs. Temperature

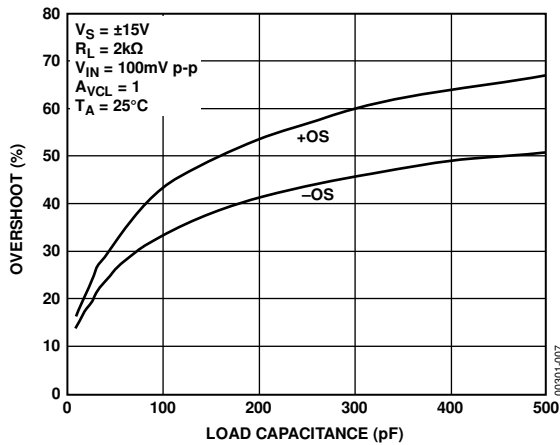

Figure 8. OP282 Small-Signal Overshoot vs. Load Capacitance

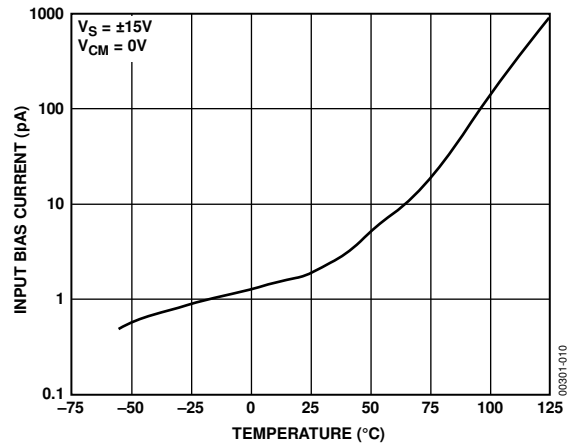

Figure 11. OP282 Input Bias Current vs. Temperature

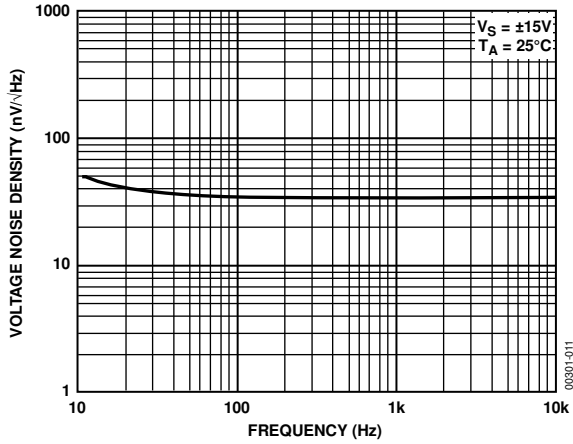

Figure 12. OP282 Voltage Noise Density vs. Frequency

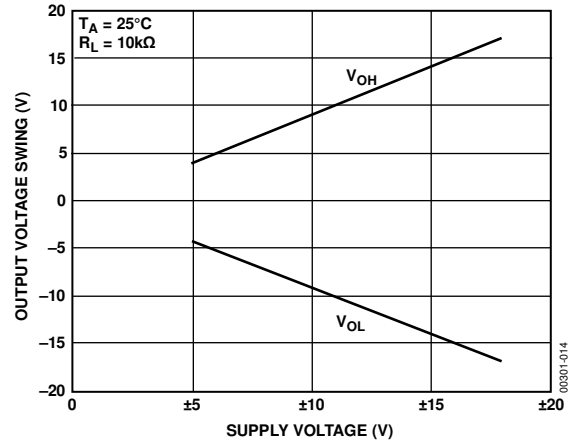

Figure 15. OP282 Output Voltage Swing vs. Supply Voltage

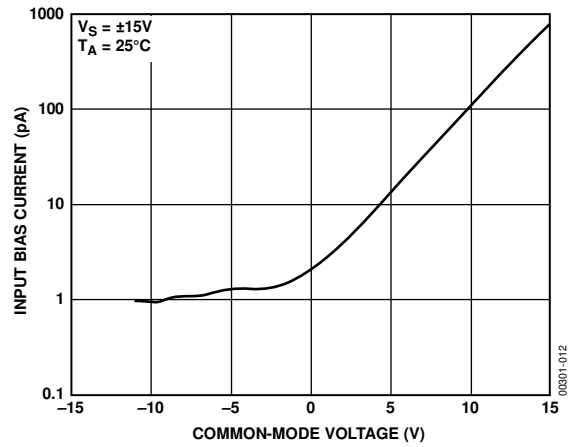

Figure 13. OP282 Input Bias Current vs. Common-Mode Voltage

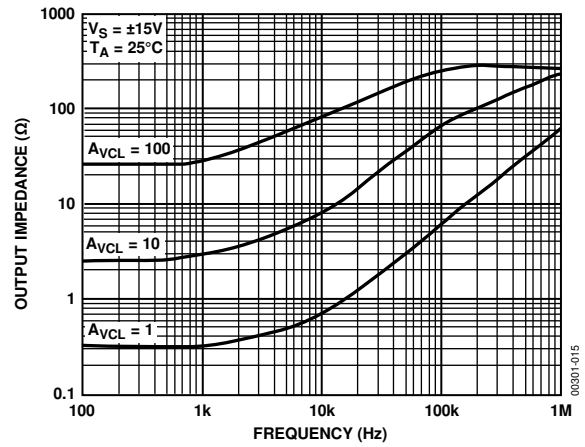

Figure 16. OP282 Closed-Loop Output Impedance vs. Frequency

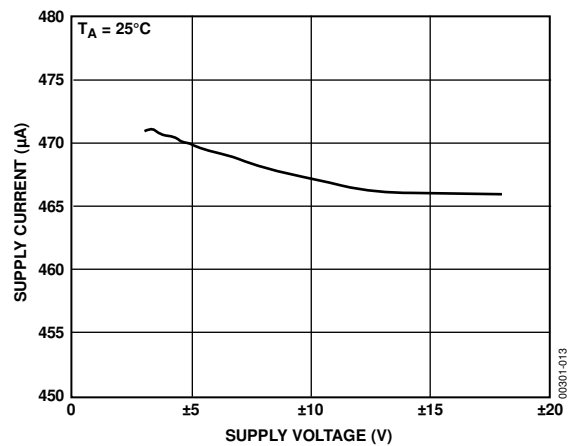

Figure 14. OP282 Supply Current vs. Supply Voltage

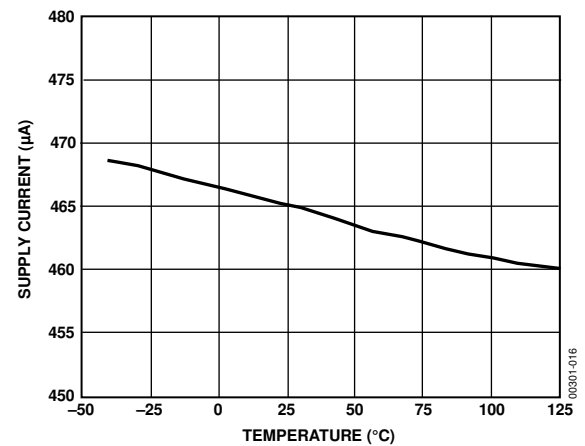

Figure 17. OP282 Supply Current vs. Temperature

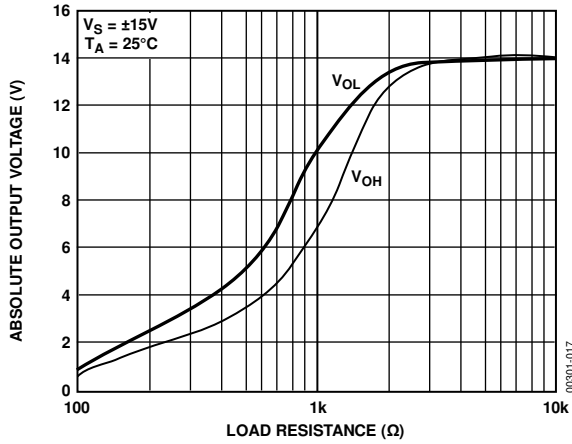

Figure 18. OP282 Absolute Output Voltage vs. Load Resistance

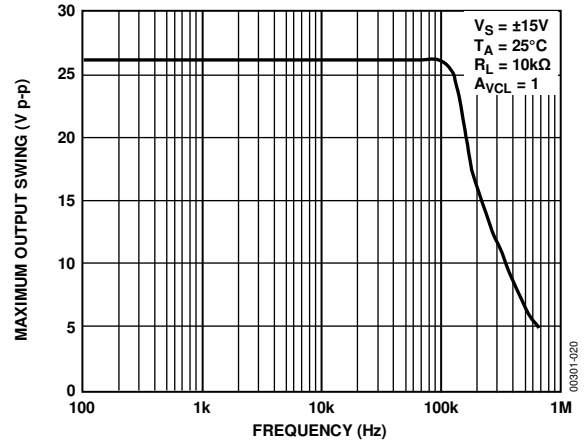

Figure 21. OP282 Maximum Output Swing vs. Frequency

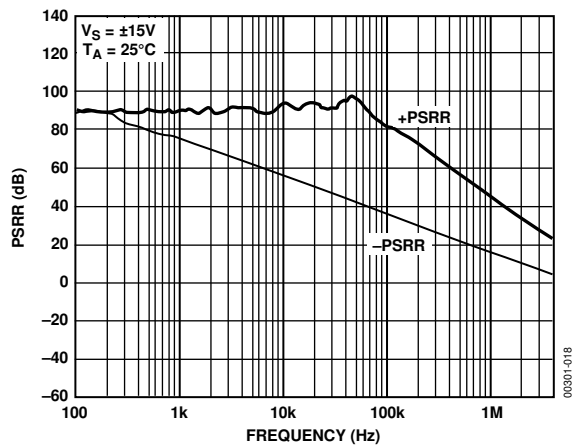

Figure 19. OP282 PSRR vs. Frequency

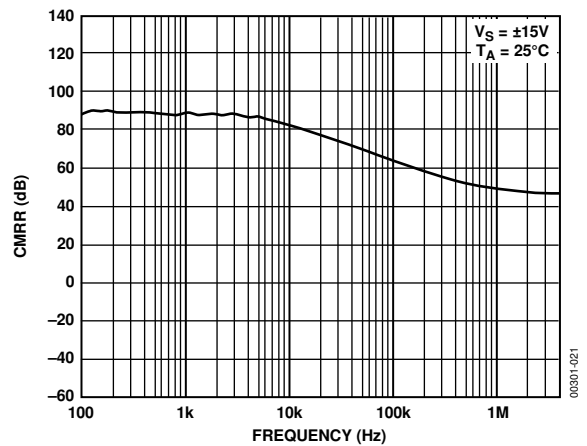

Figure 22. OP282 CMRR vs. Frequency

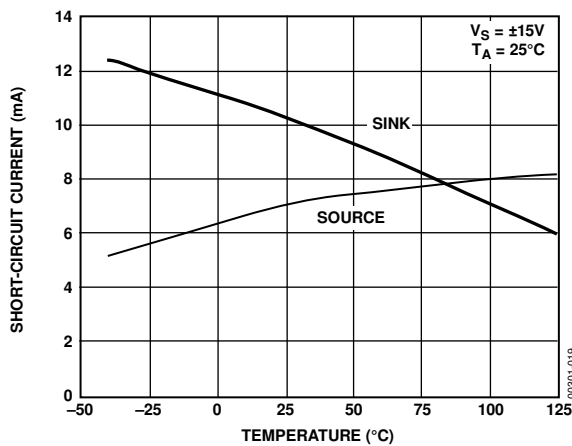

Figure 20. OP282 Short-Circuit Current vs. Temperature

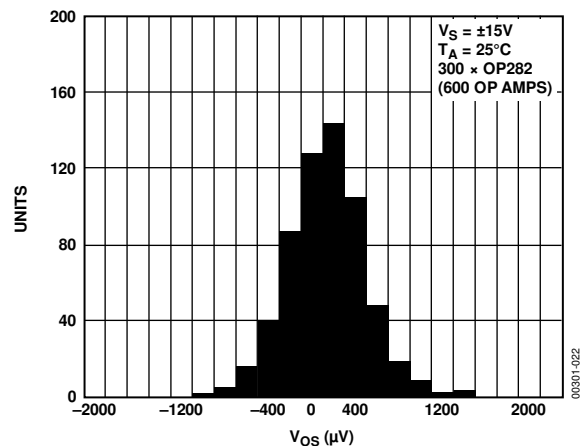

Figure 23. OP282  $V_{OS}$  Distribution, SOIC\_N Package

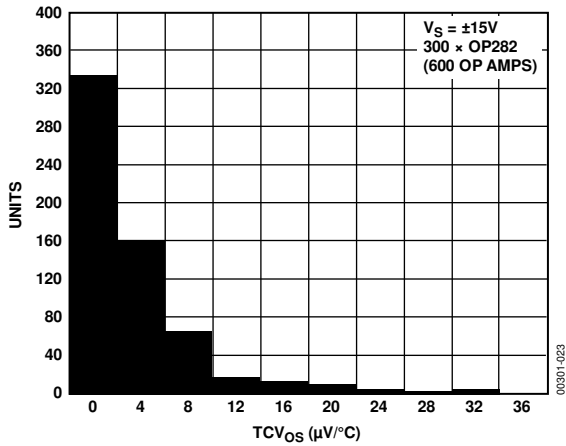

Figure 24. OP282 TCvos Distribution, SOIC\_N Package

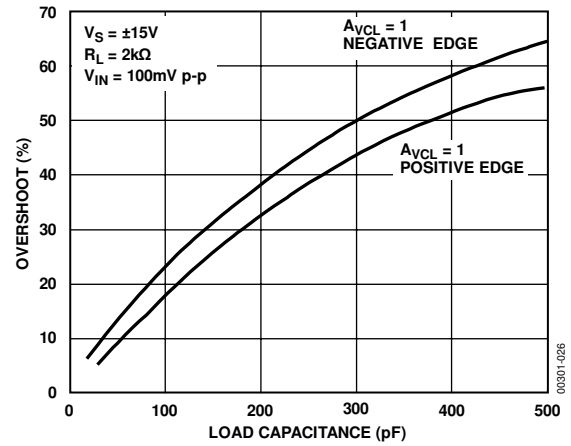

Figure 27. OP482 Small-Signal Overshoot vs. Load Capacitance

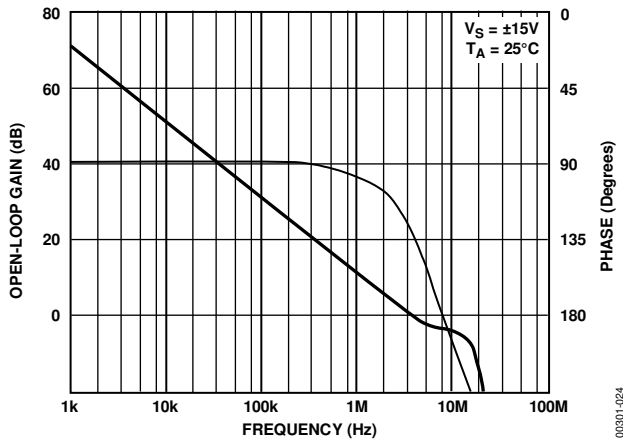

Figure 25. OP482 Open-Loop Gain and Phase vs. Frequency

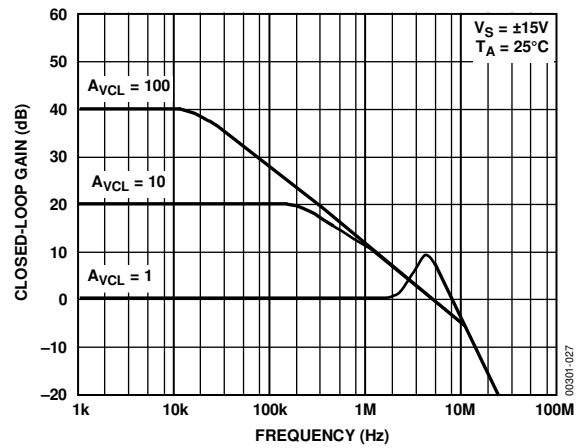

Figure 28. OP482 Closed-Loop Gain vs. Frequency

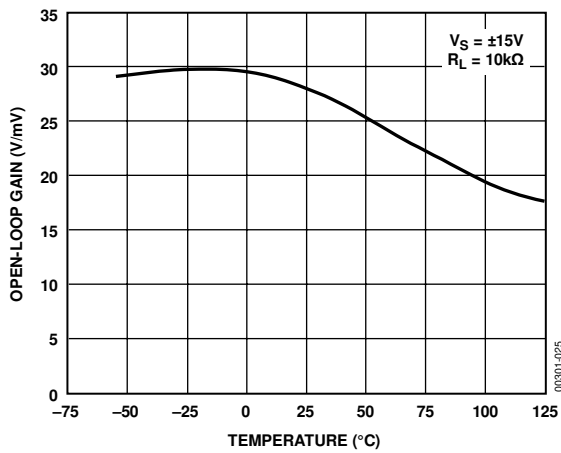

Figure 26. OP482 Open-Loop Gain vs. Temperature

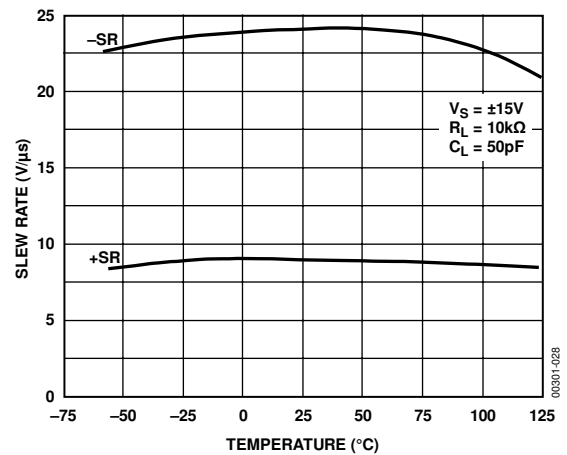

Figure 29. OP482 Slew Rate vs. Temperature

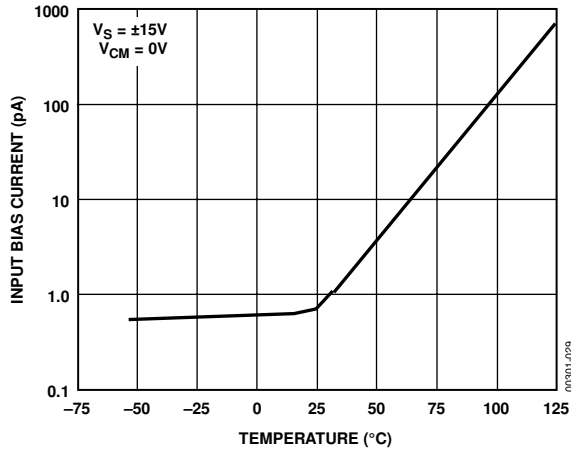

Figure 30. OP482 Input Bias Current vs. Temperature

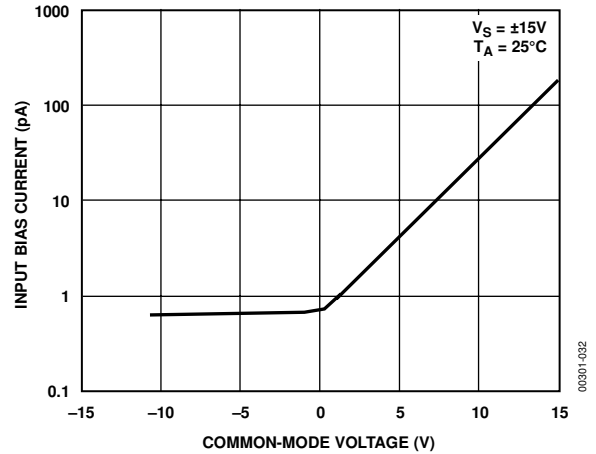

Figure 33. OP482 Input Bias Current vs. Common-Mode Voltage

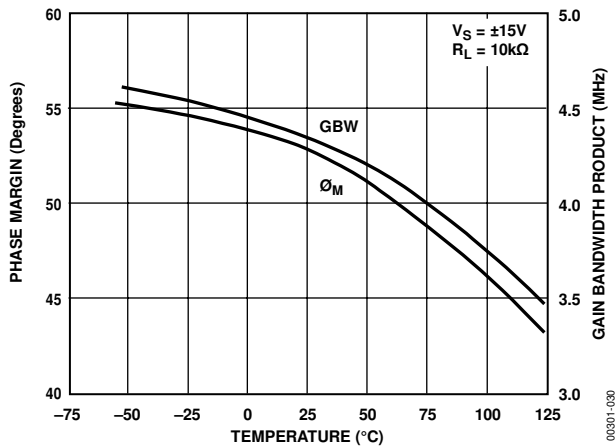

Figure 31. OP482 Phase Margin and Gain Bandwidth Product vs. Temperature

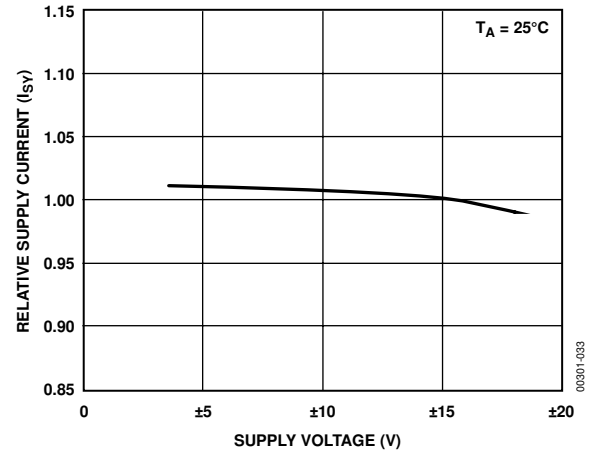

Figure 34. OP482 Relative Supply Current vs. Supply Voltage

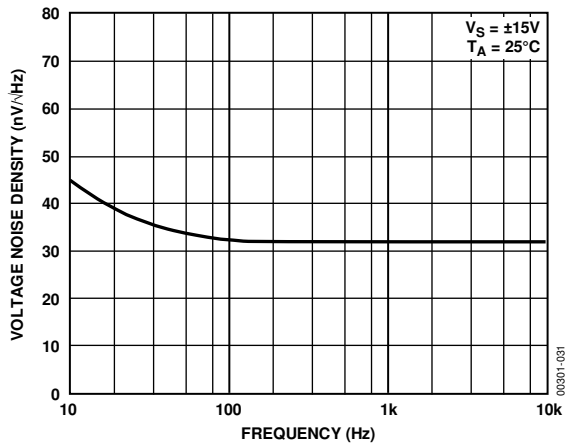

Figure 32. OP482 Voltage Noise Density vs. Frequency

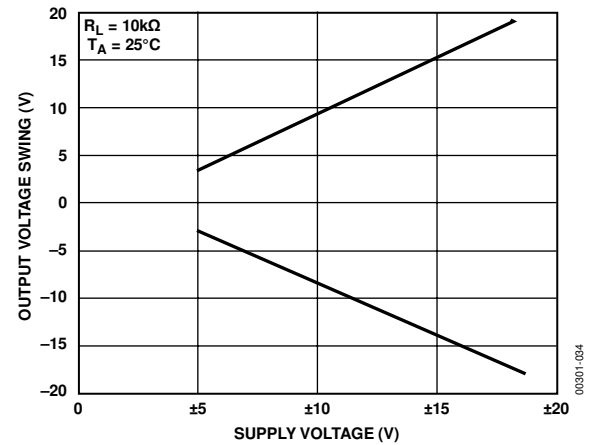

Figure 35. OP482 Output Voltage Swing vs. Supply Voltage

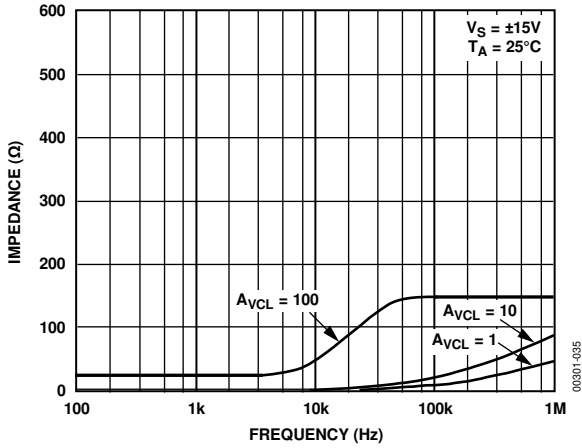

Figure 36. OP482 Closed-Loop Output Impedance vs. Frequency

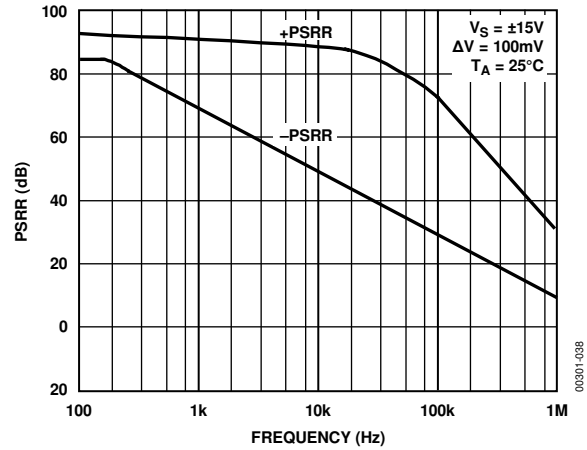

Figure 39. OP482 Power Supply Rejection Ratio (PSRR) vs. Frequency

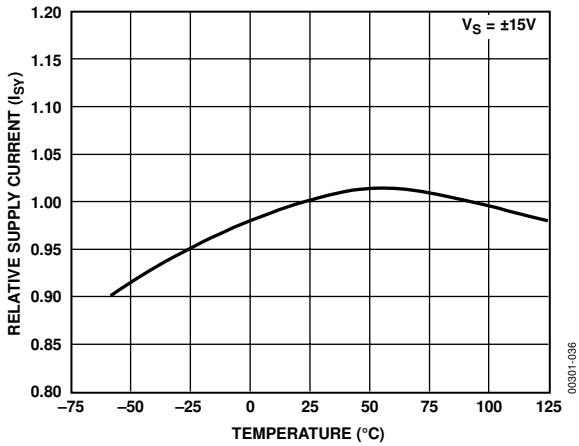

Figure 37. OP482 Relative Supply Current vs. Temperature

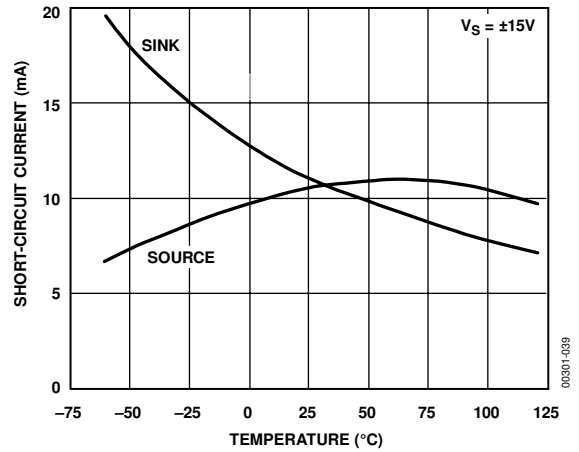

Figure 40. OP482 Short-Circuit Current vs. Temperature

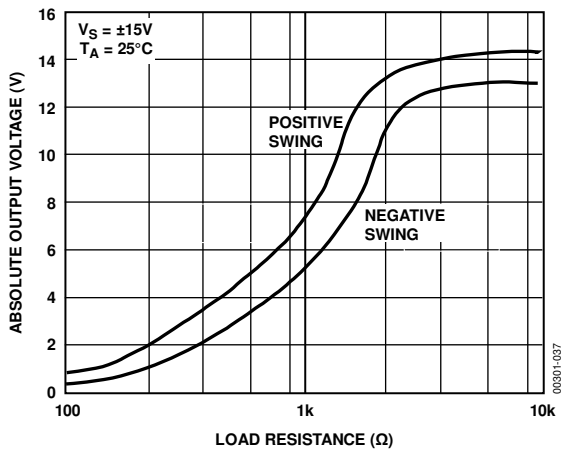

Figure 38. OP482 Maximum Output Voltage vs. Load Resistance

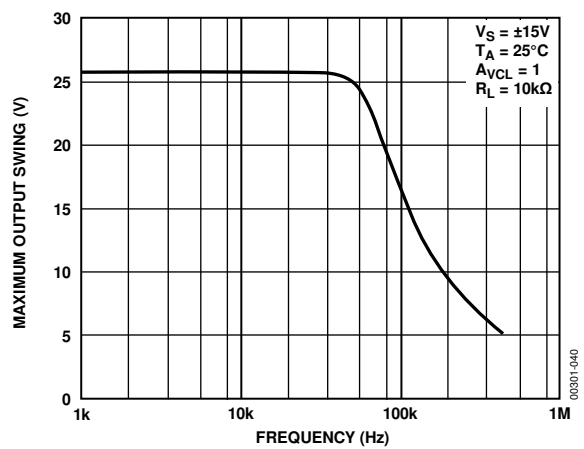

Figure 41. OP482 Maximum Output Swing vs. Frequency

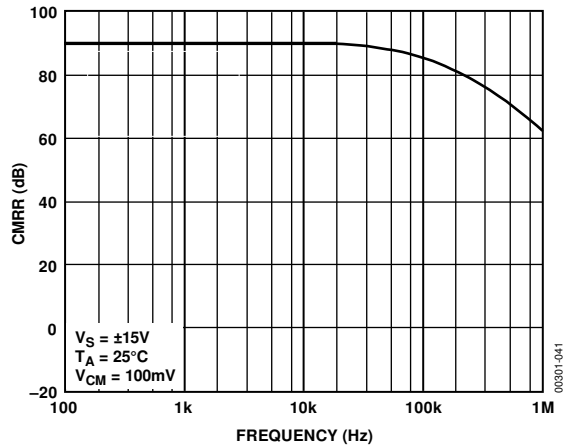

Figure 42. OP482 Common-Mode Rejection Ratio (CMRR) vs. Frequency

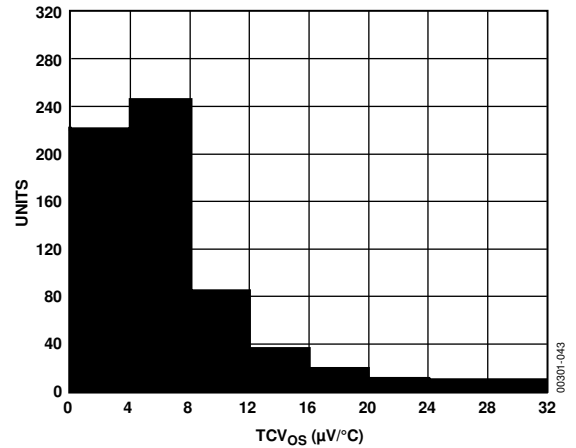

Figure 44. OP482 TCVOS Distribution, PDIP Package

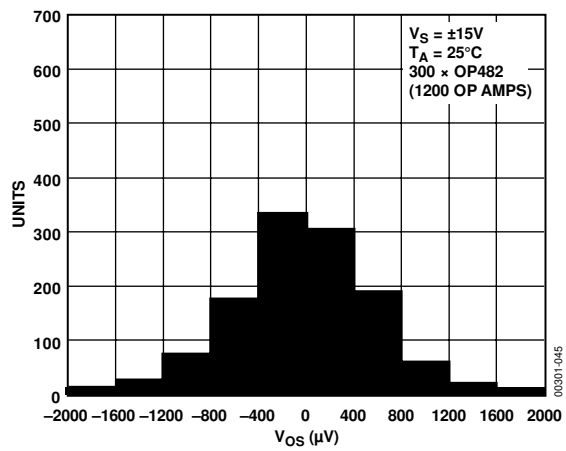

Figure 43. OP482 VOS Distribution, PDIP Package

### APPLICATIONS INFORMATION

The OP282 and OP482 are dual and quad JFET op amps that are optimized for high speed at low power. This combination makes these amplifiers excellent choices for battery-powered or low power applications that require above average performance. Applications benefiting from this performance combination include telecommunications, geophysical exploration, portable medical equipment, and navigational instrumentation.

### HIGH-SIDE SIGNAL CONDITIONING

Many applications require the sensing of signals near the positive rail. OP282 and OP482 were tested and are guaranteed over a common-mode range  $(-11\text{ V} \leq V_{CM} \leq +15\text{ V})$  that includes the positive supply.

One application where such sensing is commonly used is in the sensing of power supply currents. Therefore, the OP282/OP482 can be used in current sensing applications, such as the partial circuit shown in Figure 45. In this circuit, the voltage drop across a low value resistor, such as the  $0.1\ \Omega$  shown here, is amplified and compared to  $7.5\text{ V}$ . The output can then be used for current limiting.

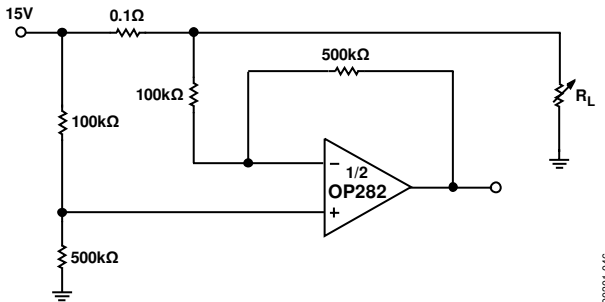

Figure 45. High-Side Signal Conditioning

### PHASE INVERSION

Most JFET input amplifiers invert the phase of the input signal if either input exceeds the input common-mode range. For the OP282/OP482, a negative signal in excess of  $11\text{ V}$  causes phase inversion. This is caused by saturation of the input stage, leading to the forward-biasing of a gate-drain diode. Phase reversal in the OP282/OP482 can be prevented by using Schottky diodes to clamp the input terminals to each other and to the supplies. In the simple buffer circuit shown in Figure 46, D1 protects the op

amp against phase reversal. R1, D2, and D3 limit the input current when the input exceeds the supply rail. The resistor should be selected to limit the amount of input current below the absolute maximum rating.

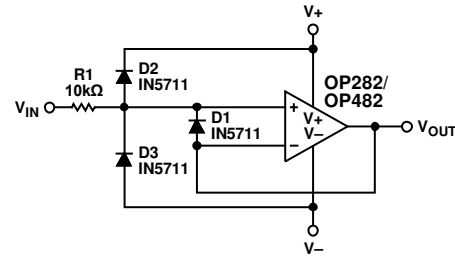

Figure 46. Phase Reversal Solution Circuit

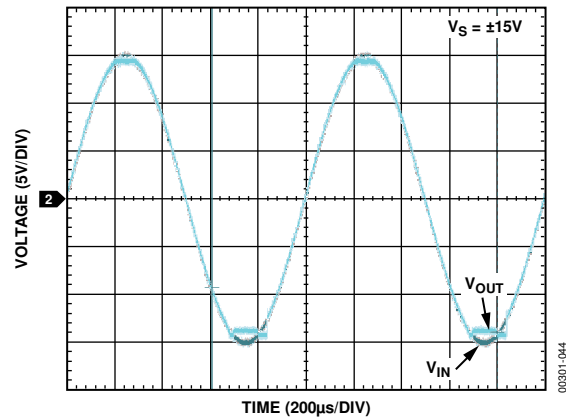

Figure 47. No Phase Reversal

### ACTIVE FILTERS

The wide bandwidth and high slew rates of the OP282/OP482 make either one an excellent choice for many filter applications.

There are many active filter configurations, but the four most popular configurations are Butterworth, elliptic, Bessel, and Chebyshev. Each type has a response that is optimized for a given characteristic, as shown in Table 4.

Table 4. Active Filter Configurations

Type	Selectivity	Overshoot	Phase	Amplitude (Pass Band)	Amplitude (Stop Band)
Butterworth	Moderate	Good	Nonlinear	Maximum flat	Equal ripple
Chebyshev	Good	Moderate		Equal ripple	
Elliptic	Best	Poor		Equal ripple	
Bessel (Thompson)	Poor	Best	Linear		



OUTLINE DIMENSIONS

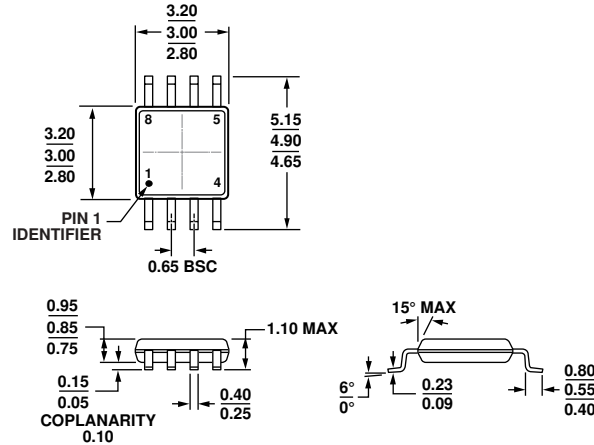

COMPLIANT TO JEDEC STANDARDS MO-187-AA

Figure 49. 8-Lead Mini Small Outline Package [MSOP] (RM-8)

Dimensions shown in millimeters

10-07-2009-B

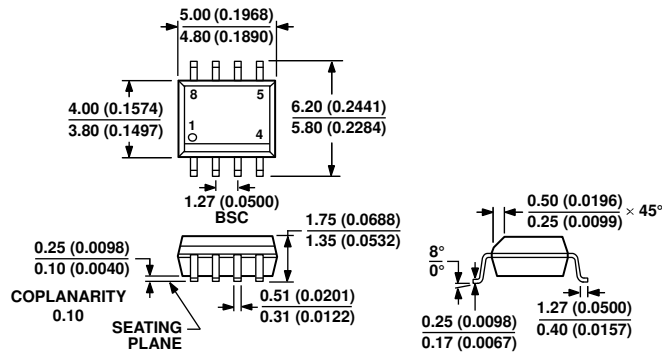

COMPLIANT TO JEDEC STANDARDS MS-012-AA

CONTROLLING DIMENSIONS ARE IN MILLIMETERS; INCH DIMENSIONS (IN PARENTHESES) ARE ROUNDED-OFF MILLIMETER EQUIVALENTS FOR REFERENCE ONLY AND ARE NOT APPROPRIATE FOR USE IN DESIGN.

Figure 50. 8-Lead Standard Small Outline Package [SOIC\_N] Narrow Body S-Suffix (R-8)

Dimensions shown in millimeters and (inches)

012407-A

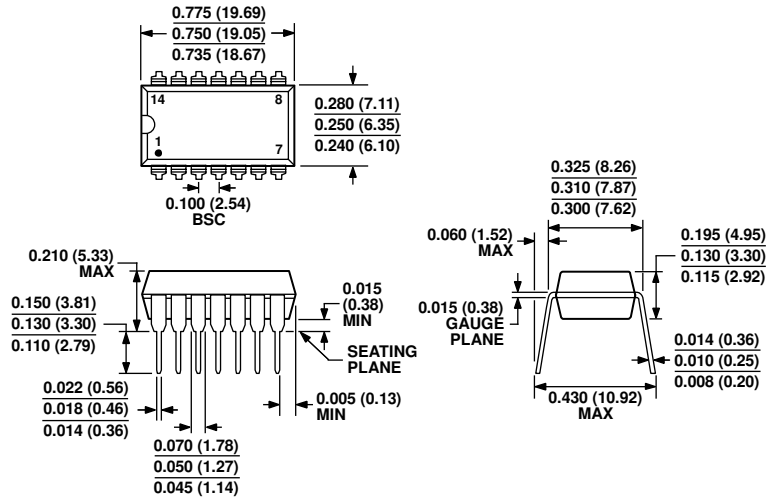

COMPLIANT TO JEDEC STANDARDS MS-001  
 CONTROLLING DIMENSIONS ARE IN INCHES; MILLIMETER DIMENSIONS  
 (IN PARENTHESES) ARE ROUNDED-OFF INCH EQUIVALENTS FOR  
 REFERENCE ONLY AND ARE NOT APPROPRIATE FOR USE IN DESIGN.  
 CORNER LEADS MAY BE CONFIGURED AS WHOLE OR HALF LEADS.

Figure 51. 14-Lead Plastic Dual In-Line Package [PDIP]  
 P-Suffix (N-14)

Dimension shown in inches and (millimeters)

071606-A

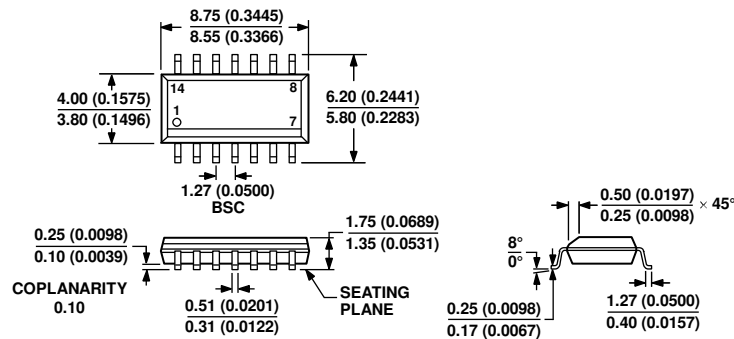

COMPLIANT TO JEDEC STANDARDS MS-012-AB  
 CONTROLLING DIMENSIONS ARE IN MILLIMETERS; INCH DIMENSIONS  
 (IN PARENTHESES) ARE ROUNDED-OFF MILLIMETER EQUIVALENTS FOR  
 REFERENCE ONLY AND ARE NOT APPROPRIATE FOR USE IN DESIGN.

Figure 52. 14-Lead Standard Small Outline Package [SOIC\_N]  
 Narrow Body  
 S-Suffix (R-14)

Dimensions shown in millimeters and (inches)

060106-A

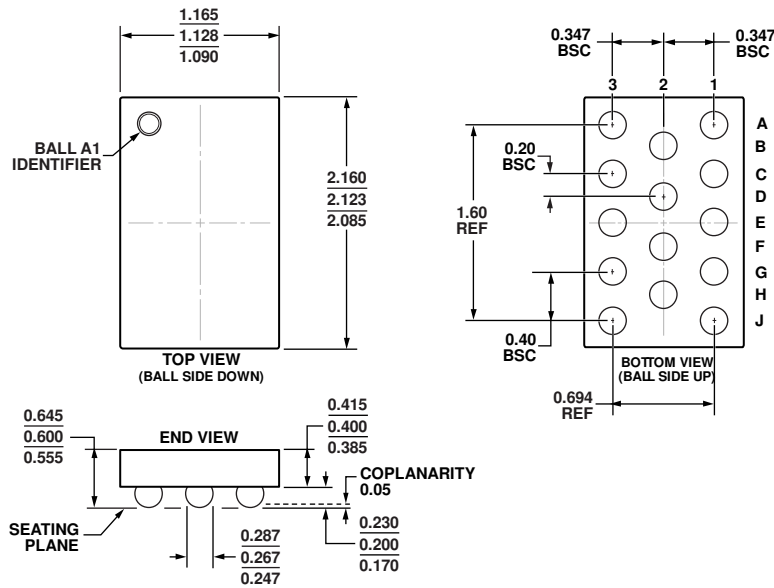

Figure 53. 14-Ball Wafer Level Chip Scale Package [WLCSP]  
CB-14-2  
Controlling dimensions are millimeters

**ORDERING GUIDE**

Model <sup>1</sup>	Temperature Range	Package Description	Package Option	Branding
OP282ARMZ	-40°C to +85°C	8-Lead MSOP	RM-8	A0B
OP282ARMZ-REEL	-40°C to +85°C	8-Lead MSOP	RM-8	A0B
OP282GS	-40°C to +85°C	8-Lead SOIC_N	S-Suffix (R-8)	
OP282GS-REEL	-40°C to +85°C	8-Lead SOIC_N	S-Suffix (R-8)	
OP282GS-REEL7	-40°C to +85°C	8-Lead SOIC_N	S-Suffix (R-8)	
OP282GSZ	-40°C to +85°C	8-Lead SOIC_N	S-Suffix (R-8)	
OP282GSZ-REEL	-40°C to +85°C	8-Lead SOIC_N	S-Suffix (R-8)	
OP282GSZ-REEL7	-40°C to +85°C	8-Lead SOIC_N	S-Suffix (R-8)	
OP482ACBZ-RL	-40°C to +85°C	14-Ball WLCSP	CB-14-2	A2J
OP482ACBZ-R7	-40°C to +85°C	14-Ball WLCSP	CB-14-2	A2J
OP482GPZ	-40°C to +85°C	14-Lead PDIP	P-Suffix (N-14)	
OP482GS	-40°C to +85°C	14-Lead SOIC_N	S-Suffix (R-14)	
OP482GS-REEL	-40°C to +85°C	14-Lead SOIC_N	S-Suffix (R-14)	
OP482GS-REEL7	-40°C to +85°C	14-Lead SOIC_N	S-Suffix (R-14)	
OP482GSZ	-40°C to +85°C	14-Lead SOIC_N	S-Suffix (R-14)	
OP482GSZ-REEL	-40°C to +85°C	14-Lead SOIC_N	S-Suffix (R-14)	
OP482GSZ-REEL7	-40°C to +85°C	14-Lead SOIC_N	S-Suffix (R-14)	

<sup>1</sup> Z = RoHS Compliant Part.