



Chipsmall Limited consists of a professional team with an average of over 10 year of expertise in the distribution of electronic components. Based in Hongkong, we have already established firm and mutual-benefit business relationships with customers from,Europe,America and south Asia,supplying obsolete and hard-to-find components to meet their specific needs.

With the principle of "Quality Parts,Customers Priority,Honest Operation,and Considerate Service",our business mainly focus on the distribution of electronic components. Line cards we deal with include Microchip,ALPS,ROHM,Xilinx,Pulse,ON,Everlight and Freescale. Main products comprise IC,Modules,Potentiometer,IC Socket,Relay,Connector.Our parts cover such applications as commercial,industrial, and automotives areas.

We are looking forward to setting up business relationship with you and hope to provide you with the best service and solution. Let us make a better world for our industry!



Contact us

Tel: +86-755-8981 8866 Fax: +86-755-8427 6832

Email & Skype: info@chipsmall.com Web: www.chipsmall.com

Address: A1208, Overseas Decoration Building, #122 Zhenhua RD., Futian, Shenzhen, China



NPN Plastic Silicon Phototransistor

OP593, OP598, OP793, OP798 Series



Features:

- Dark blue epoxy package
- Wide receiving angle
- Variety of sensitivity ranges
- TO-18 equivalent package style

Description:

Each device in this series consists of an NPN silicon phototransistor molded in a dark blue epoxy packages. The wide receiving angle (130°) of the **OP593** and **OP793** series devices provides relatively even reception over a large area. The narrow receiving angle (25°) of the **OP598** and **OP798** series devices provides a relatively small reception area.

These devices are 100% production tested using infrared light for close correlation with OPTEK's GaAs and GaAlAs emitters.

Please refer to Application Bulletins 208 and 210 for additional design information and reliability (degradation) data.

Applications:

- Non-contact reflective or slotted sensor
- Assembly line automation
- Machine automation
- Machine Safety
- End of travel sensor
- Door sensor
- Safety Curtain



Pin #	Sensor
1	Collector
2	Emitter

Ordering Information			
Part Number	Sensor	Viewing Angle	Lead Length
OP593A	Transistor	130°	0.75"
OP593B			
OP593C			
OP598A			
OP598B	25°		
OP598C			
OP793A	R _{BE} Transistor	130°	
OP793B			
OP793C			
OP793D			
OP798A	25°		
OP798B			
OP798C			
OP798D			

OP593, OP793

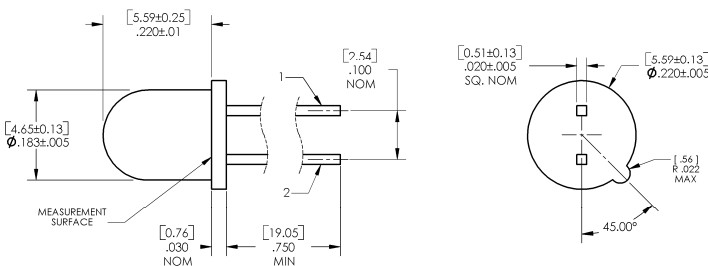

OP598, OP798

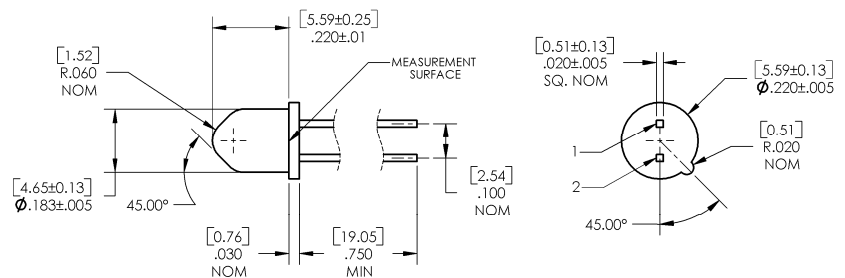

OP555 - CONTAINS POLYSULFONE
 To avoid stress cracking, we suggest using ND Industries' **Vibra-Tite** for thread-locking. **Vibra-Tite** evaporates fast without causing structural failure in OPTEK's molded plastics.



DIMENSIONS ARE IN: [MILLIMETERS]
[INCHES]

General Note
 TT Electronics reserves the right to make changes in product specification without notice or liability. All information is subject to TT Electronics' own data and is considered accurate at time of going to print.

OPTEK Technology, Inc.
 1645 Wallace Drive, Carrollton, TX 75006 | Ph: +1 972 323 2200
 www.optekinc.com | www.ttelectronics.com

NPN Plastic Silicon Phototransistor

OP593, OP598, OP793, OP798 Series



Electrical Specifications

Absolute Maximum Ratings ($T_A = 25^\circ\text{C}$ unless otherwise noted)	
Storage and Operating Temperature Range	-40°C to $+100^\circ\text{C}$
Collector-Emitter Voltage	30 V
Emitter-Collector Voltage	5 V
Continuous Collector Current	50 mA
Lead Soldering Temperature [1/16 inch (1.6 mm) from case for 5 seconds with soldering iron]	$260^\circ\text{C}^{(1)}$
Power Dissipation	$250\text{ mW}^{(2)}$

Electrical Characteristics ($T_A = 25^\circ\text{C}$ unless otherwise noted)						
SYMBOL	PARAMETER	MIN	TYP	MAX	UNITS	TEST CONDITIONS
$I_{C(ON)}$	On-State Collector Current					$V_{CE} = 5\text{ V}$. Light source is an unfiltered GaAlAs LED with a peak emission wavelength of 890 nm and $E_{e(APT)}$ of 1.7 mW/cm^2 average within a .250" diameter aperture.
	OP593A	3.0	-	4	mA	
	OP593B	2.0	-	4		
	OP593C	1.0	-	4		
	OP598A	7.5	-	10		
	OP598B	5.0	-	10		
	OP598C	2.5	-	10		
	OP598C	2.45	-	10		
	OP793A		-	7.50		
	OP793B	1.65	-	4.55		
	OP793C	0.90	-	3.05		
	OP793D	0.90	-	7.50		
	OP798A	4.90	-	15.00		
	OP798B	3.30	-	9.20		
OP798C	1.90	-	6.10			
OP798D	1.90	-	15.00			
I_{CEO}	Collector-Dark Current	-	-	100	nA	$V_{CE} = 10\text{ V}$, $E_E = 0$
$V_{(BR)CEO}$	Collector-Emitter Breakdown Voltage	30	-	-	V	$I_C = 100\ \mu\text{A}$
$V_{(BR)ECO}$	Emitter-Collector Breakdown Voltage	5	-	-	V	$I_E = 100\ \mu\text{A}$
$V_{CE(SAT)}$	Collector-Emitter Saturation Voltage	-	-	0.40	V	$I_C = 0.4\text{ mA}$, $E_E = 1.7\text{ mW/cm}^2$

General Note
 TT Electronics reserves the right to make changes in product specification without notice or liability. All information is subject to TT Electronics' own data and is considered accurate at time of going to print.

NPN Plastic Silicon Phototransistor

OP593, OP598, OP793, OP798 Series



Performance

OP593, OP598

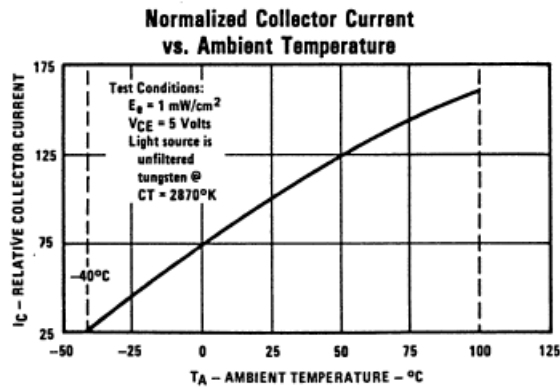
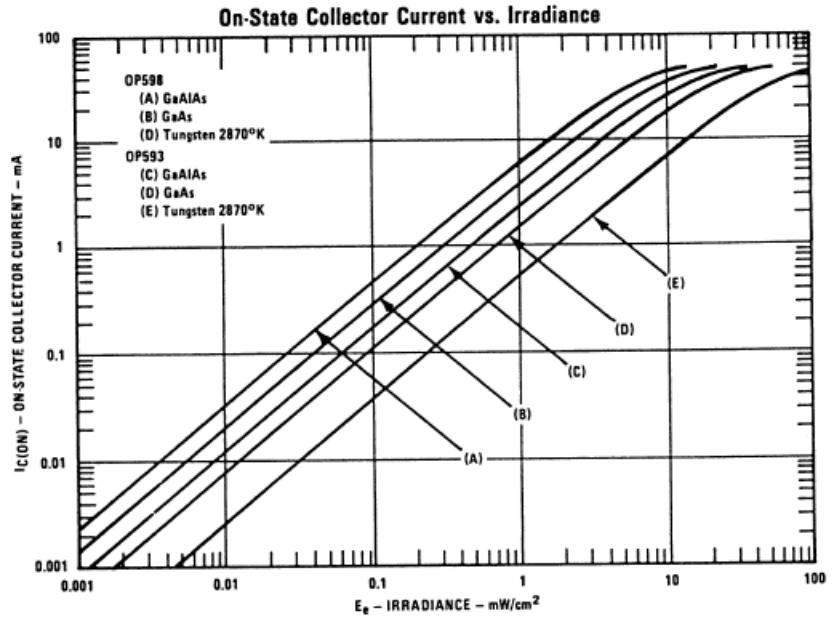
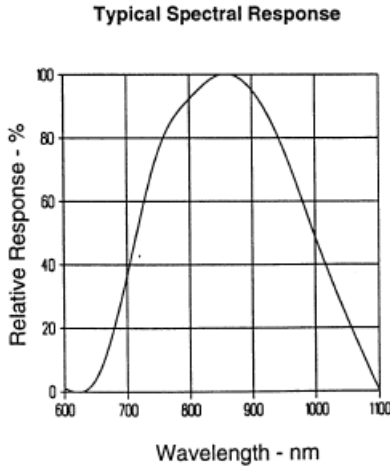

General Note
 TT Electronics reserves the right to make changes in product specification without notice or liability. All information is subject to TT Electronics' own data and is considered accurate at time of going to print.

OPTEK Technology, Inc.
 1645 Wallace Drive, Carrollton, TX 75006 | Ph: +1 972 323 2200
www.optekinc.com | www.ttelectronics.com

NPN Plastic Silicon Phototransistor

OP593, OP598, OP793, OP798 Series



Performance

OP593, OP598

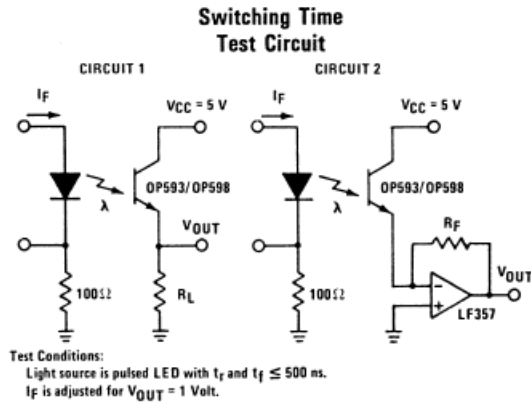
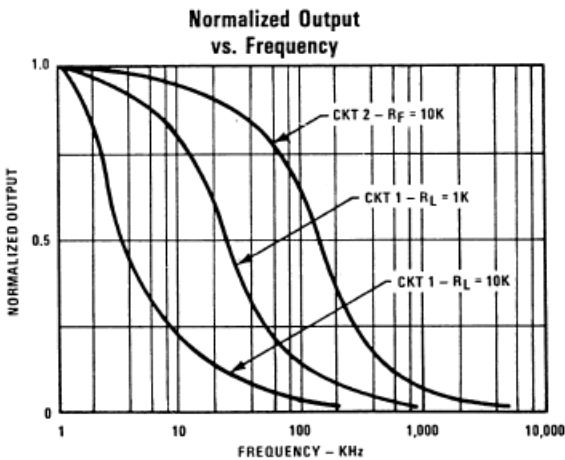
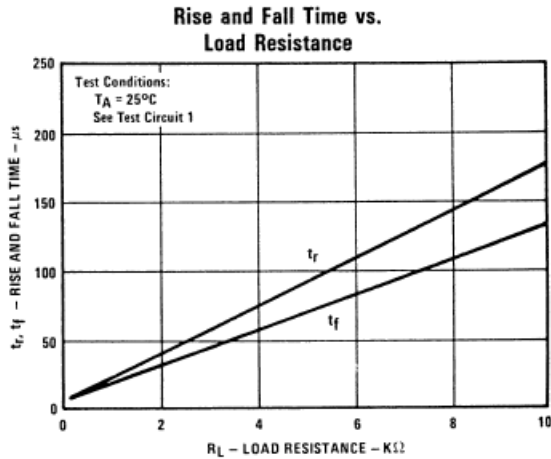
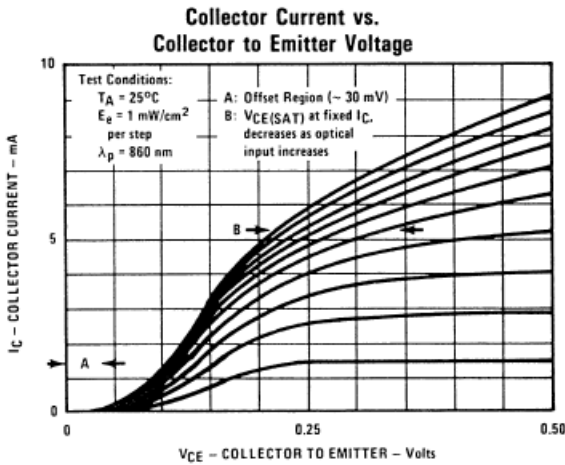
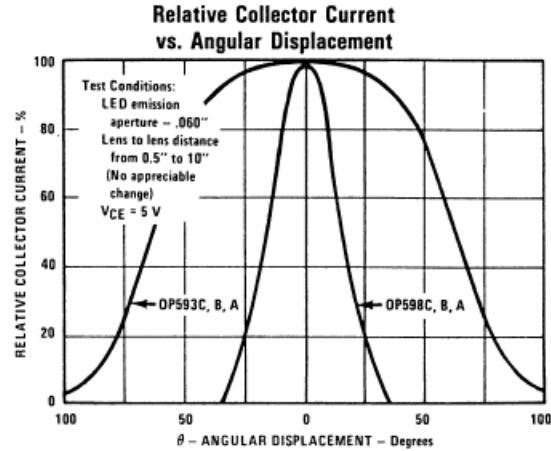
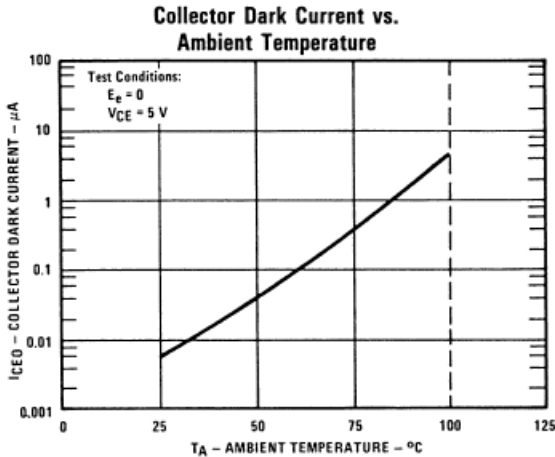

General Note
 TT Electronics reserves the right to make changes in product specification without notice or liability. All information is subject to TT Electronics' own data and is considered accurate at time of going to print.

OPTEK Technology, Inc.
 1645 Wallace Drive, Carrollton, TX 75006 | Ph: +1 972 323 2200
 www.optekinc.com | www.ttelectronics.com

NPN Plastic Silicon Phototransistor

OP593, OP598, OP793, OP798 Series



Performance

OP593, OP598
Spectral Response of OP593/OP598 vs. Tungsten

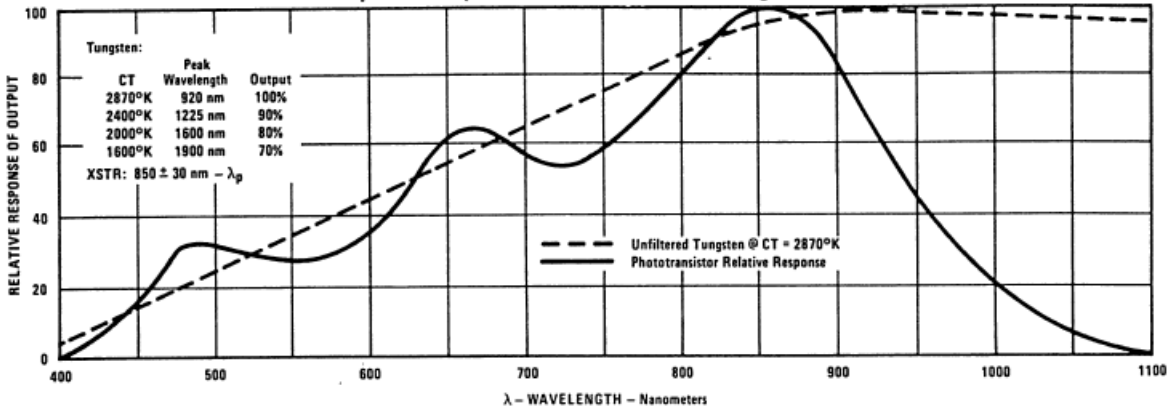

Spectral Response of OP593/OP598 vs. GaAlAs and GaAs

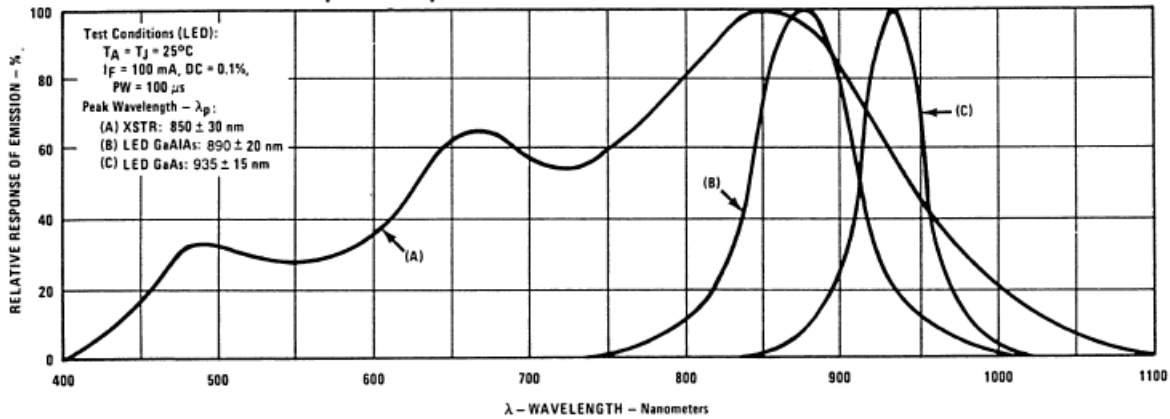

Coupling Characteristics of OP293/OP593 and OP298/OP598

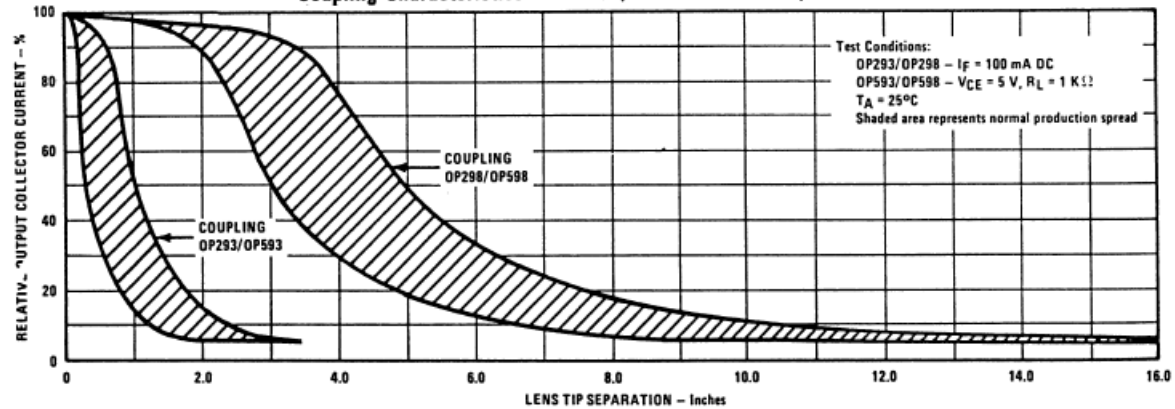

General Note
 TT Electronics reserves the right to make changes in product specification without notice or liability. All information is subject to TT Electronics' own data and is considered accurate at time of going to print.

OPTEK Technology, Inc.
 1645 Wallace Drive, Carrollton, TX 75006
 Ph: +1 972 323 2200
 www.optekinc.com | www.ttelectronics.com

NPN Plastic Silicon Phototransistor

OP593, OP598, OP793, OP798 Series



Performance

OP793, OP798

Typical Spectral Response

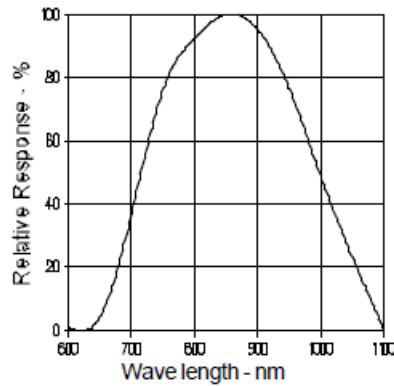

Schematic

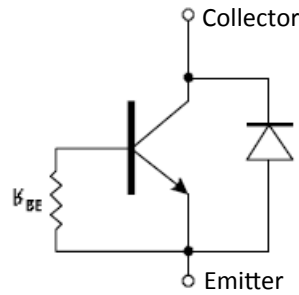

On-State Collector Current vs. Irradiance

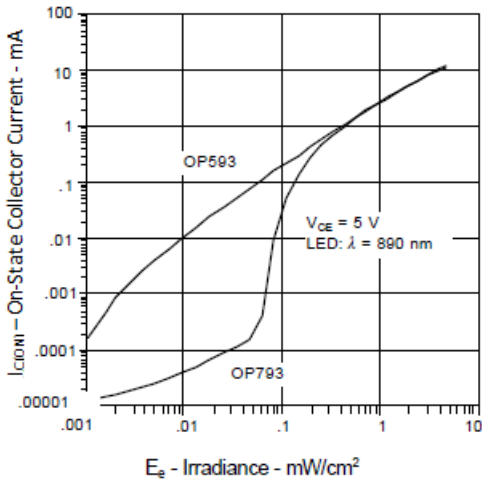

On-State Collector Current vs. Irradiance

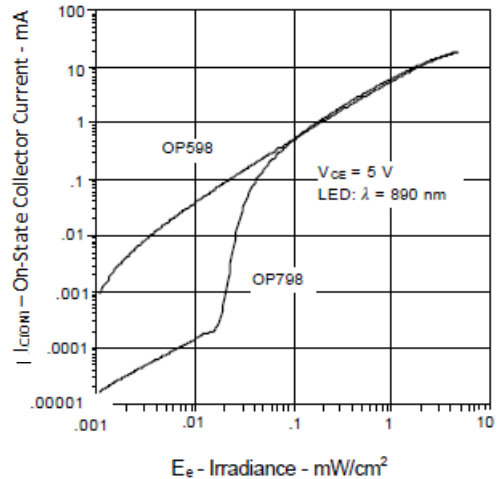

NPN Plastic Silicon Phototransistor

OP593, OP598, OP793, OP798 Series



Performance

OP793, OP798

Normalized Output vs. Frequency

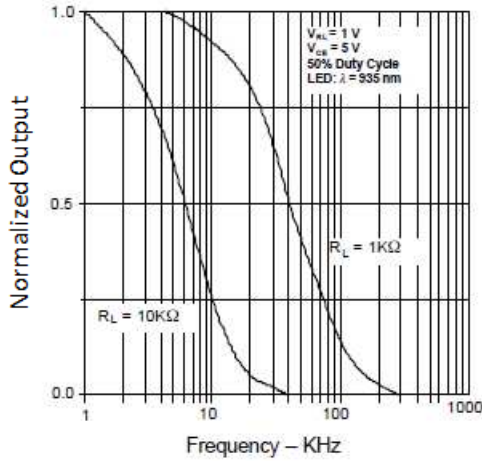

Typical Rise and Fall Time vs. Load Resistance

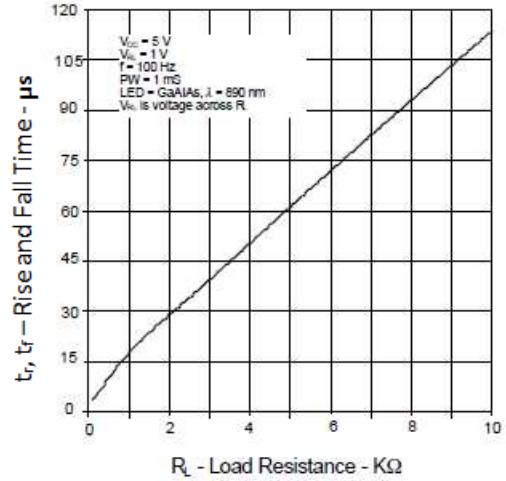

Normalized Light and Dark Current vs. Ambient Temperature

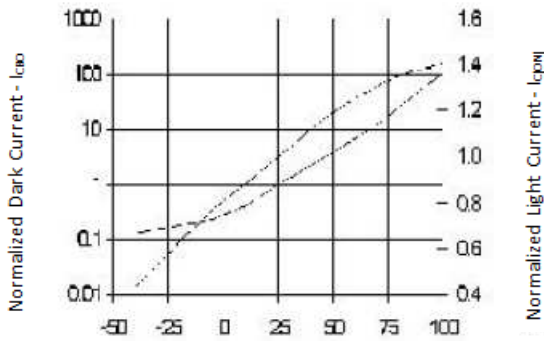

General Note
TT Electronics reserves the right to make changes in product specification without notice or liability. All information is subject to TT Electronics' own data and is considered accurate at time of going to print.

OPTEK Technology, Inc.
1645 Wallace Drive, Carrollton, TX 75006 | Ph: +1 972 323 2200
www.optekinc.com | www.ttelectronics.com