



Chipsmall Limited consists of a professional team with an average of over 10 year of expertise in the distribution of electronic components. Based in Hongkong, we have already established firm and mutual-benefit business relationships with customers from,Europe,America and south Asia,supplying obsolete and hard-to-find components to meet their specific needs.

With the principle of "Quality Parts,Customers Priority,Honest Operation,and Considerate Service",our business mainly focus on the distribution of electronic components. Line cards we deal with include Microchip,ALPS,ROHM,Xilinx,Pulse,ON,Everlight and Freescale. Main products comprise IC,Modules,Potentiometer,IC Socket,Relay,Connector.Our parts cover such applications as commercial,industrial, and automotives areas.

We are looking forward to setting up business relationship with you and hope to provide you with the best service and solution. Let us make a better world for our industry!



## Contact us

Tel: +86-755-8981 8866 Fax: +86-755-8427 6832

Email & Skype: info@chipsmall.com Web: www.chipsmall.com

Address: A1208, Overseas Decoration Building, #122 Zhenhua RD., Futian, Shenzhen, China



# PIN Silicon Photodiode

OP993, OP999



## Features:

- Choice of TO-18 (OP993) or T-1¾ package (OP999)
- Small package style ideal for space-limited applications
- Linear response vs. irradiance
- Fast switching time
- Choice of narrow or wide receiving angle

## Description:

Each **OP993** and **OP999** device consists of a PIN silicon photodiode molded in a dark blue injection molded shell package that provides excellent optical and mechanical axis alignment, optical lens surface, control of chip placement and consistency of the outside package dimensions.

**OP993** has a TO-18 package style and a *wide* receiving angle that provides excellent on-axis coupling. **OP999** has a T-1¾ package style and a *narrow* receiving angle that provides excellent on-axis coupling.

Both devices are 100% production tested for close correlation with OPTEK GaAIAs emitters.

*Please refer to Application Bulletins 208 and 210 for additional design information and reliability (degradation) data.*

## Applications:

- Non-contact reflective object sensor
- Assembly line automation
- Machine automation
- Machine safety
- End of travel sensor
- Door sensor

Ordering Information			
Part Number	Sensor	Viewing Angle	Lead Length
OP993	Photodiode	118°	0.75 min
OP999	Photodiode	18°	

OP993



Pin #	Sensor
1	Cathode
2	Anode

OP993

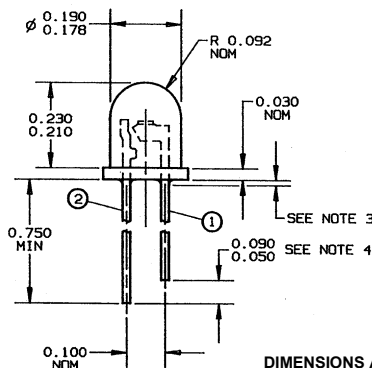

OP999

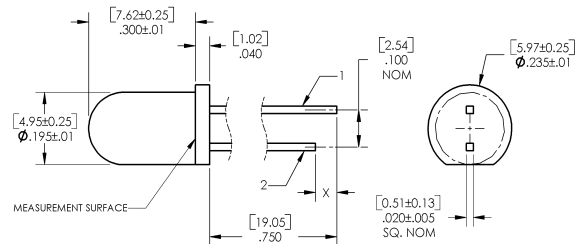

OP999

DIMENSIONS ARE IN: [MILLIMETERS] INCHES



Pin #	Sensor
1	Anode
2	Cathode

### CONTAINS POLYSULFONE

To avoid stress cracking, we suggest using ND Industries' **Vibra-Tite** for thread-locking. **Vibra-Tite** evaporates fast without causing structural failure in OPTEK'S molded plastics.



General Note  
TT Electronics reserves the right to make changes in product specification without notice or liability. All information is subject to TT Electronics' own data and is considered accurate at time of going to print.

OPTEK Technology, Inc.  
1645 Wallace Drive, Carrollton, TX 75006 | Ph: +1 972 323 2200  
www.optekinc.com | www.ttelectronics.com

# PIN Silicon Photodiode

OP993, OP999



## Electrical Specifications

Absolute Maximum Ratings ( $T_A = 25^\circ\text{C}$ unless otherwise noted)	
Reverse Breakdown Voltage	60 V
Storage & Operating Temperature Range	$-40^\circ\text{C}$ to $+100^\circ\text{C}$
Lead Soldering Temperature [1/16 inch (1.6 mm) from the case for 5 sec. with soldering iron]	$260^\circ\text{C}^{(1)}$
Reverse Breakdown Voltage	60 V
Power Dissipation	$100\text{ mW}^{(2)}$

Electrical Characteristics ( $T_A = 25^\circ\text{C}$ unless otherwise noted)						
SYMBOL	PARAMETER	MIN	TYP	MAX	UNITS	TEST CONDITIONS
$I_L$	Reverse Light Current					
	OP993	12.5	-	28.5	$\mu\text{A}$	$V_R = 5\text{ V}, E_E = 1.7\text{ mW/cm}^2^{(3)}$
	OP999	6.5	-	15		$V_R = 5\text{ V}, E_E = 0.25\text{ mW/cm}^2^{(3)}$
$I_D$	Reverse Dark Current		1	60	nA	$V_R = 30\text{ V}, E_E = 0^{(4)}$
$V_{(BR)}$	Reverse Breakdown Voltage	60			V	$I_R = 100\ \mu\text{A}$
$V_F$	Forward Voltage			1.2	V	$I_F = 1\text{ mA}$
$C_T$	Total Capacitance		4		pF	$V_R = 20\text{ V}, E_E = 0, f = 1.0\text{ MHz}$
$t_r$	Rise Time		5		ns	$V_R = 20\text{ V}, \lambda = 850\text{ nm}, R_L = 50\ \Omega$
$t_f$	Fall Time		5			

### Notes:

- (1) RMA flux is recommended. Duration can be extended to 10 seconds maximum when flow soldering. A maximum of 20 grams force may be applied to leads when soldering.
- (2) Derate linearly  $1.67\text{ mW}/^\circ\text{C}$  above  $25^\circ\text{C}$ .
- (3) Light source is an unfiltered GaAlAs emitting diode operating at peak emission wavelength of 890 nm and  $E_{E(APT)}$  of  $1.7\text{ mW/cm}^2$  for OP993 and  $0.25\text{ mW/cm}^2$  for OP999 average within a 0.25" diameter aperture.
- (4) This dimension is held to within  $\pm 0.005''$  on the flange edge and may vary up to  $\pm 0.020''$  in the area of the leads.

### General Note

TT Electronics reserves the right to make changes in product specification without notice or liability. All information is subject to TT Electronics' own data and is considered accurate at time of going to print.

OPTEK Technology, Inc.  
1645 Wallace Drive, Carrollton, TX 75006 | Ph: +1 972 323 2200  
www.optekinc.com | www.ttelectronics.com

# PIN Silicon Photodiode

OP993, OP999



## OP993

### Coupling Characteristics OP993 and OP293

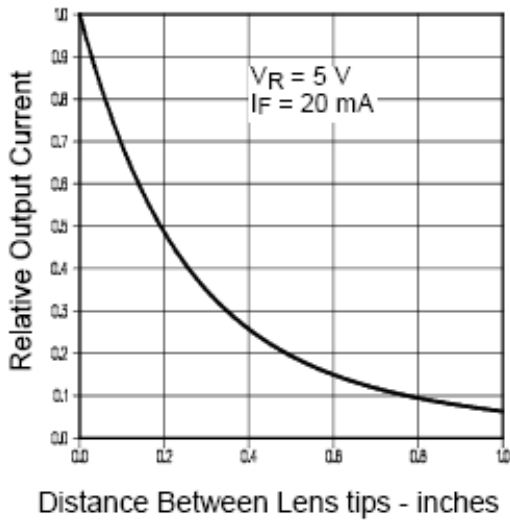

### Light Current vs. Irradiance

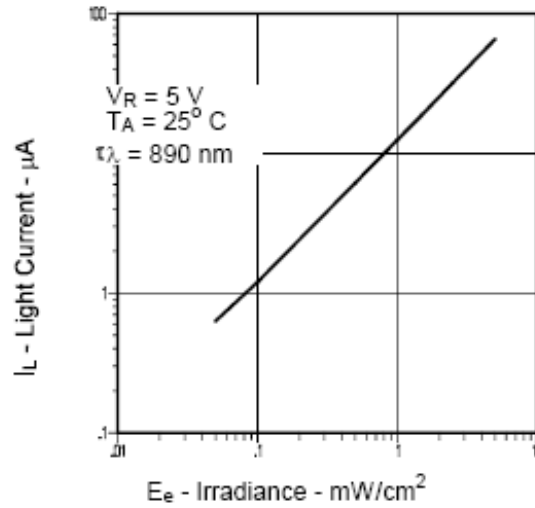

### Light Current vs. Angular Displacement

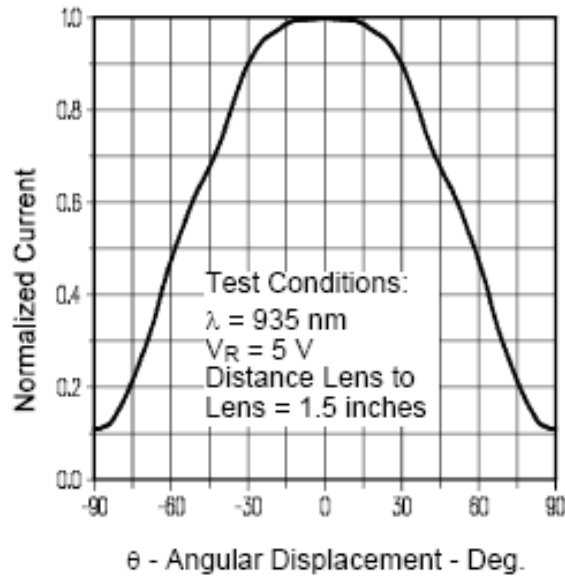

# PIN Silicon Photodiode

OP993, OP999



## OP999

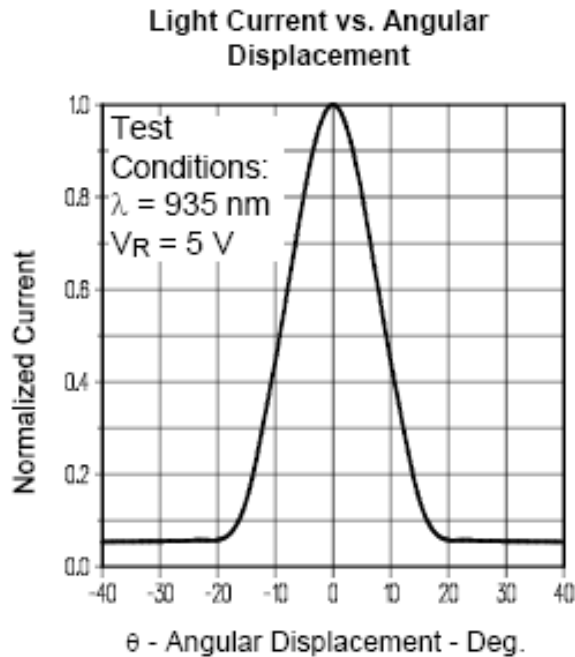
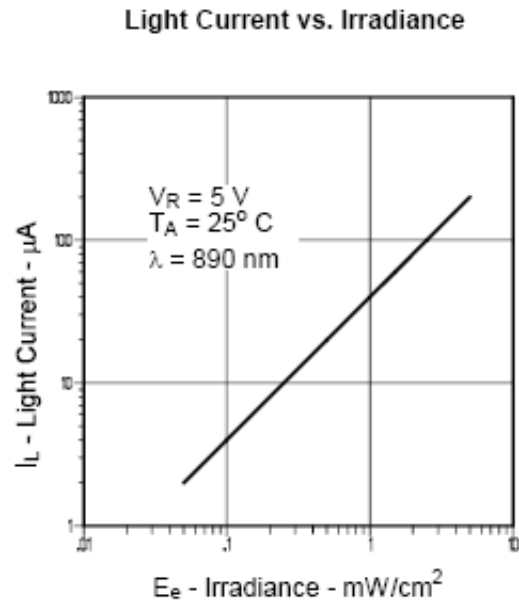
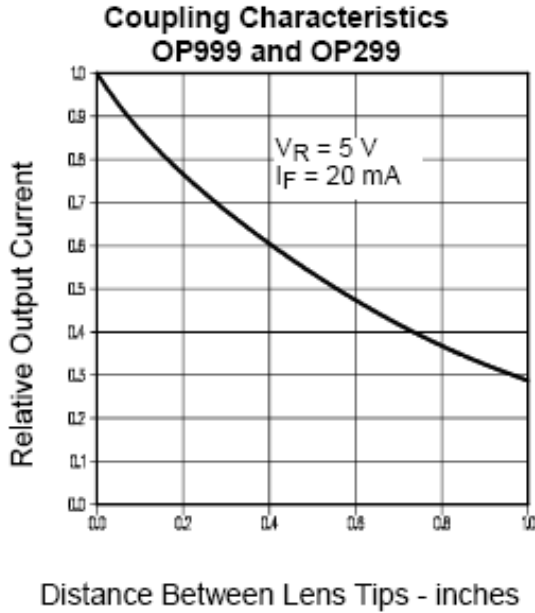

General Note  
TT Electronics reserves the right to make changes in product specification without notice or liability. All information is subject to TT Electronics' own data and is considered accurate at time of going to print.

OPTEK Technology, Inc.  
1645 Wallace Drive, Carrollton, TX 75006 | Ph: +1 972 323 2200  
www.optekinc.com | www.ttelectronics.com

# PIN Silicon Photodiode

OP993, OP999



Relative Response vs. Wavelength

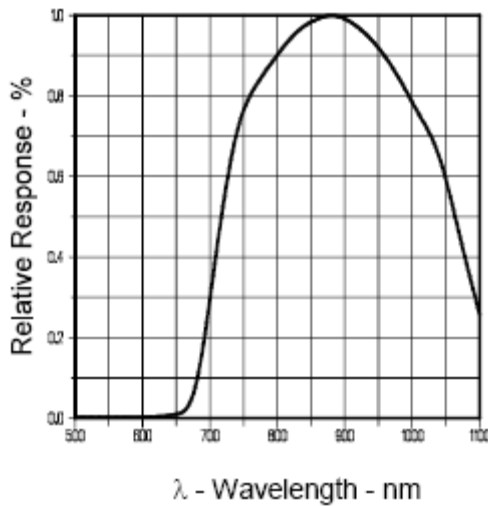

Normalized Light Current vs Reverse Voltage

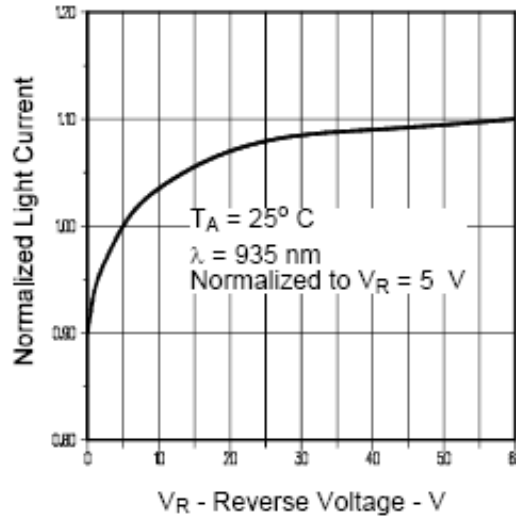

Total Capacitance vs Reverse Voltage

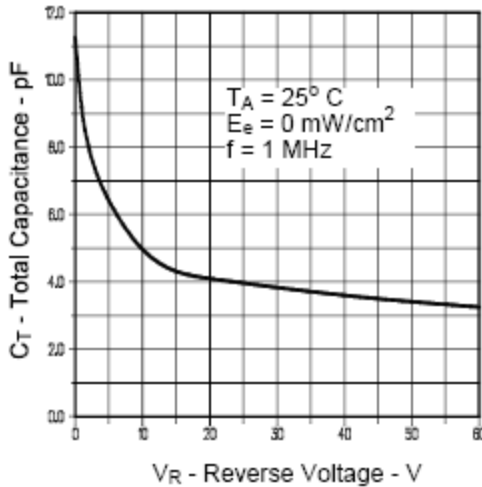

Normalized Light and Dark Current vs Ambient Temperature

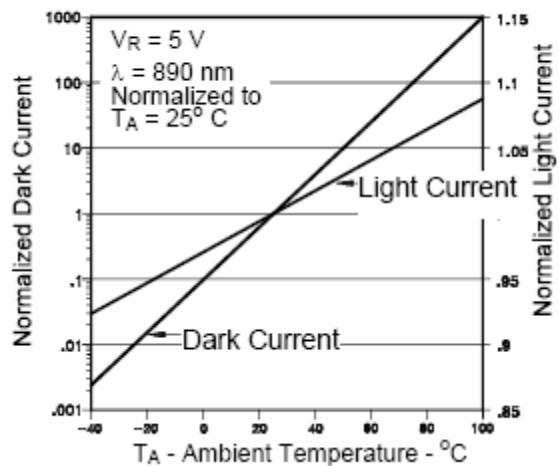

General Note  
TT Electronics reserves the right to make changes in product specification without notice or liability. All information is subject to TT Electronics' own data and is considered accurate at time of going to print.

OPTEK Technology, Inc.  
1645 Wallace Drive, Carrollton, TX 75006 | Ph: +1 972 323 2200  
www.optekinc.com | www.ttelectronics.com