



Chipsmall Limited consists of a professional team with an average of over 10 year of expertise in the distribution of electronic components. Based in Hongkong, we have already established firm and mutual-benefit business relationships with customers from,Europe,America and south Asia,supplying obsolete and hard-to-find components to meet their specific needs.

With the principle of "Quality Parts,Customers Priority,Honest Operation,and Considerate Service",our business mainly focus on the distribution of electronic components. Line cards we deal with include Microchip,ALPS,ROHM,Xilinx,Pulse,ON,Everlight and Freescale. Main products comprise IC,Modules,Potentiometer,IC Socket,Relay,Connector.Our parts cover such applications as commercial,industrial, and automotives areas.

We are looking forward to setting up business relationship with you and hope to provide you with the best service and solution. Let us make a better world for our industry!



Contact us

Tel: +86-755-8981 8866 Fax: +86-755-8427 6832

Email & Skype: info@chipsmall.com Web: www.chipsmall.com

Address: A1208, Overseas Decoration Building, #122 Zhenhua RD., Futian, Shenzhen, China



Photologic® Optical Flag Switch

OPB685, OPB685-3, OPB686, OPB687,
OPB688, OPB695, OPB696, OPB697, OPB698
Series

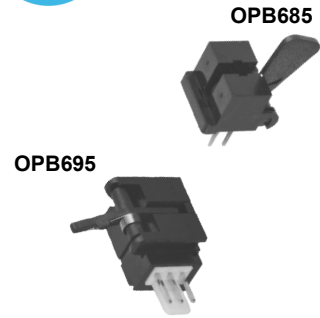

Features:

- Photologic® output
- Four output options
- Mechanical switch replacement
- Printed circuit board mounting (OPB685 Series)
- 2.5mm, 3-pin connector mates with Molex connector 5051 series housing and 4809 series terminal for OPB695 Series

Description:

Each **OPB685** and **OPB695** series flag switch consists of an infrared emitting diode and a monolithic integrated circuit that incorporates a photodiode, a linear amplifier and a Schmitt trigger. A lever arm actuated flag interrupts the light beam, which switches the output between states that can readily drive logic gates.

The **OPB695** series is designed to easily snap mount into a 0.037" ± 0.001" (0.940 mm ± 0.025 mm) thick material with a rectangular opening of 0.320" ± 0.003" x 0.472" (8.13 mm x 11.99 mm) minimum. Insertion into the punched side of metal is recommended.

Devices in these series feature TTL/LSTTL compatible logic level output that can drive up to 10 TTL loads over a voltage range from 4.5 V to 16 V.

Customized lever arms and spring torques can be designed for specific applications for each of the devices.

Custom electrical, wire, cabling and connectors are available. Contact your local representative or OPTEK for more information.

Applications:

- Mechanical switch replacement
- Speed indication (tachometer)
- Mechanical limit indication
- Edge sensing

Ordering Information					
Part Number	LED Peak Wavelength	Sensor Photologic®	Flag Travel Degrees Max	Lead Length / Spacing or Connector	
OPB685	890 nm	10K Pull-Up	59°	0.100" / 0.275"	
OPB686		Open Collector			
OPB687		Inv. 10K Pull-Up			
OPB688		Inv. Open Collector			
OPB695AZ		890 nm	10K Pull-Up	70°	Mates with 3 Pin—Molex 5051 (22-01-1032) Housing & 4809 (08-70-0069) Terminals
OPB695BZ					
OPB695CZ					
OPB696AZ			Open Collector		
OPB696BZ					
OPB696CZ					
OPB697AZ			Inv. 10K Pull-Up		
OPB697BZ					
OPB697CZ					
OPB698AZ		Inv. Open Collector			
OPB698BZ					
OPB698CZ					



General Note
TT Electronics reserves the right to make changes in product specification without notice or liability. All information is subject to TT Electronics' own data and is considered accurate at time of going to print.

OPTEK Technology, Inc.
1645 Wallace Drive, Carrollton, TX 75006
Ph: +1 972 323 2200
www.optekinc.com | www.ttelectronics.com

Photologic® Optical Flag Switch



OPB685, OPB685-3, OPB686, OPB687,
OPB688, OPB695, OPB696, OPB697,
OPB698 Series

OPB685, OPB685-3, OPB686, OPB687, OPB688

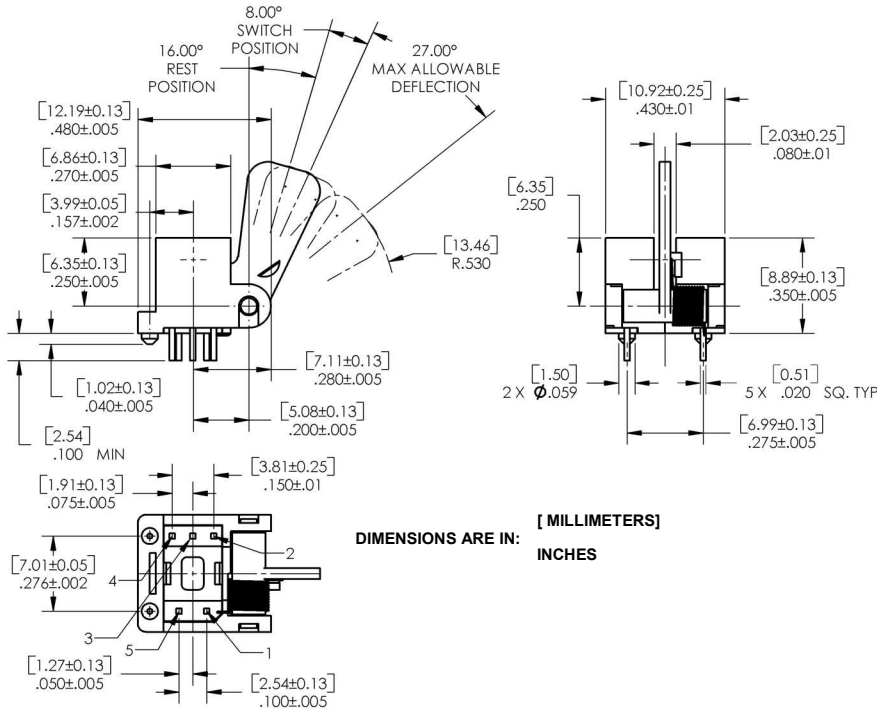

Pin #	Description
1	Anode
5	Cathode
2	Ground
3	Output
4	V _{CC}

OPB695, OPB696, OPB697, OPB698

Part Number	Max. Torque (Grams)
OPB685	1.5
OPB685-3	3.0
OPB686	1.5
OPB687	1.5
OPB688	1.5
OPB695	1.5
OPB696	1.5
OPB697	1.5
OPB698	1.5

Torque is measured at the end of the arm from the resting position to the switching point of the flag

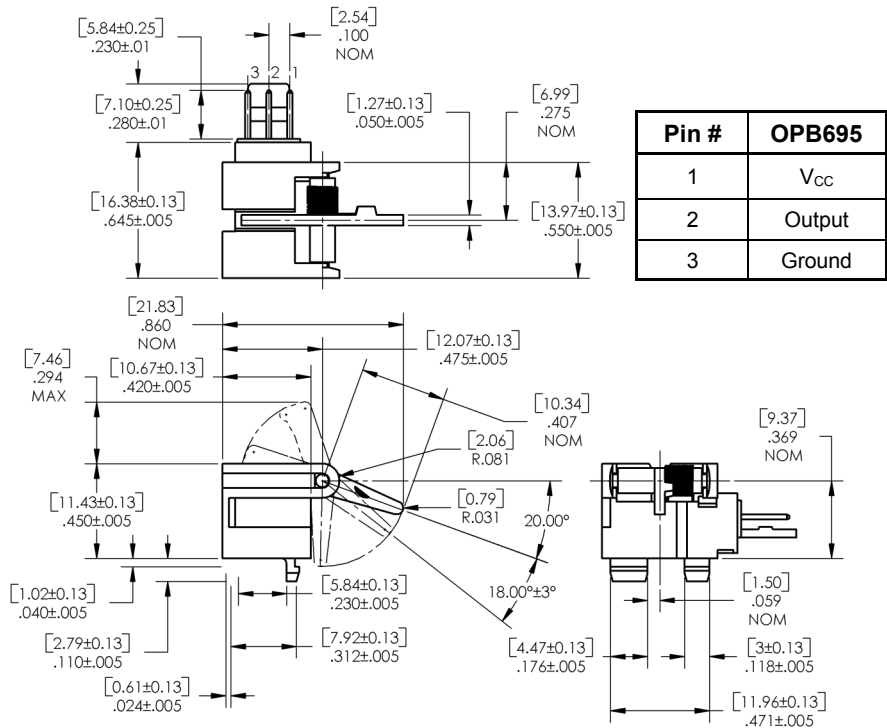

Pin #	OPB695
1	V _{CC}
2	Output
3	Ground

General Note
TT Electronics reserves the right to make changes in product specification without notice or liability. All information is subject to TT Electronics' own data and is considered accurate at time of going to print.

OPTEK Technology, Inc.
1645 Wallace Drive, Carrollton, TX 75006 | Ph: +1 972 323 2200
www.optekinc.com | www.ttelectronics.com

Photologic® Optical Flag Switch

OPB685, OPB685-3, OPB686, OPB687,
OPB688, OPB695, OPB696, OPB697,
OPB698 Series



Absolute Maximum Ratings ($T_A = 25^\circ\text{C}$ unless otherwise noted)	
Storage & Operating Temperature Range	-40°C to +100°C
Lead Soldering Temperature [1/16 inch (1.6mm) from the case for 5 sec. with soldering iron] ⁽¹⁾	260°C
Input Diode	
Reverse Voltage	2.0 V
Continuous Forward Current	50 mA
Peak Forward Current	3.0 A
Total Device Power Dissipation ⁽²⁾	100 mW
Output Photologic®	
Supply Voltage, V_{CC}	18 V
Duration of Output Short to V_{CC}	1 second
Voltage at Output	30 V
Low Level Output Current (sinking)	16 mA
Power Dissipation ^{(3) (4)}	240 mW

Notes:

- (1) RMA flux is recommended. Duration can be extended to 10 seconds maximum when flow soldering.
- (2) Derate linearly 1.33 mW/°C above 25° C.
- (3) Derate linearly 2.00 mW/°C above 25° C (OPB680, OPB680-20, OPB690Z).
- (4) Derate linearly 2.50 mW/°C above 25° C (OPB685, OPB686, OPB687, OPB688, OPB695, OPB696, OPB697, OPB698).

Photologic® Optical Flag Switch

OPB685, OPB685-3, OPB686, OPB687,
OPB688, OPB695, OPB696, OPB697,
OPB698 Series



OPB685 and OPB695 Series

OPB685, OPB695 Buffered 10K Pull-Up

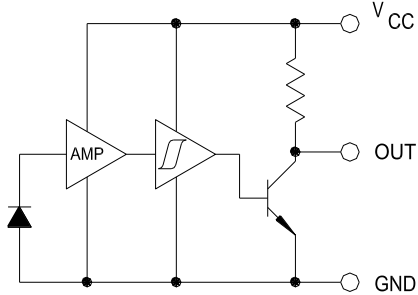

OPB686, OPB696 Buffered Open-Collector

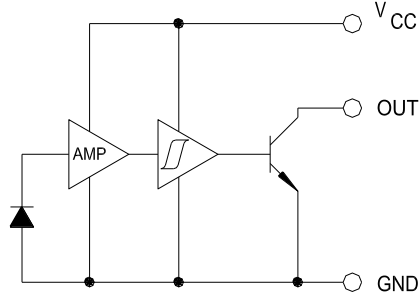

OPB687, OPB697 Inverted 10K Pull-Up

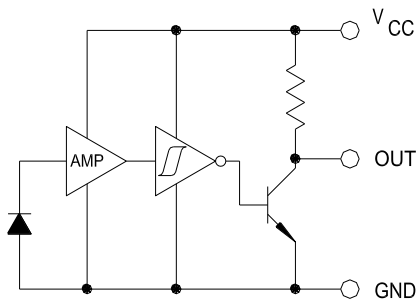

OPB688, OPB698 Inverted Open-Collector

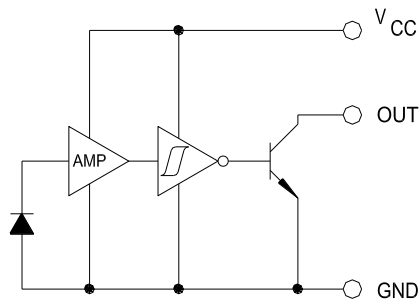

General Note
TT Electronics reserves the right to make changes in product specification without notice or liability. All information is subject to TT Electronics' own data and is considered accurate at time of going to print.

OPTEK Technology, Inc.
1645 Wallace Drive, Carrollton, TX 75006 | Ph: +1 972 323 2200
www.optekinc.com | www.ttelectronics.com

Photologic® Optical Flag Switch

OPB685, OPB685-3, OPB686, OPB687,
OPB688, OPB695, OPB696, OPB697,
OPB698 Series



Electrical Characteristics (T _A = 25° C unless otherwise noted)							
SYMBOL	PARAMETER	MIN	TYP	MAX	UNITS	TEST CONDITIONS	
Input Diode							
V _F	Forward Voltage	-	-	1.6	V	I _F = 10 mA	
I _R	Reverse Current	-	-	100	μA	V _R = 3 V	
Output Photologic® Sensor							
V _{CC}	Operating DC Supply Voltage						
	OPB685 Series	4.5	-	16.0	V		
	OPB695-698A	4.5	5.0	8.0			
	OPB695-698B	8.0	12.0	13.5			
OPB695-698C	13.5	15.0	16.0				
I _{CC}	Operating DC Supply Current OPB695-698A/B/C	-	20	30	mA		
I _{CCL}	Low Level Supply Current:						
	Buffered 10k Pull-Up	OPB685	-	5.5	12	mA	V _{CC} = 16 V, I _F = 0 mA (no load on output)
	Buffered Open-Collector	OPB686	-	4.0	12		
	Inverted 10k Pull-Up	OPB687	-	6.5	12	mA	V _{CC} = 16 V, I _F = 10 mA (no load on output)
Inverted Open-Collector	OPB688	-	5.0	12			
I _{CCH}	High Level Supply Current:						
	Buffered 10k Pull-Up	OPB685	-	5.0	12	mA	V _{CC} = 16 V, I _F = 10 mA (no load on output)
	Buffered Open-Collector	OPB686	-	5.0	12		
	Inverted 10k Pull-Up	OPB687	-	4.0	12	mA	V _{CC} = 16 V, I _F = 0 mA (no load on output)
Inverted Open-Collector	OPB688	-	4.0	12			
V _{OL}	Low Level Output Voltage ⁽¹⁾ :						
	Buffered 10k Pull-Up	OPB685	-	-	0.4	V	V _{CC} = 4.5 V, I _{OL} = 16 mA, I _F = 0 V _{CC} = 4.5 V to 8 V, I _{OL} = 16 mA V _{CC} = 8.5 V to 13 V, I _{OL} = 16 mA V _{CC} = 13.5 V to 16 V, I _{OL} = 16 mA
	Buffered Open-Collector	OPB686	-	-	0.4		
		OPB695	-	-	0.4		
		OPB696A/B/C	-	-	0.4		
	Inverted 10k Pull-Up ⁽²⁾	OPB685	-	-	0.4	V	V _{CC} = 4.5 V, I _{OL} = 16 mA, I _F = 0 V _{CC} = 4.5 V to 8 V, I _{OL} = 16 mA V _{CC} = 8.5 V to 13 V, I _{OL} = 16 mA V _{CC} = 13.5 V to 16 V, I _{OL} = 16 mA
		OPB686	-	-	0.4		
	Inverted Open-Collector	OPB695	-	-	0.4		
	OPB696A/B/C	-	-	0.4			
V _{OH}	High Level Output Voltage ⁽²⁾ :						
	Buffered 10k Pull-Up		V _{CC}	-	-	V	I _{OH} = 100 μA, I _F = 10 mA
	Inverted 10k Pull-Up ⁽¹⁾		V _{CC}	-	-	V	I _{OH} = 100 μA, I _F = 0 mA
	Inverted Open-Collector		-1.5	-	-		
I _{OH}	High Level Output Current ⁽²⁾ :						
	Buffered Open-Collector	OPB686	-	-	100	μA	V _{CC} = 16 V, I _F = 10 mA, V _{CH} = 30 V V _{CC} = 4.5 V to 8 V, V _{OH} = 30 V V _{CC} = 8.5 V to 13 V, V _{OH} = 30 V V _{CC} = 13.5 V to 16 V, V _{OH} = 30 V
		OPB696A	-	-	100		
		OPB696B	-	-	100		
		OPB696C	-	-	100		
		Inverted 10k Pull-Up ⁽¹⁾	OPB688	-	-	100	μA
		OPB698A	-	-	100		
		OPB698B	-	-	100		
		OPB698C	-	-	100		

General Note
TT Electronics reserves the right to make changes in product specification without notice or liability. All information is subject to TT Electronics' own data and is considered accurate at time of going to print.

OPTEK Technology, Inc.
1645 Wallace Drive, Carrollton, TX 75006
Ph: +1 972 323 2200
www.optekinc.com | www.ttelectronics.com

Photologic® Optical Flag Switch

OPB685, OPB685-3, OPB686, OPB687,
OPB688, OPB695, OPB696, OPB697,
OPB698 Series



Electrical Characteristics (T _A = 25° C unless otherwise noted)						
SYMBOL	PARAMETER	MIN	TYP	MAX	UNITS	TEST CONDITIONS
Output Photologic® Sensor (continued)						
I _{F(+)}	LED Positive-Going Threshold Current OPB685-688	0.1	1.8	10	mA	V _{CC} = 5 V
I _{F(+)} /I _{F(-)}	Hysteresis OPB685/688	1.0	1.2	1.6	mA	V _{CC} = 5 V
t _r ,t _f	Rise Time, Fall Time	-	30	-	ns	V _{CC} = 5 V, I _F = 0 or 10 mA R _L = 300 Ω, DC = 50% f = 10 kHz
t _{PLH} t _{PHL}	Propagation Delay Low-High & High-Low: Buffer, 10k Pull-Up OPB685	-	1 _(LH)	-	μs	
	Buffer, Open-Collector OPB686	-	2 _(HL)	-	μs	
	Inverter, 10k Pull-Up OPB687	-	2 _(LH)	-	μs	
	Inverter, Open-Collector OPB688	-	1 _(HL)	-	μs	

Notes:

- (1) Test requires lever arm in “blocked” position.
- (2) Test requires lever arm in “unblocked” position